

STATE OF CALIFORNIA  
MARINE RESEARCH COMMITTEE

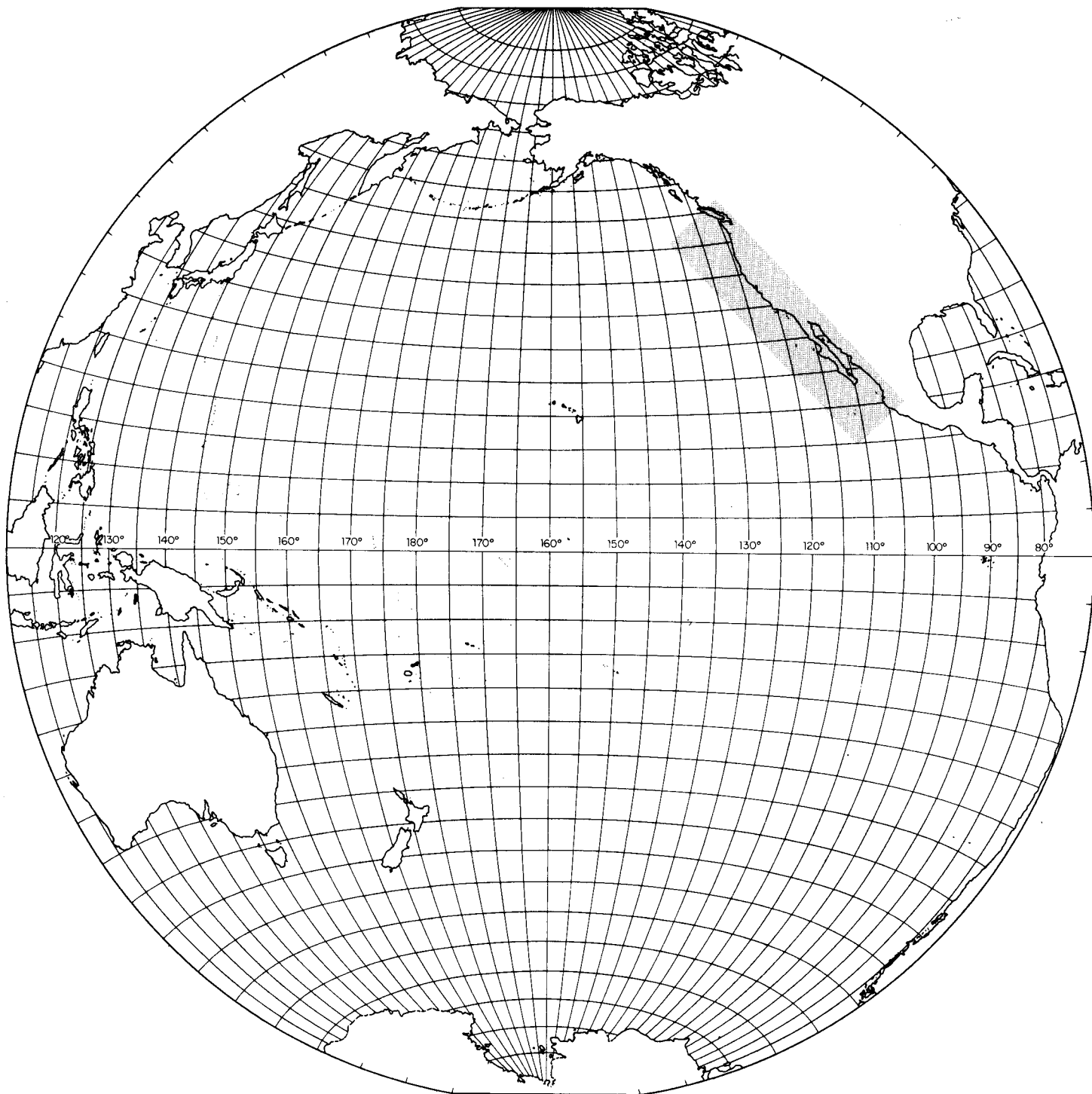

# CALIFORNIA COOPERATIVE OCEANIC FISHERIES INVESTIGATIONS

## REPORTS

VOLUME X  
JANUARY 1965

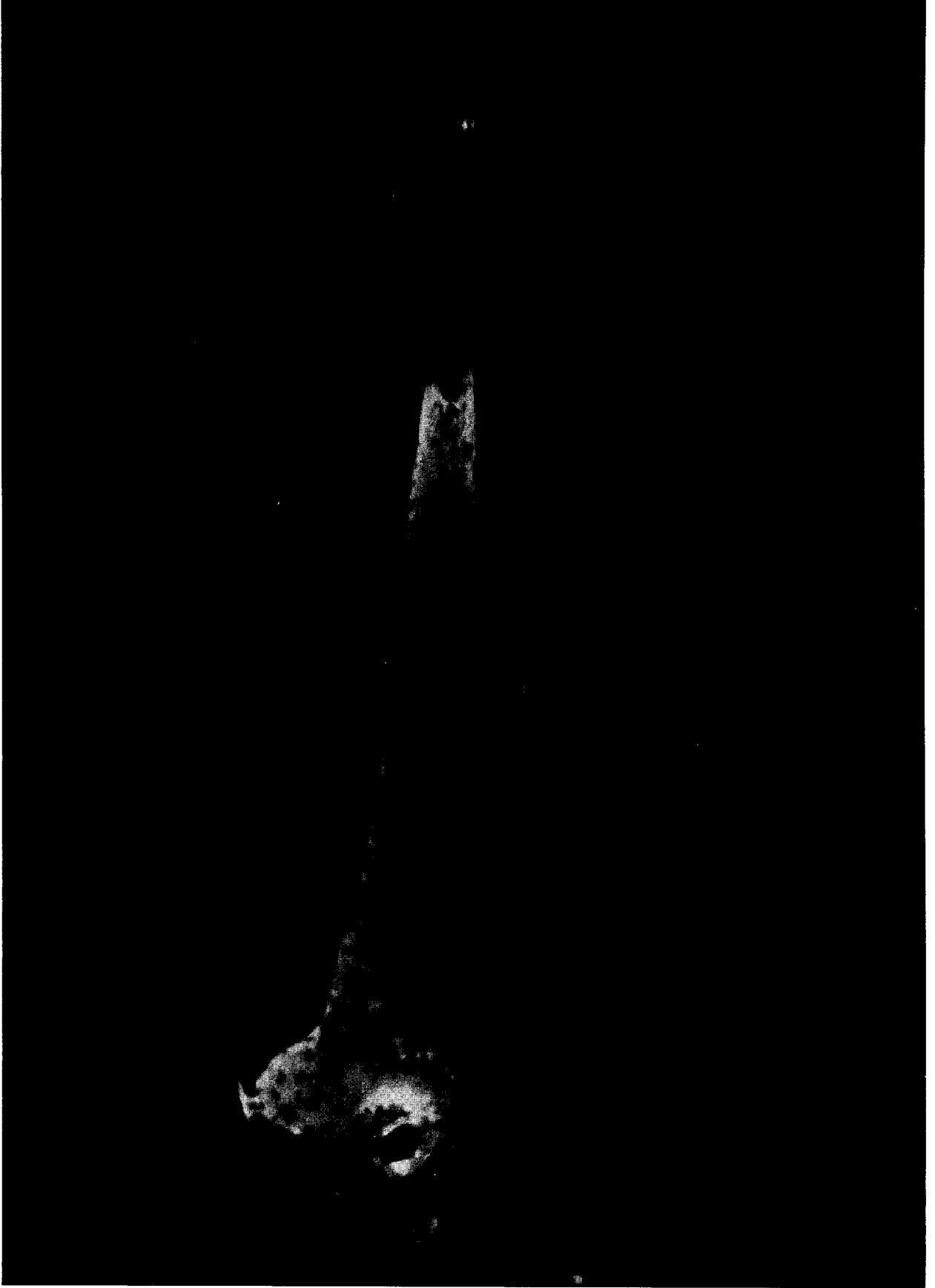

*Pleuronichthys verticalis*: Top, newly hatched, 3.1 mm long; bottom, about six days old, 3.35 mm long.  
(George Mattson, U.S. Bureau of Commercial Fisheries.)



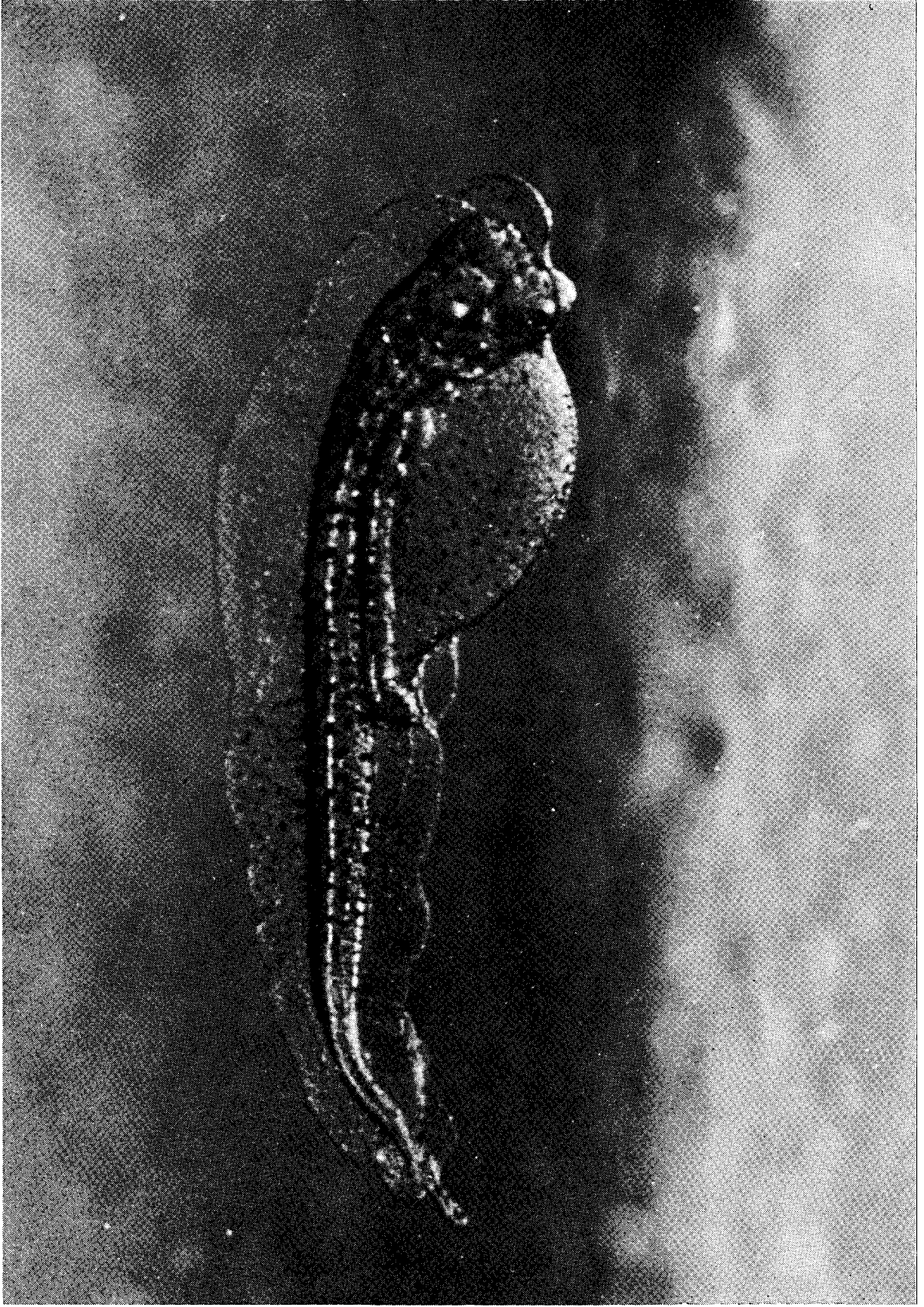

Larva of *Pleuronicichthys verticalis* Hornyhead turbot newly hatched 3.1 mm.

STATE OF CALIFORNIA  
DEPARTMENT OF FISH AND GAME  
MARINE RESEARCH COMMITTEE

CALIFORNIA  
COOPERATIVE  
OCEANIC  
FISHERIES  
INVESTIGATIONS

*Reports*

Volume X

1 July 1962 to 30 June 1963

**Cooperating Agencies:**  
CALIFORNIA ACADEMY OF SCIENCES  
CALIFORNIA DEPARTMENT OF FISH AND GAME  
STANFORD UNIVERSITY, HOPKINS MARINE STATION  
U. S. FISH AND WILDLIFE SERVICE, BUREAU OF COMMERCIAL FISHERIES  
UNIVERSITY OF CALIFORNIA, SCRIPPS INSTITUTION OF OCEANOGRAPHY

1 January 1965

EDITORIAL BOARD  
GARTH I. MURPHY (Chairman)  
E. H. AHLSTROM  
J. D. ISAACS  
JOHN RADOVICH

## LETTER OF TRANSMITTAL

January 1, 1964

EDMUND G. BROWN  
*Governor of the State of California*  
*Sacramento, California*

Dear Sir: We respectfully submit the tenth report on the work of the California Cooperative Oceanic Fisheries Investigations.

The report consists of two sections. The first contains a brief review of the administrative and research activities during the period July 1, 1962 to June 30, 1963, a description of the fisheries, and a list of publications arising from the programs. The second section is comprised of original scientific contributions. In this volume the bulk of these are the paper prepared for a special symposium on larval fish biology.

Respectfully,

The Marine Research Committee

J. G. BURNETTE, Chairman

EDWARD F. BRUCE, Vice Chairman

J. J. BOGDANOVICH

C. R. CARRY

W. M. CHAPMAN

R. E. CHAPMAN

JACK GORBY

JOHN HAWK

ARTHUR H. MENDONCA

## CONTENTS

	Page
I. Review of Activities	
1. Review of Activities July 1, 1962–June 30, 1963	1
2. Review of pelagic wet fisheries during the 1960–61 season	8
3. Publications	10
II. Scientific Contributions	
1. Symposium on larval fish biology	12
Preface	12
a. On the importance of larval survival for the population dynamics of marine food fish Gotthilf Hempel	13
b. Problems of fish larvae survival in nature and the rearing of economically important middle European freshwater fishes Wilhelm Einsele	24
c. Kinds and abundance of fishes in the California Current region based on egg and larval surveys Elbert H. Alstrom	31
d. Rearing marine fish for commercial purposes James E. Shelbourne	53
e. Functional development of visual pathway in larval sardines and anchovies Horst O. Schuassman	64
f. Some aspects of behavior in clupeid larvae George O. Schumann	71
g. The feeding of herring larvae and their ecology in relation to feeding J. H. S. Blaxter	79
h. Osmoregulation in marine teleost eggs and larvae F. G. T. Holliday	89
i. The physiology of Pacific sardine embryos and larvae Reuben Lasker	96
j. Larval sardine and anchovy interrelationships John D. Isaacs	102
2. Climatic implications derived from the comparison of bathythermograph (BT) data with two types of historic and modern sea surface data Margret K. Robinson	141



## PART I

# REVIEW OF ACTIVITIES

July 1, 1962–June 30, 1963

## REPORT OF THE CALCOFI COMMITTEE

There is a unique relation between the recreational and food fishing industries, the public and the research organizations in the California Cooperative Oceanic Fisheries Investigations, made possible by the Marine Research Committee of the State of California. The research organizations represent as wide a variety of skills as has ever been brought to bear on fisheries problems.

One of the important contributions of the Marine Research Committee has been the sponsorship of the series of reports, of which this is the tenth. Through this medium some of the scientific results are made available to a rather wide audience. Most of this volume of the Reports is given over to the publication of papers presented at a Larval Fish Symposium, held as part of the CalCOFI Conference at Lake Arrowhead on October 28 to 30, 1963. This is the third symposium that has been published in CalCOFI Reports. The first was the important symposium on "The Changing Pacific Ocean in 1957 and 1958," edited by Sette and Isaacs and published in Volume VII, pp 13–217 (January 1960). A "Symposium on Fisheries Oceanography," edited by Maurice Blackburn, was included in the succeeding volume (Vol. VIII of the Reports, pp 19–74 (January 1961)).

The ocean research conducted under CalCOFI has been coordinated research—hydrographic observations and studies are made concurrently with biological programs. Although this is a logical way of conducting oceanographic-environmental research, it has seldom been attempted in other fishery investigations.

Ocean research at the inception of CalCOFI centered on the environment of the Pacific sardine. We were soon able to demonstrate that it is possible to define and delimit the spawning range and season of a widely distributed pelagic species, such as the sardine and to follow its year by year changes in distribution and abundance. Sardine spawning was found to have both an extensive distribution and a variable one, requiring the systematic coverage of rather extensive oceanic areas off California and Baja California.

This coverage also afforded information on the young of other pelagic fishes in the California Current region—on anchovy, jack mackerel, Pacific mackerel, hake, saury, rockfishes, and flatfishes. In fact, it soon became evident that the surveys were one of the more effective methods available for resource evaluation.

The similarity in the distribution of the eggs and larvae of the northern anchovy and the Pacific sar-

dine was noted early in the CalCOFI surveys. The young stages of both species were distributed mainly between Pt. Conception, California and Pt. San Juanico, Baja California. Although anchovy eggs and larvae were taken more consistently off central and northern California than the young stages of sardine, numbers were few to moderate. The two species had essentially the same spawning distributions.

In the last two volumes of Reports, the CalCOFI Committee has reported on the marked increase in anchovy abundance that has occurred in recent years, and the apparent take-over by the anchovy of much of the ecological niche formerly occupied by the sardine. More information is now available, which strengthens the hypothesis of interaction between these two species.

During the decade of the 1950's, the number of anchovy larvae obtained on CalCOFI survey cruises increased markedly: abundance in 1958 and 1959 was three times as great as in 1951. During the same period the number of sardine larvae decreased, especially after 1954. The ratio of anchovy to sardine larvae was about 3 to 1 in 1951; by 1956 anchovy larvae outnumbered sardine by nearly 10 to 1, and in 1959 by about 45 to 1. During the four quarterly cruises of 1962, there were 80 times as many anchovy larvae collected as sardines. The spring cruise of 1962 (6204–05) yielded the largest number of anchovy larvae ever taken on a single cruise. Based on standard haul totals, the number of anchovy larvae taken on this one cruise was about as great as the total number taken in all cruises of 1956, and greater than the combined totals for anchovy larvae for 1950, 1951, and 1952, so great has been the increase in abundance of this species. Anchovy larvae, as they have increased in abundance, have become distributed over a larger area, especially in the offshore waters off southern California, and have tended to co-occur more frequently with sardines. In 1958, 94 percent of sardine larvae were taken in hauls containing anchovy larvae, and the latter outnumbered the sardine larvae in these hauls by about 10 times. The disproportion between anchovy and sardine larvae had further increased by about 5-fold in the hauls where they co-occurred during the spring cruise of 1962.

Had the CalCOFI research been other than the broadly based environmental program we have followed, it is doubtful whether the interaction between the sardine and anchovy populations could have been

appreciated or documented, nor the associated environmental changes understood.

At the inauguration of the CalCOFI program we wished to test the widely held hypothesis that the marked fluctuations in survival of marine pelagic fishes was controlled by the oceanic environment. Oceanic environmental factors constitute an amorphous assemblage, but the factors usually considered to be the critical influences on the survival of the young stages of fishes include such physical hydrographic variables as temperature, density, turbulence, upwelling, currents, and such broadly-based biological factors as productivity.

The upper mixed layer is the zone in which the eggs and larvae of most pelagic fishes occur, hence is the part of the ocean in which we are primarily interested. In this layer most oceanographic features have one thing in common, they are constantly varying—changing with the season and varying from year to year.

The influence of physical environmental factors, such as temperature on the place and time of spawning of pelagic marine fishes is readily demonstrable. The differences between such years as 1956 and 1958 on the time and place of sardine spawning off southern California are especially striking.

We also began to look at our sardine data from earlier years more critically. It became evident that a large sardine population, such as in the early 1940's, had a depressing effect on year classes. Best survival occurred at middling population size, such as produced the strong 1939 year class. With the increase of the anchovy population it began to appear as though the adult anchovy and sardine stocks were acting together to influence survival in essentially the same ways as had large sardine populations.

This is an environmental influence, but a different and more subtle kind than had originally been envisaged. Instead of some variable physical conditions being the primary factor influencing survival of year classes, the basic agent may be adult filter feeding fishes.

We have now reached the stage in our investigations where we have an exciting and important hypothesis to test—the interaction or competition of pelagic species occupying the same trophic level.

To test this hypothesis we need more precise information on competition between species in the ecosystem. There are a number of gaps in our data that need to be filled. For one thing, we need to sample anchovy eggs quantitatively. The sampling of other stages must also be improved. The technical aspects of sampling are bottlenecks that are being actively studied and have to be solved, if we are to engage in more sophisticated studies of the competition between the young stages of sardines and anchovies. Some of the studies will require carefully planned experiments carried out at sea, others will have to be done under controlled experimentation in the laboratory. For carrying out the latter, it is essential that we be able to rear the larval stages of sardines and anchovies in the laboratory.—*E. H. Ahlstrom, J. L. Baxter, J. D. Isaacs, and G. I. Murphy.*

## AGENCY REPORT FOR CALCOFI PROGRESS REPORT—VOLUME X

### *California Department of Fish and Game*

The Department through its Pelagic Fish Program conducts research on the pelagic wet fisheries (those canned raw) with emphasis on Pacific sardines, Pacific mackerel, jack mackerel and northern anchovies. The two projects comprising the Program are (i) the Fisheries Investigations Project and (ii) the Sea Survey Project. Our overall objective is, "To assess the size, distribution, and age structure of the sardine, Pacific mackerel, jack mackerel, anchovy and other important pelagic fish populations and to develop an understanding of the dynamics of the populations relative to their management."

Our Fisheries Investigations Project studies the commercial and live bait catches, including sampling for size and age composition, and analyzing catch statistics, to measure trends in the fisheries. These data are necessary to understand population dynamics.

Our continuing catch statistics study includes monitoring, compiling, and editing source data, and determining the amounts and kinds of fish used as live bait.

The four major species, sardines, jack mackerel, Pacific mackerel, and anchovies, are sampled on a continuing basis for age composition to measure the sizes of year-classes in the fisheries. Determining ages for the sardine and anchovy catches is done in cooperation with the U.S. Bureau of Commercial Fisheries. Two publications resulted during 1962–63, and work was initiated to reduce a large backlog of jack mackerel age data.

We continued measuring fishing effort and determining fishing localities by interviewing fishermen and examining log books. Sardine catch-per-effort data for the years 1953–54 through 1959–60 were programmed and run through electronic computers. When these data are fully analyzed, we anticipate preparing a paper describing the results.

Monthly aerial surveys designed to measure the relative abundance and distribution of inshore pelagic fish schools, particularly anchovies, continued. A paper on aerial survey methods, along with data for the years 1954 through 1963, was being prepared.

We also continued a sardine morphometric study to determine if the known races can be separated by measurable physical differences. Measurements and counts have been completed on about 5,000 sardines and the data are being prepared for detailed statistical analyses.

The Sea Survey Project's major effort was directed toward changing the survey's scope from one concerned primarily with sardines to an overall investigation of the organisms in the pelagic environment. Principally, this called for developing new gear that would adequately sample species ineffectively sampled or completely missed in the past. To this end, a midwater trawl with a 50-foot-square mouth opening was designed in August, 1962 and has been used successfully since. The midwater trawl has taken an increasingly important place in our surveys and will be

our principal sampling device in the future, with the previously used blanket-net relegated to a secondary sampling tool. The midwater trawl is already producing much-improved information on the abundance and distribution of anchovies and jack mackerel, as well as being adequate for sardines and Pacific mackerel.

The routine sea survey in the fall of 1962 included three cruises covering the coastal waters from southern Baja California to Point Conception, California. Midwater trawl and night-light stations were occupied throughout this area, with both methods producing similar results. The survey generally found sardines very scarce everywhere, with especially low levels in California and northern Baja California. Fish-of-the-year were virtually non-existent. In contrast, anchovies, both young and old, were abundant everywhere.

In addition to the routine fall survey cruises, some special cruises were made. The first of these was a 30-day trip to Vancouver Island, British Columbia, in July and August 1962. We hoped to uncover some remnants of the sardine stock that once abounded there, and thus determine if they were the same or a different stock than sardines now found in California. Unfortunately no sardines could be located, so the question remains unanswered.

Two other special cruises were made to northern and central California in May and June 1963. These were primarily midwater-trawl surveys to determine what kinds of organisms occupy the pelagic environment there. Interesting hake, osmerid (smelt), and salmon catches were made in northern California. The central California cruise was incomplete because the midwater trawl was lost near San Francisco early in the cruise.

Finally, we started making a detailed analysis of past sea survey data concerning sardines. This work has progressed to the point where area-weighting factors, which reflect the size of an area in terms of the amount of biologically suitable sardine habitat it contains, must be calculated before the data for individual areas can be combined. Once this is done, the sardine populations can be considered as whole units and an analysis can proceed. Attempts thus far to obtain these factors with the aid of a computer have been generally unsatisfactory; therefore, other techniques will have to be considered.

#### **Hopkins Marine Station**

In the period July 1, 1962–June 30, 1963, the Hopkins Marine Station of Stanford University has continued to monitor the marine climate and plankton in the Monterey Bay area. Approximately weekly cruises were made on Monterey Bay, daily shore temperatures were reported from Pacific Grove and Santa Cruz, and once a month shore temperatures were taken at selected stations along the coast between Monterey and Morro Bay. The data collected in these operations have been compiled and distributed to interested agencies and individuals in the form of mimeographed quarterly and annual data reports.

#### **California Academy of Sciences**

Experimental studies of the natural responses of the Northern Anchovy to light waves were completed and the results of these studies were incorporated in a manuscript in press.

Continuing studies included re-analysis of all data on the responses of sardines and anchovies to electric fields, and the response of these species to vibrations. At certain frequencies the sardine orients itself away from the source and swims away while the anchovy does the opposite.

In cooperation with the California Department of Fish and Game field observations were made on the schooling behavior of a number of pelagic fishes.

#### **La Jolla Biological Laboratory**

The La Jolla Biological Laboratory of the U.S. Bureau of Commercial Fisheries is engaged in research on pelagic marine fishes of the California Current system, exclusive of tunas. The laboratory conducts most of its sea programs in cooperation with the Scripps Institution of Oceanography, investigates the age and size composition of sardines cooperatively with the California Department of Fish and Game, and conducts sampling of the sardine fishery of Baja California through a contract with the California Academy of Sciences. The program of broadly-based research includes such varied disciplines as physiology, biochemistry, fish taxonomy, plankton and fish behavior, genetics, biometrics and ecology.

As an integral part of its research program, the laboratory operates the 150-foot research vessel, *Black Douglas*. In fiscal 1963 the *Douglas* was at sea 185 days on four quarterly Cal COFI survey cruises, two resource evaluation cruises and several special cruises for behavior studies, life history studies and problems in quantitative zooplankton sampling.

The *Black Douglas* and the *John N. Cobb* of the Bureau's Branch of Exploratory Fishing and Research Base, Seattle, teamed up for two cruises, one in August, 1962, the other in February–March, 1963 to study the composition and abundance of pelagic fish and to evaluate potential commercial fishery resources, especially the Pacific hake. On the second cruise, several areas of heavy hake spawning were located by taking plankton hauls for hake eggs along a predetermined cruise track from the *Black Douglas*. The crew of the *Cobb*, guided by this information, successfully sampled several concentrations of spawning adults at 80 to 180 fathoms below the surface in these localities employing the large Mark II pelagic trawl, which has a mouth opening of approximately 70 × 80 feet.

During the past fiscal year studies on blood antigens have revealed that in the Gulf of California there is a third subpopulation genetically distinct from the northern and southern subpopulations off the west coast of California and Baja California. The southern coastal population remained off Baja California and did not contribute significantly to the California commercial catch during the 1962–63 season.

A project to determine methods of rearing pelagic marine fish larvae was initiated as part of the physi-

ology program. A pilot study is underway in the Scripps experimental aquarium building, but because of space and equipment limitations, the studies are restricted in scope. Upon completion of the new laboratory with its sea water facilities, this problem will be alleviated. A research program dealing with plankton behavior was begun in the latter part of fiscal '63 with preliminary work on the avoidance of towed nets by zooplankters.

Utilizing a temperature-gradient block, an experimental study was made of the effect of temperature on the incubation time and development of embryos and early stage larvae of sardine and anchovy. It was shown that the anchovy can tolerate and develop normally in water as cold as 11°C, whereas the sardine does not develop normally below 13°C. A comparison of incubation times showed that the anchovy takes somewhat less time to develop to hatching than the sardine at all temperatures.

As part of a study of the energy balance for adult sardines, the physiology program has been studying oxygen consumption and carbon dioxide production of the sardine at different temperatures and under different swimming conditions. A metabolism tank permits the simultaneous recording of carbon dioxide production (measured by changes in pH) and oxygen consumption (measured with an oxygen electrode) in individual adult sardines. Adult sardines do not appear to "rest" but always maintain active swimming movements. Only when fish are severely strained and are unable to maintain headway against a current is there a distinct change in the oxygen uptake.

The study of sardine and anchovy behavior was carried out in a 31,000 gallon tank beneath the the Scripps pier. Observations were made on the quite different types of locomotion of the two species, and on a peculiar driving behavior which has been interpreted as aggressive action by individual sardines. Feeding activities were also studied as well as the initiation of the "feeding frenzy" exhibited by hungry fish. Gaping, or the wide distension of the mouth and gill covers for a few seconds at a time, was periodically exhibited by both sardines and anchovies, often following feeding. The reaction of anchovies to line barriers, made of black thread and translucent nylon monofilament was studied. For the smallest spacing used, 3 inches, the black thread was a more effective barrier than the monofilament.

The distribution and numbers of sardine eggs and larvae in the CalCOFI survey area during 1962 was investigated on four quarterly survey cruises. These cruises cover the spawning distribution of sardines in the eastern North Pacific, exclusive of the Gulf of California.

Sardine eggs were fewest in number and had the most restricted distribution since the inauguration of CalCOFI surveys in 1949; most of them were taken close to shore, at the inner stations on sampling lines. About 80 percent of occurrences were at such stations or within Sebastian Ciscaino Bay (central Baja California). Only about 5 to 6 percent of sardine eggs and larvae were taken off California, the remainder were

distributed off Baja California, especially off central Baja California.

Because of this inshore distribution of sardines, a change has been made in the inshore coverage on CalCOFI survey cruises, beginning with the April-May cruise of 1963. A total of 58 near-shore stations have been added to the inshore portions of the 25 station lines between San Francisco, California and Santa Maria Bay, off southern Baja California (lines 60-140). These stations are spaced within 2 to 4 miles of each other, and the innermost on each line is as close to shore as is compatible with water depth and vessel safety.

The distribution of anchovy eggs and larvae during 1962 offered a marked contrast to the sardine. During the first half of 1962, anchovy larvae occurred in 62% of all plankton hauls taken in the CalCOFI survey area; approximately 95% of the anchovy larvae sampled in 1962 were taken during these two cruises. During the second half of 1962, anchovy larvae occurred in 31% of the hauls, but constituted only 5 percent of the annual total. Anchovy larvae not only occurred in 8 times as many hauls as sardine larvae, but the average abundance per positive haul was nearly 10 times as great. Hence less than 2 percent as many sardine larvae were taken in 1962 as anchovy larvae. Furthermore, anchovy larvae occurred at all except 4 stations where sardine larvae were collected. Wherever sardine larvae presently occur they have to compete with a much larger group of anchovy larvae. The disparity in numbers between the two species was greatest during the first half of the year, and all hauls containing sardine larvae also contained anchovy larvae during these cruises.

Two major projects of the laboratory during the past fiscal year were the planning of a new research laboratory and of a new research vessel to replace the *Black Douglas*. The planning of the new facilities was carried out cooperatively with personnel of the BCF, San Diego Laboratory. The new laboratory, a four-building complex, is being constructed at the north end of Scripps campus on land donated to the Government by the Regents of the University of California. The new research vessel, to be named the *David Starr Jordan* after one of America's leading ichthyologists and first president of Stanford University, will have an overall length of 171 feet and a 36-foot beam. It will be constructed of welded steel with raked stem and transom stern with two partial decks below and two superstructure decks above the main deck. More than a third of the ship's enclosed area will be devoted to laboratories and scientific support areas.

#### ***Scripps Institution of Oceanography Marine Life Research Program***

The Marine Life Research Program is the University of California, Scripps Institute portion of the California Cooperative Oceanic Fisheries Investigations Program. Its efforts are broadly aimed at achieving an understanding of the currents, chemistry and creatures of the eastern North Pacific. The pri-

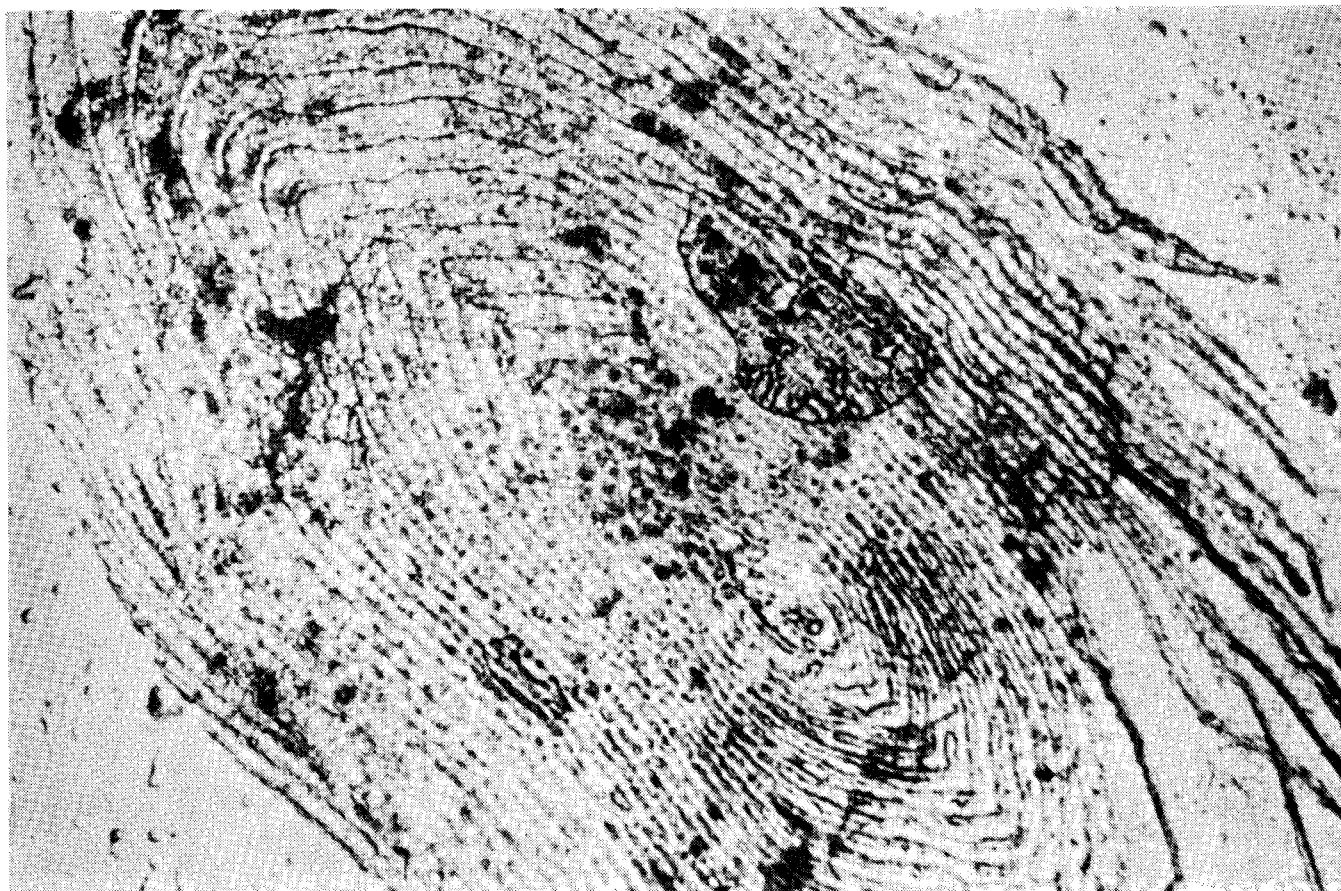

Example of fish scales from the sediments of the Santa Barbara Basin. A study of such scales recovered at different depths in these sediments may give insight into the relative abundance and fluctuations of abundance of various fish during the last few thousand years. The microfossils associated with the fish scales may record the way that the ocean currents varied during the same period.

many efforts of the Marine Life Research Program have been concerned with the near-surface waters of the California Current, but support from the National Science Foundation, Atomic Energy Commission, Bureau of Commercial Fisheries, the Office of Naval Research, the Marine Research Committee, and others, have greatly enriched the Program. This support has enabled the Program to expand, to launch investigations into the parent waters of the California Current, to probe into the deeper waters underlying this area, and to greatly enlarge the repertoire of tools and instruments available for the investigations. In addition, associated programs within the La Jolla complex have developed and have greatly expanded and diversified the inquiries into the eastern North Pacific.

There is a special pertinency in this expansion of investigation into this great oceanic region. As the world's pulse quickens to the increasing exigencies of the problems that beset mankind, there is increasing international awareness of the potential of the oceans to meet human needs. There also is an increasing realization of the challenge that the ocean presents to the human intellect. Thus the years of continuing surveys, studies, analyses, and of advancing insight into this

“best understood region of the world's oceans” constitute an immensely valuable base from which to expand new inquiries and to launch new probes.

The following briefly discusses this continuing program and the new directions of investigation, points up some of the important findings, and outlines the directions of future research. Some detailed results are published within these reports and others are published elsewhere, as listed in the publications.

Monthly surveys were conducted for the first ten years of the investigations. In some months these covered the entire CalCOFI area. Since 1961 the principal surveys have been carried out quarterly and with increased range, particularly seaward. These surveys have thus documented the near-surface circulation, chemistry and organisms over more than a decade.

The early period of the CalCOFI observations was characterized by surface waters of a slightly lower temperature (especially in spring) than the long-term mean. Much warmer conditions obtained in the latter part of 1957, in 1958, and in part of 1959. This change was the subject of an issue of the Reports (VII). Since 1959 and through the first part of 1963, the surface temperatures have been more nearly normal, that is, instead of the huge areas of above- or below-normal

temperatures that had characterized the warm and cool years, there were many small areas of above- or below-normal temperatures spread irregularly over the region.

The explanation for the variations of surface temperature apparently lies in the behavior of the winds over the North Pacific. During the early period the winds from the north were somewhat stronger than the long-term mean, but in 1957 and 1958 they were weaker than the mean. Since 1959 the winds have varied rapidly and irregularly, and no long periods of strong or weak winds have occurred.

During the persistent "cold" years the zooplankton increased in general abundance and assumed a more northern character. The jelly-like salp dominated the zooplankton in some of these years. In the warm years, there was an influx of more southerly organisms and the proportion of salps greatly decreased. The total volume of zooplankton was reduced but was richer in crustacea and other more substantial organisms.

As discussed in Volume IX of the reports, a policy has been adopted to intensify study of past data and to employ ship time for the investigation of special features and to test hypotheses. The quantity and distribution of many major species from all important groups of zooplankters continues to be studied and reported. The dominant groups of zooplankton, the copepods, has been the subject of special study and an atlas of species distribution is in advanced preparation. A special cruise supported by the Atomic Energy Commission will enable us to explore the distribution of water properties and organisms in the deep water under the California Current.

The Biomass Analysis Laboratory has been organized and work commenced on the analysis of zooplankton from the standpoint of their organic content. Plans for this were discussed in Volume IX of the **Reports**. The zooplankton are now being measured in a way as measures their effect on the environment as food, grazers, predators and associates in the pelagic milieu. The zooplankton are divided into some twenty-one groups, and by size, and the volumes of the divisions are measured. From these results should emerge an enhanced understanding of the quantity, nature and variation of this important component, and we should be able to evaluate the importance of transport of this organized food into the California Current system.

Understanding of the basic phytoplankton productivity will be greatly advanced by the organization of a new research group fostered by the Institute of Marine Resources and established on the San Diego Campus. This group will carry on productivity and food-chain studies. The Marine Life Research Program will closely cooperate with these investigators in ship operations and has transferred its micro-nutrient work into this new activity.

In like manner a future marine physiological laboratory on the San Diego Campus will greatly enrich the general program in the future.

A new and highly promising line of investigation has been undertaken in the last year. This is an historical study of the California Current system. The in-

vestigation has the purpose of reconstructing, as far as is possible, the oceanographic, meteorological and biological history of this region. There are, of course, many reasons to do this. The fifteen years of investigations have revealed some years of sharply differing oceanographic conditions. The nature of the climatic changes and watermasses involved are now sufficiently well understood that unusual observations in the past can now probably be interpreted sufficiently to enlarge our understanding of the long-term conditions and changes.

The historical investigations will be based on two different sources. First, written records of early explorers, survey parties, whalers, galleons, etc. will be studied for the conditions that they reveal. Specific years with unusual events will be particularly sought. There is much to be learned from these records. It is known that rather profound climate changes have occurred, with unusual storms, tropical fish and other remarkable events influencing the coast at least as far north as Central California, in some years.

Intimately tied with this documentary study will be a detailed study of the unusual stratified sediments of the Santa Barbara Basin. These unusual sediments, described by Emery, constitute a "memory" that the ocean possesses of the water masses and creatures that have influenced the coast in the past. To some degree these sediments also record climate changes, such as years of unusual rainfall. They also may tell us something about the variations in the past abundance of fish!

These sediments are apparently deposited very rapidly ( $\sim 1$  mm per year), and the skeletons of the microorganisms from the various water masses have settled to the bottom here and have been preserved. River sediment also is deposited and an early inspection of one core shows many easily identifiable marine fish scales preserved in these annual layers (see photograph). Following an analysis of cores from the Santa Barbara Basin it will be particularly important to find other sediments of this type elsewhere along the coast so that the study can be broadened.

It is not impossible therefore that in the next few years we may be able to develop tools that will tell us much about the variations in climate, in circulation, and in the relative abundance of various fish in this part of the California Current for the last thousand years or so and with almost a year-to-year resolution.

Particularly important will be the relative abundance of different species over the period and the manner in which changes in their abundances are related to the changing water masses.

During this last year considerable progress has also been made in the understanding of the studies of day-caught and night-caught larvae of the Pacific sardine and northern anchovy. This is extensively reported in this volume. From these studies a measure of growth and mortality of sardine larvae is derived that is quite consistent with the spawning success as measured by catch statistics. From this study it may be possible to understand the spawning success

of a pelagic species in the year of spawning rather than by awaiting data collected in later years. The larvae caught in the day are apparently not dead or dying as previously thought, but are a special category of larvae that represent the proportion of the larval population that is being removed by mortality. They are alive and growing. They may be merely less alert, weaker or singly distributed (i.e. unschooled) and hence more readily caught both by the net and by their predators.

Other important indications emerge from this study. The sardine larvae is apparently more successful where they cohabit with the anchovy than where they are separate. This merely argues that both seek similar "good" conditions. Also, the *mass* of sardine larvae and anchovy larvae appears to increase at a constant rate with age. This argues that the larvae are limited by a fixed rate of food input. Development of instruments has continued during this period. Progress has been made in solving the problems of deep-moored instrument platforms. One mooring in 600 fathoms off La Jolla has now been in for more than one year. Other tests have shown that the weaknesses are being corrected. The record-

ing system is successful and within the next year there will be extensive tests far off shore. It appears that the goal of developing stations that can be moored in 3000 fathoms, that will take hourly observation down to several hundred meters, and that will survive for six months in the open sea can now be realized.

Several new collecting devices have also been developed for better sampling. This includes an all-plankton netting 10-foot midwater trawl, a new opening and closing net for tandem towing and a current meter that will record currents down to 3000 fathoms for 4 weeks.

This concert of new tools now makes it possible better to explore such regions as the abyssal waters and creatures underlying the offshore portions of the California Current and the great faunal boundaries of the eastern North Pacific where the types of creatures change abruptly.

A special cruise through the North Pacific Current is therefore planned for the coming year to explore the profound boundary between this parent current and the Central Pacific water mass.

## REVIEW OF THE PELAGIC WET FISHERIES DURING THE 1961-62 AND 1962-63 SEASONS<sup>1</sup>

### SARDINE

#### 1961-62 Season

The 1961-62 season started with a "bang"; 1,660 tons were caught by 35 boats in southern California during the first night (September 4). The bright prospects soon faded, limits were abandoned, and the season's landings of 25,528 tons failed to equal those of the relatively poor preceding year (Table 1). The small catch was not surprising to CalCOFI scientists since it exceeded their pre-season estimate by only about 20 percent.

The season officially began August 1 in central California and September 1 in southern California, and continued through March 1 in both areas. This was two months longer than recent seasons. In addition, beginning June 1, 1961, a special summer sardine pack was legalized for the first time since 1948. Sardine prices were set at \$50 per ton, an increase of \$15 above the previous season.

Fishing off central California was poor, and accounted for only 2,231 tons of the total landings. Catches were made in Monterey Bay and along the coast as far south as Morro Bay. Southern area catches were made at Anacapa Island, Port Hueneme, Santa Barbara Island, Santa Catalina Island, Tanner and Cortez Banks and scattered locations along the mainland from Point Dume to La Jolla.

Fish sampled at San Pedro had a modal body length of 226 to 228 mm (mean, 224 mm) and an average weight of 0.31 pounds compared to the 0.27-pound average during the 1960-61 season. There had been very little recruitment. Age composition of the southern California catch was: 20 percent three-year-olds, 48 percent four-year-olds, 26 percent five-year-olds, and the remainder (6 percent) were two- and six-year-olds. In central California: 42 percent were 4's, 44 percent 5's, and the remainder (14 percent) two-, three-, and six-year-olds.

"And then there was one..." During the heyday of the sardine fishery, Monterey was called, "The Sardine Capital of the World." "Cannery Row" included 18 plants and was supplied by 78 purse seiners. As the fishery declined, the number of plants decreased until by the beginning of the 1961-62 season only five remained active. This number was reduced to three in December 1961, two in April 1962, and finally one in July 1962. "Cannery Row" is no more.

During 1961-62, the California sardine fleet consisted of 94 boats, 14 fewer than during the 1960-61 season: 51 were large purse seiners (60 feet and

over), and 43 were small purse seine and lampara boats (less than 60 feet). This included 19 boats which fished off central California only; the rest fished primarily south of Point Arguello, off southern California.

Baja California sardine landings totaled 21,270 tons for the season, only slightly less than the California total and slightly more than Baja California landings during 1960-61. The bulk of these landings were made at the six canneries operating in Ensenada (10,770 tons). The rest were landed at Cedros Island (8,527 tons) and Matancitas (1,972 tons).

#### 1962-63 Season

Although the sardine season officially began August 1, in central California and September 1 in southern California it never quite got off the ground. With the price of sardines set at \$50 per ton, the southern California fleet remained tied up. The price dispute was finally resolved in early October at \$60 per ton, \$10 above the preceding season. Mixed fish (less than 50 percent mackerel) sold for \$47.50. The fishermen went to sea under the new price structure, but the worst expectations of CalCOFI scientists came true. They predicted, in August 1962, that the 1962-63 season catch would range between 5,000 and 15,000 tons; only 4,172 tons were landed. Thus, the worst season since 1912 was written into the records.

Most central California sardines were taken south of Monterey Bay, between Point Sur and Morro Bay. Southern California sardines were taken from points along the coast ranging from Santa Cruz Island and Port Hueneme to La Jolla, and from the offshore islands and banks. Cortez and Tanner Banks remained important origins of fish.

Central California sardines had body lengths ranging from 154 to 266 mm, with a mode at 242 to 244 mm. Southern California sardines included both medium-sized and large fish, with a range of 188-266 mm, and modes at 202 and (the majority) at 234 mm. The average size was 228 mm, and the average weight 0.35 pounds. The modal size 20 years ago was around 200 mm, as was the average; the modal weight at that time was 0.2 pounds.

Ages were determined for 124 fish from central California, and 33 percent were four-year-olds, while 32 percent were five. Of 217 southern California fish, 34 percent were three-year-olds, 37 percent were four, and 28 percent five.

As in recent seasons in southern California, when large fish were present, some females contained developing eggs. During 1962-63, almost all of the females in 13 of 22 samples contained developing eggs, as did a few females in other samples. A sample taken October 23, a few miles off San Pedro, contained six

<sup>1</sup> For a report of catches for seasons preceding 1959-60, see *California Cooperative Oceanic Fisheries Investigations, Reports*, 8 January, 1961.



females, 234-246 mm body length, with ripe eggs, clear in color, in a running condition. This was unusual for that time of year. In October 1961, four such females were taken at Anacapa Island.

The fleet consisted of 81 boats; 45 large and 36 small. Of these, 9 lampara boats fished at Monterey only, most of the rest fished off southern California only.

Baja California landings (16,000 tons), although somewhat less than the previous three years, were nearly four times the amount landed in California. Unlike the previous season, Matancitas was the leading port with 8,020 tons. Landings at Cedros Island (4,674 tons) were considerably below preceding years.

**ANCHOVY**

Cannery and fresh-fish market landings continued at a low level through 1961 (3,856 tons) and 1962 (1,382 tons) despite a large population of anchovies (Table 2). These low catches reflected market conditions rather than a shortage of anchovies. As in recent years, most of the landings were made off southern California.

Live bait continued to dominate the anchovy catch, accounting for 59 percent (5,431 tons) of the total landings in 1961 and 82 percent (6,167 tons) in 1962. Approximately 80 percent of the catches in both years were made off southern California, between San Diego and Santa Monica.

The age composition of the bait catch at Port Hueneme during 1961 and 1962, was significantly different from the catch composition at Newport and San Pedro. At Port Hueneme, one- and two-year-olds dominated the catch in 1961 (55 and 37 percent, respectively) and in 1962 (62 and 23 percent). At Newport, the catch in both years was almost equally divided between zero-; one-; and two-year fish (27, 34, and 29 percent, respectively in 1961, and 35, 24, and 27 percent in 1962). Two-year-olds dominated the 1961 San Pedro landings (34 percent of the catch) with the remainder almost equally divided between zero-, one-, and three-year-olds (22, 24, and 18 percent, respectively). Bait samples were not obtained at San Pedro during 1962.

**MACKEREL**

The 76,857 tons of mackerel caught during the 1961-62 season, and 71,049 tons caught during 1962-63 represent the two best consecutive seasons on record (Table 3). These high landings were made possible by near-record catches of jack mackerel, exceeded in only three previous years, and substantial landings of Pacific mackerel, exceeded only twice in the last decade.

Mackerel prices to the fishermen were fairly stable at \$42.50 per ton during the 1961-62 and 1962-63 seasons. Lack of orders and "tie-ups" due to price disputes tended to reduce the total catch.

Central California catches were made in the Morro Bay area, off Point Sur, and in Monterey Bay. Prime southern California fishing areas were

around Santa Monica Bay, off San Pedro, between Newport and San Clemente City, and offshore at San Nicolas Island, San Clemente Island, and especially Cortez and Tanner Banks. *James D. Messersmith. California Dept. of Fish and Game.*

**TABLE 1**  
**SARDINE CATCH IN TONS ALONG THE PACIFIC COAST—1959-60 THROUGH 1962-63**

(Each Season Includes June Through the Following May)

Season	Northern California*	Southern California	Total California	Baja California	GRAND TOTAL
1959-60	16,109	21,147	37,256	21,446	58,702
1960-61	2,340	26,538	28,878	19,899	48,777
1961-62	2,231	23,297	25,528	21,270	46,798
1962-63†	1,211	2,961	4,172	14,620	18,793

\* All northern California landings were made north of Pt. Arguello.  
† Preliminary.

**TABLE 2**  
**COMMERCIAL LANDINGS AND LIVE-BAIT CATCH OF ANCHOVIES IN TONS IN CALIFORNIA, 1959-1963**

Year	Commercial Landings	Live Bait	Total	Percent Live Bait
1959	3,587	4,737	8,324	56.9
1960	2,529	4,657	7,186	64.8
1961	3,856	5,431	9,287	58.5
1962	1,382	6,167	7,549	81.7
1963*	2,285	6,930	9,215	75.2

\* Preliminary.

**TABLE 3**  
**CALIFORNIA SEASONAL CATCH IN TONS OF PACIFIC AND JACK MACKEREL**

(Each Season Includes May Through the Following April)

Season	Pacific Mackerel	Jack Mackerel	Total	Percentage Pacific Mackerel
1959-60	20,641	33,280	53,921	38.3
1960-61	19,537	25,286	44,823	43.6
1961-62	22,150	54,707	76,857	28.8
1962-63*	22,627	48,422	71,049	31.8

\* Preliminary.

**TABLE 4**  
**ANNUAL COMMERCIAL LANDINGS IN TONS OF PELAGIC WET FISHES IN CALIFORNIA, 1959 THROUGH 1963**

Year	Sardines	Anchovies	Pacific Mackerel	Jack Mackerel	Herring	Squid	Total
1959	37,184	3,587	18,801	18,754	864	9,826	89,016
1960	28,766	2,529	18,404	37,473	900	1,281	89,353
1961	21,585	3,856	22,055	48,803	701	5,143	102,143
1962	7,681	1,382	24,289	44,989	653	4,684	83,678
1963*	3,564	2,285	20,121	47,721	315	5,780	79,788

\* Preliminary.

## PUBLICATIONS

1 July 1962–30 June 1963

- Ahlstrom, Elbert H. and J. R. Thrailkill. 1962. Abstract of "Plankton volume loss with time of preservation." *Rapp. et Proc. Cons. Internat. Explor. de la Mer.* Vol. 153, p. 78.
- Ahlstrom, Elbert H. 1962. Fluctuations and fishing. Methodological paper no. 5, Proceedings World Scientific Meeting on the Biology of Sardines and Related Species, Food and Agriculture Organization of the United Nations, Vol. III, P. 1353–1371.
- Ahlstrom, Elbert H. 1962. Review of "Fauna e flora del Golfo di Napoli. Monografia 38: Uova, larve e stadi giovanili di teleostei." *Copeia*, No. 4, p. 858–860.
- Ahlstrom, Elbert H. 1962. Synopsis on the biology of the Pacific sardine (*Sardinops caerulea*). Species synopsis no. 12, Proceedings World Scientific Meeting on the Biology of Sardines and Related Species, Food and Agriculture Organization of the United Nations, Vol. II, p. 415–451.
- Berner, Leo, Jr., Robert Bieri, Edward D. Goldberg, DeCoursey Martin and Robert L. Wisner. 1962. Field studies of uptake of fission products by marine organisms. *Limnology and Oceanography*, suppl. 7: lxxxii-xci.
- Berry, F. H. and I. Barrett. 1963. Gillraker analysis and speciation in the thread herring genus *Opisthonema*. Inter-American Tropical Tuna Commission Bulletin, Vol. VII, No. 2, p. 111–190.
- Boyd, Carl M. and Martin W. Johnson. Variations in the larval stages of a decapod crustacean, *Pleuroncodes planipes* Stimpson (Galatheidae). *Biological Bulletin*, 124 (3): 141–152.
- Brinton, Edward, 1962. The distribution of Pacific euphausiids. *Scripps Inst. of Oceanography of the Univ. of Calif., San Diego, Bulletin* 8(2): 51–270.
- Brinton, Edward, 1962. Two new species of euphausiacea, *Euphausia nana* and *Stylocheiron robustum* from the Pacific. *Crustaceana*, 4(3): 167–179.
- Brinton, Edward, 1962. Variable factors affecting the apparent range and estimated concentration of Euphausiids in the North Pacific. *Pacific Science*, 16 (4): 374–408.
- Fager, Edward W. and John A. McGowan. 1963. Zooplankton species groups in the North Pacific. *Science*, 140 (3566): 453–460.
- Farris, David A. 1963. Reproductive periodicity in the sardine (*Sardinops caerulea*) and the jack mackerel (*Trachurus symmetricus*) on the Pacific coast of North America. *Copeia*, No. 1, 1963, p. 182–184. (Ichthyological Notes).
- Farris, David A. 1963. Shrinkage of sardine (*Sardinops caerulea*) larvae upon preservation in buffered formalin. *Copeia*, No 1, p. 185–186. (Ichthyological Notes).
- Gates, D. E. and R. S. Wolf. 1962. Age and length composition of the sardine catch off the Pacific coast of the United States and Mexico in 1959–60. *Calif. Fish and Game*, Vol. 48, No. 4, p. 232–242.
- Hyatt, H., 1961. The southern California mackerel fishery and age composition of the Pacific mackerel catch for the 1958–59 season. *Calif. Fish and Game*, 48 (4): 222–227.
- Isaacs, John D., 1963. Deep-sea anchoring and mooring. In *The Sea*, edited by M. N. Hill, New York, Inter Science, 1962–63, 2: 516–527.
- Isaacs, John D., James L. Faughn, George B. Schick and Marston C. Sargent, 1963. Deep-sea moorings; design and use with unmanned instrument stations. *Scripps Inst. of Oceanography of the Univ. of Calif., San Diego, Bulletin*, 8, (3): 271–312.
- Isaacs, John D., 1962. Note on an association of cumulus clouds and turbid water. *Jour. of Geophysical Res.*, 67 (5): 2076–2077.
- Johnson, Martin W. and Edward Brinton, 1963. Biological species, water-masses and current. In *The Sea*, edited by M. N. Hill, New York, Inter Science, 1962–63, 2: 381–414.
- Johnson, Martin W., 1963. Zooplankton collections from the high Polar Basin with special reference to the copepoda. *Limnology and Oceanography*, 8 (1): 89–102.
- Lasker, Reuben. 1962. Efficiency and rate of yolk utilization by developing embryos and larvae of the Pacific sardine. *Journ. Fish. Res. Bd. Canada*, Vol. 19, No. 5, p. 867–875.
- McGowan, John A., 1963. Geographical variation in *Limacina helicina* in the North Pacific. In *Speciation in the Sea*. Systematics Association Pub. No. 5: 109–128.
- O'Connell, C. P. and R. J. H. Leong. 1963. A toed plankton pump and shipboard filtering system for sampling small zooplankters. U.S. Fish and Wildlife Service, Special Scientific Report—Fisheries No. 452, 19 p.
- Orton, Grace L., 1962. Corrected list of published vertebral counts for certain eels (Apodes). *Copeia*, (3): 664–665.
- Orton, Grace L., 1962. Fish eggs and larvae in the plankton samples. *Limnology and Oceanography*, Suppl. to V. 7: xxxii–xxxviii.
- Orton, Grace L., 1963. Notes on larval anatomy of fishes of the order *Lyomeri*. *Copeia*, (1): 6–15.
- Perkins, H. C., 1963. "Redescription and second known record of the bothid fish, *Monolene asaedai*." *Copeia*, No. 2, p. 292–295.
- Reid, Joseph L., Jr., 1962. Distribution of dissolved oxygen in the summer thermocline. *Jour. of Marine Res.*, 20 (2): 138–148.
- Reid, Joseph L., Jr., 1962. Measurements of the California countercurrent at a depth of 250 meters. *Jour. of Marine Res.*, 20 (2): 134–137.
- Reid, Joseph L., Jr., 1962. Observations of inertial rotation and internal waves. *Deep-Sea Res.*, 9: 283–289.
- Reid, Joseph L., Jr., 1962. On circulation, phosphate-phosphorus content, and zooplankton volumes in the upper part of the Pacific Ocean. *Limnology and Oceanography*, 7 (3): 287–306.
- Ripley, W. E., K. W. Cox and J. L. Baxter, 1962. California sea lion census for 1958, 1960 and 1961. *Calif. Fish and Game*, 48 (4): 228–231.
- Roden, Gunnar I., 1963. On sea level, temperature, and salinity variation in the central tropical Pacific and on Pacific Ocean islands. *Jour. of Geophysical Res.*, 68 (2): 455–472.
- Taylor, C. C. 1962. Growth equations with metabolic parameters, *Journ. du Cons.*, Vol. XXVII, No. 3, p. 270–286.
- Thrailkill, J. R., 1963. Zooplankton volumes off the Pacific coast, 1959. U.S. Fish and Wildlife Service, Special Scientific Report—Fisheries No. 414, 77 p.
- Wisner, Robert L., 1962. Midwater trawl surveys. *Limnology and Oceanography*, suppl. to V. 7: xxxix-xli.
- Wisner, Robert L., 1963. A new genus and species of myctophid fish from the south-central Pacific Ocean, with notes on related genera and the designation of a new tribe, *Electronini*. *Copeia*, (1): 24–28.
- Wisner, Robert L., 1963. *Lampanyctus lubbi*, a new myctophid fish from the east-central tropical Pacific Ocean, with notes on the related, sympatric eastern Pacific species, *L. omostigma* and *L. parvicauda*. *Copeia*, (1): 16–23.
- Wooster, Warren S. and Joseph L. Reid, Jr., 1963. Eastern boundary currents. In *The Sea*, edited by M. N. Hill, New York, Inter Science, 1962–63, 2: 253–280.

**PART II**  
**SCIENTIFIC CONTRIBUTIONS**

## SYMPOSIUM ON LARVAL FISH BIOLOGY

### PREFACE

The extreme fecundity of many fishes belies the fact that rarely do more than one or two survive among thousands of spawned eggs. Mortality, and its corollary survival, is largely determined among fishes in those early stages known as eggs and larvae. Although information has been accumulating on this subject for over fifty years there has recently been an upsurge of interest in the biology of fish larval stages beyond the taxonomic field. Scientists have come to realize that with knowledge of the distribution of fish eggs and larvae the spawning range can be delimited and that a census of the eggs and larvae in an area can be used to estimate the size of the spawning population. Knowing the diminishing numbers of older larvae allows an assessment of mortality, the number of survivors, and the size of the succeeding year classes. Information on larval food and physiological requirements now permits an intelligent approach to rearing fishes. Ultimately we hope to be able to predict what the effect of the environment is on spawning success.

It is little wonder then that biologists and others concerned with fisheries are finding that an under-

standing of the fluctuations of fish populations depends in large measure on what we know about fish larval stages. This is particularly true of the California Cooperative Fisheries Investigations (CalCOFI) which has the problem of explaining the many fold variations in spawning success of the Pacific sardine. It was therefore timely that this symposium on Larval Fish Biology should form the heart of the CalCOFI Conference held at Lake Arrowhead in October 29 through 31, 1963. In organizing this symposium I intended that it have as broad a base as possible; thus it ranges from the study of fish larvae in fresh water to those in sea water, and from the technology of fish rearing to the basic physiology of single eggs and larvae. I hope this volume will prove useful to those interested in the study, conservation, management and exploitation of the world's fish resources.

We are indebted to the United States Department of the Interior, Bureau of Commercial Fisheries, for providing the travel funds for our foreign participants.

REUBEN LASKER, Editor

# ON THE IMPORTANCE OF LARVAL SURVIVAL FOR THE POPULATION DYNAMICS OF MARINE FOOD FISH

GOTTHILF HEMPEL

Institut für Hydrobiologie und Fischereiwissenschaft der Universität Hamburg, Germany

## I. INTRODUCTION

Looking back at the first century of fisheries biology we see that each generation puts emphasis on a different aspect of the changes in abundance of exploited fish populations. The earliest publications stressed the point that fishing will reduce the spawning potential of a stock, and that this will lead to insufficient recruitment. The establishment of fish hatcheries to replenish the marine populations was the logical answer to these worries. Later, the influence of fishing on the composition of adult stocks in size and age was emphasized. Regulatory measures aimed at better yields were introduced. The influence of composition and density of the stock on the individual growth was discussed and models of the population dynamics of marine fish were developed. After the first "wave" of considerations of fishing effort versus yield, the detection of the fluctuation in year class strength and of changes in distribution forced the biologist to recognize fish stocks as ecological units dependent on changing environment rather than as a simple group of specimens which could be managed by man as he liked. At the present time, the biologists who stress mainly the effect of fishing and the other more fatalistic group who hold great stock in the idea of the overwhelming effect of the environment must face together the problem of recruitment. It is the common opinion of both groups that recruitment is one of the main factors determining the size of a heavily exploited fish population. During the last few years, the importance of recruitment to the exploitable stock gained world-wide interest, especially in those fisheries which are only based on one or two age-groups, mainly recruits.

The recruitment problem is now tackled from several angles. As in the old days, schemes of rearing of marine fish on a commercial scale have been set up with a new emphasis on improving the techniques in rearing, holding and feeding of fry (see Shelbourne in this volume). Theoretical contributions to the interrelationships between spawning stock and resultant recruits have been published (e.g., Ricker, 1954; Beverton and Holt, 1957; Murphy, 1961; Beverton, 1962). The distribution of fish larvae in the sea has been investigated for a very long time, but until now, data on the survival of larvae in the sea is scarce; some figures are, however, available on mackerel (Sette, 1942), Pacific sardine (Ahlstrom, 1954), smelt in the Elbe estuary (Lillelund, 1961), and Pacific herring (Stevenson, 1962). Extensive studies on larval plaice and herring are now under

way in British, Dutch and German laboratories. The need for simultaneous physiological work on marine fish larvae was realized eighty years ago (Meyer, 1878). Hempel and Blaxter (1963) described a program combining experimental rearing and an investigation of the distribution and survival of herring larvae in the sea in relation to changes in the environmental conditions from year to year and place to place.

My basic concept, in the framework of which I will examine the available evidence, is that in the course of its life a fish belongs successively to three or more populations; the larval populations, the population of young and adolescent fish, and the population of adults. Each of these phases has its own dynamics. Nevertheless, each depends on the survival in the foregoing phase. Theoretically there has to be also an influence of the terminal phase, the spawning stock on the initial phase of the next cycle, the number of eggs produced.

This paper will be mainly confined to the various approaches one might take to understand the interrelationship between survival of larvae and size of the adult stock. How greatly are the stocks of larval and juvenile fish dependent on the size of the parental stock?

## II. DO ADULTS INHIBIT RECRUITMENT?

The simplest relationship would be that the adult stock simply decides on the number of recruits which it will accept every year in accordance with the carrying capacity of the habitat. According to Herrington (1948, see Ricker, 1954) this holds for haddock on the Georges bank where the adult stock determined directly from its own size, how many recruits were to be let in. Heavy competition for food between the adults and the pre-recruits resulted in a compensatory mortality of the pre-recruits. Radovich (1962) assumed that in the Pacific sardine very dense populations of adult fish have an adverse effect on the survival of the offspring due to competition for food.

Food competition between the adult stock and the young stages cannot be considered a general principle. In many species the utilization of food by larvae and adults differs both in size and in species composition. Adults and larvae may also occupy different geographical areas. More similarity is often found between the older stages of young fish (pre-recruits) and the adults. Nevertheless, year-class strength at this stage has normally already been fixed and the competition between old and young fish cannot be used as an explanation of the fluctuations.

In contrast to the results with crowded populations in small units of fresh water, studies of marine stocks indicate that the adult population does not take advantage of the whole carrying capacity of the habitat. There appears to be no quota for the acceptance of recruits in normal years. In populations such as the Norwegian herring and the North Sea haddock, the weight of the stock can increase several fold from one year to the next if a strong year class enters the stock. Those strong year classes do not, however, normally affect the growth and natural mortality as much as should be expected, if food and space were scarce. In addition, it may happen that after a year or two, another strong year class enters the stock just when the previous strong year class reaches its maximum biomass.

In most years recruitment is not sufficient to fill up the total number of vacant niches available for the adult stock. In regard to the food-niches, calculations by Petersen (1915), Thorson (1958) and Hardy (1959) showed that flatfish in the Kattegat used only one to two percent of the weight of available food. Invertebrate predators, chiefly starfish, ate the rest. Therefore, we may conclude that more fish could live in this area. The success of transplantation experiments into underpopulated areas is another hint. There is no reason why those stocks should not let in far more recruits if they were available.

### III. SIZE AND COMPOSITION OF SPAWNING STOCK DETERMINES TOTAL EGG PRODUCTION

Another relationship is that the number of recruits directly depends on the number and weight of the female spawning stock. If the age and size-composition of the fish stock is constant, the number of eggs will fluctuate with the total biomass of the female stock. In the main species of marine food fish, we have no evidence that egg resorption or additional production of eggs occur to compensate for differences in the spawning potential.

As soon as the age composition of the stock changes, the spawning potential will be altered considerably. In most fish the number of eggs increases sharply with the body weight of the mother. As a modifying factor, age itself has a direct effect on the spawning potential of the fish, e.g., in Baltic herring, (Krivobok, 1961). A spawning population which consists mainly of young recruits will have a far lower total fecundity than a population of the same biomass but consisting of somewhat older fish.

### IV. IS THE NUMBER OF RECRUITS INDEPENDENT OF SPAWNING POTENTIAL?

The linear relationship between the spawning stock and the number of offspring disappears normally during the early life-history of the fish. At the time of recruitment, the number of young fish is no longer correlated with the size of the parental stock. One may refer only to some of the most recent discussions

of the subject by Gulland (1962), Beverton (1961) and Hempel (1963). There are two ways of testing this independence; either to trace the origin of especially rich or poor year classes, or to examine long term records on stock size and recruitment.

The enormous year classes of Norwegian herring in 1904, 1950, 1959, and 1960 were not the results of very large parental stocks. In the Pacific sardine, medium sized spawning stocks produced the strongest year classes (Radovich, 1962). Ricker (1954), using data from Tester and Stevenson, even showed that in *Clupea pallasii* off Vancouver Island the below-average spawning stocks produced the strongest year classes and stronger spawning stocks produced poor year classes. (Any conclusions about the relationship between recruitment and parental stock derived from long-term series of data may be limited by differences in availability and by bias in sampling, especially if there is a segregation by age groups within the adult stock.) Beverton (1961) published one of the best series of observations. It does not show any correlation for a ten-fold range of parental stock size in plaice. In those populations however where population size and/or fecundity are very low, a positive relationship must be expected.

Why does the positive relationship between the size of the parental stock and the number of offspring hold for the egg stage and then disappear during the subsequent stages of early life? Is the fact that the year class-strength of the recruits is statistically not correlated with the number of their parents due to a true independence or due to masking effects and the lack of long-time series? In the following both alternatives will be considered. Although no decision in favor of one of the alternatives can be provided, it is worthwhile to discuss their biological implications and look for new approaches toward various parts of the problem.

### IV. A. THE HYPOTHETICAL COMPENSATORY MORTALITY

A true independence between the number of recruits and the size of their parental stock may find its explanation in a compensatory mortality of the larvae or young fish; in other words, that the mortality rate following high egg production is more severe than that following low egg production. This explanation has been put forth several times, but proper proof is very difficult to achieve.

The compensation hypothesis envisages a "gate" somewhere in the early life history. It is narrow so as to permit passage of only a small number of fish toward the goal of recruitment. The width of this gate may change from year to year, and through this, the number of pre-recruits fluctuates. It may be assumed that the compensatory mortality works over a wide range of egg production. It will, however, fail to operate in very low stock-density, i.e., when the scarce stock of larvae does not occupy the entire carrying capacity of the habitat.

The compensation for high or low larval abundance may not be confined necessarily to a short specific

stage in the early life history, but the larvae and young fish may have to pass through several critical phases during which different density dependent factors level the annual abundance of recruits. In other words, it may happen that the corrections made by larval mortality are very crude, leaving the larval stock to vary within wide limits due to over- or under-compensation of primary larval abundance. After metamorphosis, further mortality with a density-dependent component may correct for those variations. Smelt (*Osmerus eperlanus*) in the mouth of the Elbe river showed indications of compensatory mortality after rather variable larval mortality (Lillelund, personal communication). In demersal fish, crowding at the first settling ground in coastal waters may have a regulatory effect. In pelagic fish, however, compensatory mechanisms of this kind are more difficult to imagine. Very little is known about the life history of most of our food fish in the phase between metamorphosis and the recruitment to the adult stock. Therefore, the considerations of this paper will be confined to the egg and larval phases only.

#### IV. A. 1. Are fertilization and egg mortality density-dependent?

In salmon and other species with an elaborate spawning behavior and special demands for spawning beds, high crowding on the spawning grounds disturbs spawning. No similar indications are at hand for the main marine food fishes. High percentages of unfertilized eggs are not reported. (It would be difficult, however, to trace this in species with pelagic eggs. Dead eggs sink rather quickly.) Rollefson (1931) discussed the optimum dilution of sperm for marine fish. Fertilization rate is low with very diluted dispersions of sperm but it remains constant at almost 100% over a wide range of sperm concentration. In species with demersal eggs, fertilization is not affected by multiple layering of the egg-masses. Most of the eggs seem to be fertilized just at the moment they sink to bottom.

In the open sea strong density dependent mortality of pelagic eggs is difficult to imagine. Even in very dense spawning, one will find only a few eggs per liter of surface water. The effect of dense shoals of cannibalistic, plankton-feeding parents (specially Clupeoids) has been mentioned several times (e.g., Radovich, 1962), but no proper data on their feeding intensity are available. Normally the daily mortality in the egg stage is rather low compared with the larval mortality. According to Sette (1942) the mackerel has a daily loss of 5% at the egg stage, but a loss of 10 to 14% of the larval stage. The intensity of egg production in species with demersal eggs may have a stronger influence on egg mortality than in species with floating eggs. In rearing experiments, herring eggs are very sensitive to dense compacting. In the sea, however, mortality is not very high in herring eggs, e.g., 12% in Norwegian waters (Runnstrøm, 1941) and up to 10% in British Columbian waters (Hart and Tester, 1934) where predation by birds plays a considerable role (Outram, 1958). For eggs deposited in littoral and uppermost sublittoral zones, also, desiccation

can be a significant detrimental factor (Hempel, unpubl.). Runnstrøm (1941) made a careful survey of the mortality of eggs deposited on rock or gravel. In contrast to Lea (1931), he found the sheets of spawn were rarely composed of more than 10 layers of eggs. The normal thickness was less than five layers. That is in agreement with the findings of Parrish, *et al.* (1959) on Clyde herring, where egg mortality was very low. In Norwegian egg-sheets, mortality increased during the incubation time, especially toward the end. It sometimes reached 97% in the lower egg-layers and 39% in the top layers. Neither Runnstrøm nor Parrish, *et al.* observed egg-sheets after hatching to check whether an additional mortality had occurred at about the time of hatching. According to Runnstrøm, high egg production by a large parental stock results in thicker layering rather than in extension of the spawning grounds. Runnstrøm stated, however, that there is little adverse effect of high egg production on the later recruitment, because even with high egg production, only very few of the sheets are detrimentally thick.

#### IV. A. 2. Is larval survival density-dependent?

Three main causes of mortality may be considered: (1) abiotic factors, (2) predation, and (3) starvation. I will discuss these factors first in relation to possible density-dependent effects.

(1) *Mortality from abiotic factors* has no compensations as long as the differences in the spawning potential do not create changes in the distribution of eggs in space and time.

(2) *Predation* has been regarded as the main cause of mortality in the Pacific sardine, but Murphy (1961) stated that this mortality by predation is independent of larval production because larvae make up only a minor part of the food supply for the marine predators. In general this is true. The larval stage is short (usually only a few weeks) in most marine fish populations; therefore, the larval population will not give rise to a build-up of great populations of predators.

(3) *Starvation* may be discussed in its relation to competition within the group of larvae. The extent of starvation due to competition within a group of larvae depends on several factors:

- (a) number of larvae per unit volume of water.
- (b) number and size of suitable organisms present per unit volume of water within the range (geographical area and depth zone) where the larvae live.
- (c) patchiness of distribution of the plankton.
- (d) "natural" population dynamics of the food organisms (other than grazing by the larvae), i.e., other sources of mortality, reproductive rate, individual growth, immigration, emigration.
- (e) number of organisms eaten daily per larva.
- (f) volume of water searched per day. This depends on the number of hours per day in which light

is sufficient for perception of food organisms in a given depth, the distance that larvae swim per day, their distance of perception, and their catching ability.

- (g) dispersion and migration of larvae in relation to the movement of the plankton.

Essential to the sufficient feeding of the larvae is a high absolute abundance of food organisms. Larvae with poor swimming performance and a small field of vision will be able to search only a small amount of water, in some cases only a few liters per day. In this amount of water, the larva must meet a considerable number of food organisms of proper size. A young sardine larva requires a concentration of about 20 copepod nauplii per liter (Nishimura, 1958; for rate of feeding see Lasker in this volume). The larvae will catch some of these organisms, others will be missed.

The next item to consider is the concentration of the larvae themselves; are they so concentrated that a considerable overlap of the individual feeding spaces occurs? Do the larvae stay for so long in the same mass of water that they deplete the plankton markedly? If there are only a couple of sardine larvae per cubic meter, and if each larva searches 5 liters per day, the grazing effect and the competition are insignificant. Survival depends merely on the abundance of food (not on the density of the larval stock). In larvae with better vision and better swimming performance, the volume of water searched every day is far greater. This involves an increasing probability of an overlap between the individual feeding spaces of neighboring larvae, which may finally result in serious competition during a period of low abundance of food.

A careful evaluation of the competition in larvae requires a combination of field work and laboratory experiments. A program of this kind (Hempel and Blaxter, 1963) is now established for various stocks of North Sea herring and Clyde herring which spawn in different seasons. The herring larvae are caught by the Gulf III sampler, the plankton by the Hardy plankton-recorder using narrow-meshed discs aiming for quantitative sampling of the smallest food organisms. In addition to this work at sea, which also includes investigations in the diet, in changes of the behavior of larvae and of their habitat, experiments on the feeding and the food-demand of herring larvae are in progress (Blaxter in this volume).

#### IV. A. 3. Indirect effects of stock size on larval survival

The size of the spawning stock and especially its age-composition often influences the spatial distribution of spawning and the duration of spawning time. It is this indirect effect of stock size which may result in density-dependent differences in larval survival. Changes in the size of the spawning stock may be connected with changes in the age-distributions; a decreasing stock may show a lack of old fish. The bigger stock often has a wider range of sizes than the smaller one, especially if this small stock is mainly confined to recruit-spawners. Extension of the spawning ground during years of strong spawning and prolongation of

the spawning period, however, have quite different effects on different stocks. In herring off Newfoundland, it endangers the stock (Olsen, 1961) but in arctic cod it results in strong year classes (Wiborg, 1954). A change of temperature is often connected with those shifts. In herring of the western Baltic, the spawning season is very long, lasting from the beginning of March to the beginning of June. In this period, the water temperature may rise from 4°C to 18°C. The effect of this shift in temperature on the biology of the larvae is very complex. It affects incubation time, duration of yolk sac stage, rate of growth, rate of resorption of the body reserves, swimming speed, digestion rate, food demand, etc. It also affects the abundance and species-composition of food plankton and predator populations. In rearing experiments, Blaxter and Hempel (1961 and 1963) analyzed some of the effects. Of special importance for the survival rate might be duration of the pre-feeding phase, i.e., the time from spawning until the larvae are capable of active feeding. This phase lasts only 10 days at 15°C but 30 days (or more) at 5°C. The span of time the larvae can live without food from hatching until death by starvation is 10 days at 15°C and 21 days at 5°C. The time from hatching to the "point of no return", i.e., the phase in which non-fed larvae become too weak to start feeding is twice as long at 5°C than at 15°C. In the Baltic herring also, young fish spawn late in the season.

A rejuvenation of the stock will therefore delay the average peakdate of spawning toward a season of higher average temperature. This will affect the very sensitive early stages of larvae. Changes in time and place of spawning may also have an influence on the transport of larvae to areas which are suitable for feeding or setting. One of the main effects, however, will be a change in the coincidence of the larval phase and the period of high production of small zooplankton. Beverton (1961) suggests that late-hatched plaice larvae may reach their feeding stage at a time when their older brothers have taken most of the baby food, the young *Oikopleura*. The older larvae are big enough to switch over to bigger food organisms but the young larvae will die. This would be a typical compensatory mortality for a great stock of plaice spawning over an extended period.

In recent years, biologists have increasingly considered the effect of feeding condition and age of the spawners as an indirect effect of stock-size on the quality of eggs, and through this, an effect on the survival of the larvae and the extent of recruitment. This effect may take place through the age-structure of the population of breeding females and/or through the adequacy of nourishment of the females (which may be related to stock-density). This hypothesis requires careful experimentation. Nikolski (1961) refers to findings by Anokhina (1960) on White Sea herring which suggest that the fat content of the mother influences the variability in egg size, lean fish producing the wide range of egg-size which he considers favorable for survival of the biggest larvae. We could not detect this effect in North Sea herring.



Is there an effect of age and size of the mother on the survival of larvae? Eggs from Norwegian herring, partly from 4 to 5 year old recruits and partly from 10 to 14 year old fish, were reared separately under the same conditions. Eggs from the recruit-spawners were smaller than eggs from the older herring. After hatching, the larvae were starved. The larvae of the young mothers lived for 22 days, whereas the larvae from the older herring lived three days longer. This effect may considerably influence the survival rate of larvae in the sea; however, differences in spawning time of recruits and repeaters may counterbalance this. In those Norwegian herring the recruits spawn later during spring than the older herring. Thus, the larvae of these recruits hatch at higher temperatures and pass through the larval stage more rapidly. Also, the larvae of the recruits are smaller, and because of this, they are less capable of feeding; however, in spring these larvae will encounter more food than their brethren which were derived from older fish of the same race.

To summarize, there are indications of a proper density-dependent larval mortality (the "gate") only in special cases. *Direct* influences of stocksize on larval survival are very rare. *Indirect* effects due to shifts in spawning time and spawning season are probably more common.

## V. THE HYPOTHESIS THAT EARLY MORTALITY IS INDEPENDENT OF STOCK-SIZE

The second hypothesis assumes that there is a correlation between parental stock size and subsequent recruitment, although being normally not detectable in the relatively short periods of observation and being masked by natural fluctuations. If this hypothesis is correct, we have to assume that compensatory effects in mortality of the early stages do not exist or do not counterbalance sufficiently changes in parental stock size. Consequently the stock will not be stable in number (or fluctuate above and below an average) but will show a long-term upward or downward trend. As a consequence of selection the trend would be in most cases upward until the carrying capacity of the habitat for the adults is filled up or the larval population is not anymore only a minor element of the plankton community. A breakdown of the population can only be expected if the environmental conditions deteriorate faster than adaptation of reproduction (see below) can take place. A serious decline may also happen if the parental population is so heavily fished that the positive effect of adaptation is canceled out.

### V. A. PREDATION AND STARVATION AS NON-DENSITY-DEPENDENT PARAMETERS

Predation and starvation are the two main causes of larval mortality in many stocks of marine fish.

Their close relationship to the density of the larval stock was ruled out previously in this paper. We may assume that the rate of predatory mortality in a stock of fish larvae is mainly determined by the number of predators present, by their feeding capacity, and by

the ability of the larvae to avoid these predators. As long as the fish larvae comprise only a minor part of the total diet of the predators, the percentage of larvae which die by the predators will vary with the number of predators. In many cases, years of high predator abundance are also years of rich food abundance for the fish larvae and the food for larvae is often also the main food for the planktonic predators. For example, the early mass mortality in a population of larvae due to starvation might be relatively small in those years which have high predatory mortality. The inverse relationship between these two mortalities together with some compensatory mortality on later stages might be the reason why the fluctuations in year-class strength in some stocks of fish are far smaller than the fluctuations in the food organisms or the predators.

A factor not to be overlooked when considering starvation is the patchiness of food plankton and variations in the size and viability of the larvae which offers a chance of survival to at least a few larva, even if the "average" concentration of food and the searching effort of the "average" larva is far below the minimum level. Anokhina (1960) pointed to a higher variability in size of Baltic herring eggs in years of little food.

In a larval population suffering from early starvation, the survival curve will have the steep inflection typical of a "critical phase." If predation is the main cause of mortality, the curve might be more steady, with a constant or slowly decreasing instantaneous mortality. This mortality might bring the abundance of larvae down to the same low level as a "critical phase" caused by an abrupt starving period.

The adaptations of the larval production system which tend to alleviate mortality due to starvation are different than those which counteract predatory mortality. In order to meet deficiencies in food supply, the body of each larva should be equipped with a fair amount of energy reserve. Also, it should hatch at a stage of development where it will have a good swimming and feeding performance. If, however, predation is the main cause of mortality, the number of larvae should be as high as possible to keep the absolute number of larvae which survive on a sufficient level to ensure good recruitment. Because of the limit of reproduction in each female, both requirements conflict with each other. A compromise between size and number of eggs has to be achieved in order to cope with both kinds of mortality. It can be shown that this compromise is not uniform to all stocks of fish, but is closely related to the conditions larvae meet after hatching. An analysis of this phenomenon should be on an intraspecific level and based on very closely related stocks which differ mainly in spawning places and spawning season. The herring stocks of the northeastern Atlantic meet these requirements and offer a very good example.

### V. B. ADAPTATION OF REPRODUCTION IN HERRING

*Differences in egg size*—There is no part of the neritic region of the northern Atlantic and its adja-

cent seas which is not occupied by one or several stocks of herring (*Clupea harengus* L.). Each stock has its specific spawning area, its fixed pattern of migration, and its typical spawning season although stocks may intermingle and shift their spawning areas slightly. In the northeastern Atlantic, three main tribes of herring are described. Each of them is split into various local populations. The *Atlanto-Scandian* tribe, a large-sized herring with an ocean-wide range of migrations, mainly spawns in the late winter off Norway. Other spawning areas of somewhat minor importance for this tribe are off Iceland, Faroe Islands, Shetlands and along the edge of the North Sea and the British shelf. Off Iceland, an isolated group spawns also in summer. The tribe of the small *Baltic* herring consists of various populations mainly spawning in spring and summer. Related groups also spawn outside of the Baltic in northern Russian waters and in the coastal region of the North Sea. The true *North Sea* herring (medium body-size) is confined to the shelf areas only. Its spawning season is mainly in the second half of the year. Relatives of the North Sea herring with similar spawning behavior live in the waters west of England and Scotland. The area of distribution of the three tribes overlaps somewhat, however, the nature of their spawning grounds differs. The *Atlanto-Scandian* herring spawns mainly in rather deep oceanic water (40-200 m), the *Baltic* herring chooses shallower, often inshore waters in the littoral or upper sublittoral zone. It resembles the *Pacific* herring (*Clupea pallasii* Val.). The *North Sea* herring spawns on banks, mostly off-shore at depths of 20 to 40 meters.

Due to the differences in spawning season, the larvae of each stock will meet rather different environmental conditions. It seemed worthwhile, therefore, to check whether differences in number and size of eggs were correlated with seasonal differences in the environmental pressure of temperature, drift, and especially predation and shortage of food. Data on the number of eggs produced by females of the same size but of different geographical origin were gathered from the literature. They showed in general that autumn-spawning herring have a higher fecundity than spring-spawning herring. This finding had to be related to the average size of the ripe eggs (Hempel and Blaxter, in preparation). Samples of 50-200 herring in spawning condition were collected from each of the main spawning groups. In some cases it was possible to repeat the sampling over two to three years. The dry-weight of 100 ripe, transparent eggs per herring gives a good average measure of the nutritive value of a herring egg, although the relative weight of the egg-shell which is of no nutritive value for the larvae, decreases slowly with increasing egg size. For young mothers, egg-size increases with age. The differences between egg sizes of the first and the second spawning are especially great. At greater ages, the size of the eggs remains constant or it drops slowly (in very old fish). A comparison between fish of different stock parentage and different growth pattern should be based on fish at the second or third spawning. These would be 4-year-olds in *Baltic* herring, 5-year-olds in *North Sea*

herring and 7-year-olds in *Atlanto-Scandian* herring. These fish, however, differ in their body-length. In order to allow for a possible direct relationship of egg-size to size of the mother's body, herring of the same size regardless of their age in relation to first maturity have also been compared. For this, 27.5 cm was chosen as a reference length. (Fish of this size are first-time spawners in Norwegian herring, but second-to-third-time spawners, or even older, in *North Sea* and *Baltic* herring.) Both sets of values are given in Table 1. Obviously, *Baltic* herring have considerably

TABLE 1  
MEAN DRY WEIGHT OF RIPE EGGS IN DIFFERENT SPAWNING GROUPS OF HERRING

	recruit spawners			repeated spawners			mg at 27 cm total length
	age	mg	n	age	mg	n	
<b>Oceanic herring (Atlanto-Scandian) Norway</b>							
1961 + 1962-----	3-4	0.28	71	8-12+	0.35	128	0.26
Clyde 1962-----	2-4	0.32	54	(5-6	0.30	14)	0.32
<b>Shelf herring</b>							
Buchan 1961-----	3-4	0.16	15	5-7	0.16	33	0.15
Dogger 1961-----	3	0.26	54	5-10	0.28	18	(0.24)
Downs 1961-----	3	0.36	57	4-10	0.38	43	0.38
Dunmore 1962-----	2-3	0.31	13	4-10	0.36	43	0.38
<b>Coastal herring western Baltic</b>							
1961 + 1962-----	2	0.11	40	4-6	0.15	34	0.14

smaller eggs than Norwegian herring, although they do not differ greatly in spawning season (but rather in the living conditions for the fry, which find a very high abundance of food in the inshore waters of the *Baltic*). The difference between the two values for Norwegian herring results from the difference in age used in both sets. In *North Sea* herring, the mean weight of eggs varies considerably between spawning groups.

In the *North Sea* (Fig. 1) spawning occurs over a long period. The "autumn spawners" start in July at the Shetlands and continue in August-September off the Scottish coast. In September-October, they spawn in various places off the *North Sea* Coast of England and in the western part of the central *North Sea* (Doggerbank region). Some spawning of minor importance occurs at the same time, or a little later, at various locations further to the east. The southern group of *North Sea* herring (*Down-herring*) spawns in November-December in the entrance of the English Channel. It is uncertain whether the group of herring which spawn in January off the south coast of Ireland (*Dunmore herring*) is related to the *North Sea* herring.

Average values for complete samples, which cover the whole range of age-groups present in those populations (Fig. 2), emphasize that the summer-spawning *Buchan* herring have very low egg weights (0.1-0.2 mg dry matter per egg). These are similar to *Baltic* herring. In autumn-spawning herring of the *Dogger*

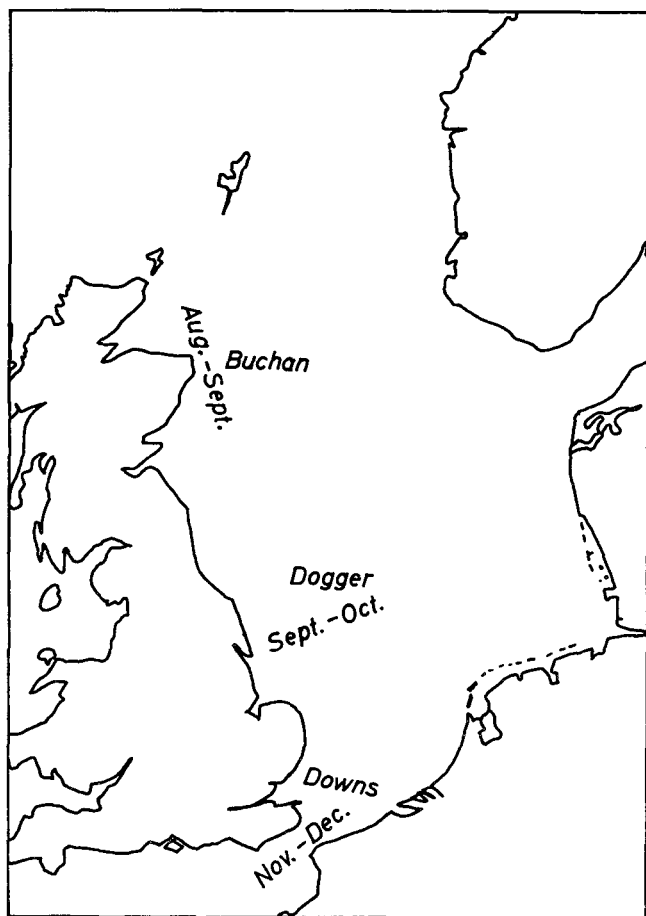

FIGURE 1. The main spawning communities of North Sea herring.

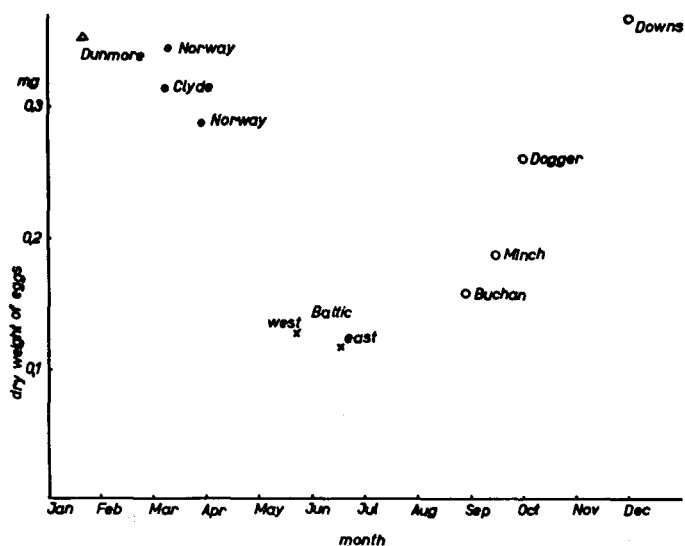

FIGURE 2. Mean dry weight of ripe herring eggs in relation to the spawning season. ● Atlanto-Scandian herring, x Baltic herring, ○ North Sea Shelf herring, △ Irish Shelf herring.

region, the mean weight of ripe eggs is significantly higher, and is higher still in Downs herring which spawn in early winter. In this southern group, egg-size (0.30–0.35 mg dry matter per egg) is about the same as in later winter-spawners off the coasts of Norway and western Scotland (Clyde).

Comparing fish of equal size, the individual energy-drain due to reproduction is of the same order in the different tribes of herring, although some minor differences are noteworthy. In Norwegian herring, the burden for reproduction is lower relative to body weight than in other groups of herring. This might be related to the greater longevity in this tribe than in other groups of herring. Within one tribe, the burden may vary in accordance with the spawning season (see below). The amount of organic matter put into the spawning products increases at a higher rate than the body-weight increases. Only in very old females does the weight of the gonad (calculated as the mean weight of the eggs times average number of eggs recorded in a female of a given length) seem to be reduced.

*The Ecological Value of Egg-Size*

The biological value of the size of the egg would be indicated best by percentage survival of the offspring in the sea. Measurement of this is difficult to achieve and the resultant data are open to some criticism.

In order to get some tentative indication of the quantitative relationship between rate of survival and egg-size we started rearing experiments. Eggs of different size and different origin were incubated under similar conditions (on glass plates in tanks or jars) mainly at 8° and at 12°C in 15‰ salinity, but with additional experiments at 5° and 14°C. and at different salinities varying from 5 to 50‰. After hatching, some of the larvae were sacrificed at various stages of development for measurements of the dry weight of larval body and yolk sac. Others were kept under constant conditions without food to see how long herring larvae developing from eggs of different size (and content of yolk) could survive on their body reserves. Fifty larvae of each female were transferred into jars with 1 to 2 liters of sea water. Every day the dead larvae were counted and removed. Normally, mortality started suddenly a few days after the resorption of the yolk sac. It was obvious that this mass mortality was due to starvation. Still other larvae were used for feeding and respiration experiments (Blaxter in this volume and Holliday, Blaxter and Lasker, 1964).

The results of the rearing experiments will be reviewed only briefly here (details in Blaxter and Hempel, 1963). Eggs of the following spawning groups were used: Norwegian herring, Clyde herring (west of Scotland), Kiel (western Baltic), North Sea herring from the Buchan, Dogger and Downs spawning grounds. For the different races, the average absorption of yolk was followed by daily (or every other day) weighing of samples of dried larvae. The mean weight of the unfertilized eggs of the mother used for the rearing experiments was known and

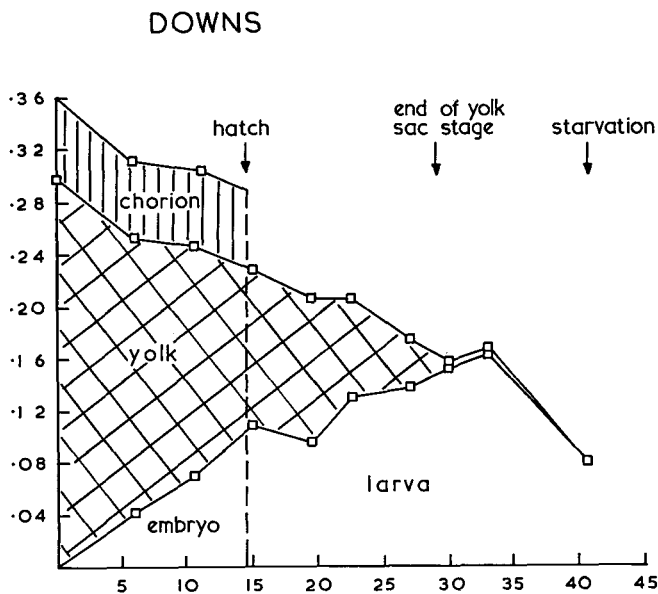
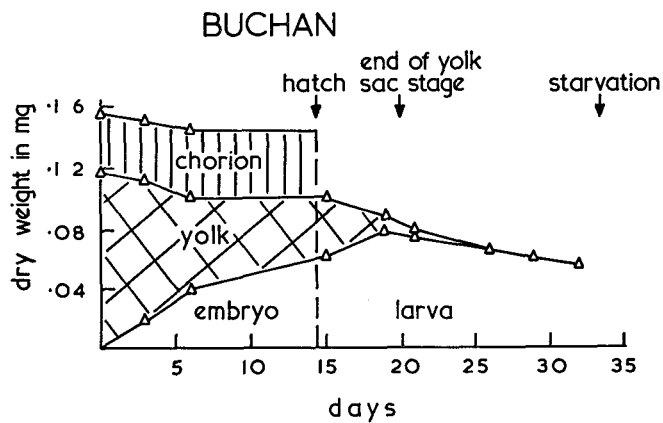

FIGURE 3. Changes in dry weight of chorion, yolk, embryo and larvae during the early development of herring.  
a) small eggs of a Buchanan summer spawner  
b) large eggs of a Downs winter spawner  
The larvae were not fed and died by starvation (from Blaxter and Hempel, 1963).

also the ratio between egg shell and yolk in the egg. The pattern of yolk utilization and the ratio between yolk sac and larval body at any given time depends on the egg-size. It was found, however, that larvae from eggs of the same size but from different races did not differ in these characters. Thus, we can consider Norwegian, Clyde and Downs larvae as a group of "big larvae," Buchan and Kiel larvae as "small larvae," whereas the larvae of Dogger-spawners belong to the group of the "medium-sized-larvae."

How do the "big larvae" compare with the "small larvae"? In Figure 3, typical examples for the progression of yolk-absorption are given for these two groups. In newly hatched Clyde larvae, dry weight of the yolk is far greater than the dry weight of the larval body although *incubation time* is the same as in small eggs. The larvae of the Kiel herring lack an

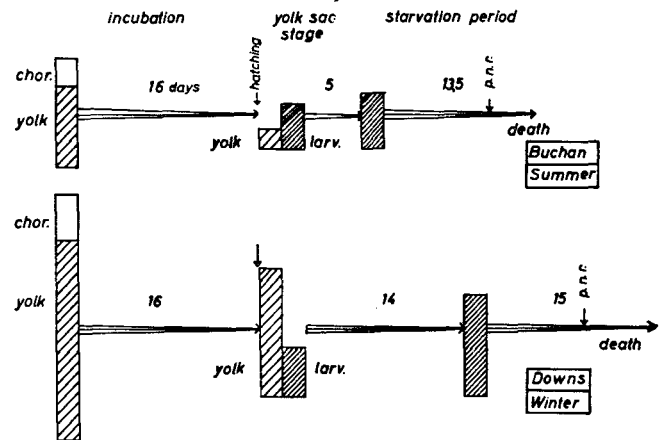

FIGURE 4. Different development of larvae of summer and winter spawners, due to difference in egg size. Development in days at 8°C. Larvae not fed. p.n.r. = point of no return. The vertical bars indicate the dry weight of a) yolk and chorion at fertilization, b) of yolk and larval body at hatching and c) of the larval body at the end of the yolk sac stage. The figures refer to the duration of incubation, yolk sac stage and starvation period (after resorption of the yolk).

appreciable yolk sac; most of the yolk content of the egg is used up in the course of incubation, partly for building the larval body and partly for respiration. In accordance with the size of the yolk sac, a considerable difference in the *duration of the yolk sac stage* has been recorded. While the yolk sac in Kiel larvae last only for three days, it remains for 10 to 14 days in Norwegian, Clyde and Downs larvae. Concerning the total "life span" of non-fed larvae we have to expect that larvae with great yolk reserves can endure starvation longer than can larvae with small yolk sacs. Under similar conditions, larvae of Norwegian herring lived 24 days after hatching while Kiel larvae survived for only 12 days. (Figure 4)

From the ecological point of view, the period of life up to the point when larvae become too weak to start feeding is of greater importance than the total "life span" which includes the final period of irreversible starvation between the "point-of-no-return" and the death. This point-of-no-return has been traced by Blaxter (this volume) in the course of feeding experiments at various stages of development. It is normally reached after the second third of the total life of unfed larvae.

Under the natural temperature conditions which both groups encounter in the sea, this difference will be even more striking. The average water temperature in the region where Norwegian herring spend their first month of life is about 6°C. Kiel larvae encounter up to 18°C. Kiel larvae reach the point-of-no-return about a week after hatching, whereas Norwegian herring will last for about three weeks. Among the habitats of the three groups of North Sea herring, water temperatures at spawning time are rather similar, ranging from 10–12°C, but it cools off in the southern region in mid-winter during the early larval stage of the Downs herring.

Differences in egg size also influence *length* and *breadth* of larvae at hatching. When leaving the egg shell, larvae hatched from big eggs are longer and broader than those from small eggs. The average length of larvae of Norwegian, Clyde and Downs herring was 8mm at hatching and that of larvae from small Baltic and Buchan eggs was 6.5mm. Beyond this point, the difference increased considerably due to the longer yolk sac period of the "big larvae". Norwegian larvae grew to a length of 11mm before the yolk was gone, while the larvae of small eggs reached only about 8mm body length by means of their yolk reserves. These differences in body size influence the size of the mouth aperture and the swimming speed of the larvae. At the stage when the larvae first become capable of feeding (during the second half of the yolk-sac stage), larvae hatched from big eggs may be able to take larger food organisms because they may swim faster and because they have wider mouth openings (details in Blaxter, in this volume).

The greater amount of yolk present in bigger eggs is used for two purposes: for a prolongation of the period that the larvae can last without food after hatching and also for increase in body size and hence, feeding performance. The relative contribution of the surplus yolk among these two purposes is similar in larvae of different tribes. Larvae of the Dogger herring, which has medium sized eggs, are in all characters intermediate between the larvae of big eggs and those of small eggs.

The importance of large size and greater feeding ability is probably greatest during winter when food is scarce, and especially when a sufficient supply of very small larvae of zooplankton is lacking. In winter there is a more restricted period of the day during which light intensity is sufficient for larvae to detect and snap up food. Light readings in the English Channel and the Straits of Dover in January showed that the maximum duration of daylight in the surface zone occupied by the larvae is 9 hours. At the spawning grounds of Sandettié, which is an area of high turbidity, the light intensity at the sea floor in thirty meters depth did not reach the threshold value for visibility of food at any time during an overcast winter day. Therefore, the area searched is rather small. This is balanced by more days of potential feeding before starvation, by a higher swimming speed, by better vision, by faster and more precise snapping and by the ability to swallow large organisms. The big eggs of winter-spawning herring provide their larvae with these advantages.

It may be bigger egg size alone which allows these populations to spawn in the most adverse season (from the standpoint of the feeding of the youngest larvae). The principle that under adverse conditions fish with low fecundity but well developed larvae have the best chance of survival seems to hold for all herring populations inspected thus far.

Winter is not an entirely adverse season for spawning. It has two advantages over summer: (1) Herring

can use the whole period from spring to autumn for feeding. That may be the reason why the individual gonad weight increases within the tribe of North Sea herring from 5g dry matter in summer spawning Buchan herring to over 6.1g in autumn spawning Dogger herring and to 7.3g in winter spawning Downs herring (among herring only of 27.5 cm total length). (2) The relatively low abundance of predatory plankton organisms in winter, whereas in the summer the larvae meet more predators. In many cases the larvae ascending to the surface must pass through a layer of medusae. In summer, high abundance of larvae seems most essential. Summer larvae, however, do not need highly developed feeding abilities because food organisms are abundant and the searching day is long. In the northern North Sea Buchan larvae which hatch in September find 14 hours of daylight. Kiel larvae have even a longer daily period in which they are able to see their food.

We have seen that herring can establish several distinct populations even in such narrow areas as the North Seas, the Irish Sea and the Baltic. These stocks living side by side differ mainly in their spawning time. This segregation was made possible only by adaptation of reproduction to the differential predation on and feeding by the larvae.

One might speculate on how the adaptation of reproduction to different conditions takes place. While effects of temperature and feeding conditions during the maturation of eggs may play a role, the main factor will, however, be selection. Slight differences in survival due to differences in the number-to-size ratio will have a considerable selective value. Through this, the optimal relationship will be achieved rather rapidly after a population has invaded a new area. Perhaps in herring, the number-to-size ratio of eggs is more variable than in other fishes and thus, the herring is in the position to occupy several different habitats.

If any increase in parental stock-size results in a wider range in spawning time and in spawning area, a portion of the larvae will find themselves under food/predator conditions for which they are not adapted. Before a new adaptation can take place, the stock will decrease due to higher initial mortality. This might be a mechanism by which an increase in population (which has been postulated to be a consequence of any form of positive relationship between spawning potential and recruitment) will be stopped.

In this paper I did not attempt to explain even tentatively why, in many stocks of marine fish, the number of recruits is the limiting factor for a steep increase in abundance and productivity. Experimental stocking and careful studies of the larvae and young fish in their natural environment might yield a better understanding of this question. One might guess that the answer would be along the line of a permanent sub-optimal adaptation of egg-number and egg-size to a continually changing environment.

## SUMMARY

(1) In the course of its life a fish belongs successively to several populations (e.g. larvae, young fish, adult fish). This paper deals with the inter-relationship between the larval stock and the adult stock.

In most years recruitment is not sufficient to fill up the total number of vacant niches in the adult stock. Recruitment to the adult stock seems to vary independently from parental stock while the number of eggs spawned per season depends directly on the size and average age of the parental stock.

(2) This might be explained in two alternative ways:

*First hypothesis:* The number of recruits is determined by a "gate" which permits only a given number (from year to year somewhat changing) of offspring to pass through. This hypothesis implies a regulatory mortality which compensates for differences in the number of eggs. Very little evidence is available for a density-dependent mortality of eggs and larvae. The following effects of the parental stock on larval survival are discussed, although they have rarely been shown to be serious in marine fish. Negative effects may be due to a low average age (e.g., in a heavily fished stock) and/or poor feeding conditions of the mother (by adverse environmental conditions, overcrowded feeding grounds).

*Second hypothesis:* There is a correlation between the parental stock size and recruitment, although it is normally not detectable in the relatively short periods of observation, being masked by bias in sampling and especially by natural fluctuations. In a completely stable environment and in case of constancy of spawning place and time, adaptation by selection would result in a decreasing larval mortality and by this in increasing stock size toward the complete filling up of the carrying capacity of the habitat. Most changes in the hydrographical regime, however, will have adverse effects on the survival of the larvae, until a new adaptation takes place.

(3) Although starvation and predation are not related to the abundance of larvae, they change considerably with time and place of spawning. The first and second hypothesis meet in this relationship. With increasing of the adult stock size spawning time and spawning area may change. These will adversely influence survival of larvae and act as regulatory mechanisms against a further increase of recruitment and stock size. The ratio of egg size to egg number in herring has been studied as an example of the adjustment of reproduction to the given environmental conditions of the early larval phase. The ratio differs between the spawning groups according to their differences in spawning time. Under low pressure of predation but under unfavorable feeding conditions (winter-larvae), a population of few but big and vigorous larvae may give a higher number of survivors than a dense population of small larvae.

Experiments with herring eggs and larvae are described. Compared with the larvae of the summer spawners, larvae from big eggs are longer at hatching and have a bigger yolk sac, which lasts over a longer period. These larvae start feeding at a far more advanced stage which gives them a better chance for getting more and bigger food organisms.

## REFERENCES

- Ahlstrom, E. H. 1954. Distribution and abundance of egg and larval populations of the Pacific sardine. *U.S. Dept. Interior Fish and Wildl. Ser. Fish. Bull.* 93: 83-140.
- Alderdice, D. F., W. P. Wickett and J. R. Brett. 1958. Some effects of temporary exposure to low dissolved oxygen levels in Pacific salmon eggs. *J. Fish. Res. Bd. Canada*, 15(2): 229-49.
- Anokhina, L. E. 1960. Interrelations between fecundity, variability of the size of the eggs and fatness of mother fish in Omega herring. *C. R. Acad. Sci. U.S.S.R.* 133(4): 960-63.
- Beverton, R. J. H., 1962. Long-term dynamics of certain North Sea fish populations, p. 242-59. In E.D. Le Cren and M. W. Holdgate, [eds.] *The exploitation of natural animal populations*, Blackwell, Oxford.
- Beverton, R. J. H. and S. J. Holt. 1957. On the dynamics of exploited fish populations. *Fish. Invest. Lond.*, Ser. II, 19: 553 p.
- Blaxter, J. H. S. and G. Hempel. 1961. Biologische Beobachtungen bei der Aufzucht von Heringsbrut. *Helgoländ. Wiss. Meeresunters.*, 7(5): 260-83.
- Blaxter, J. H. S. and G. Hempel. 1963. The influence of egg size on herring larvae. *J. Cons. int. Explor. Mer*, 28: 211-40. herring larvae. *Rapp. Cons. Explor. Mer*, 154: (in press).
- Gulland, J. A., 1962. The application of mathematical models to fish populations, p. 204-20. In E. D. LeCren and M. W. Holdgate, [eds.] *The exploitation of natural animal populations*, Blackwell, Oxford.
- Hardy, A. C., 1959. *The open sea: its natural history*, part II, Fish and Fisheries. Collins, London. 322 p.
- Hart, J. L. and A. L. Tester. 1934. Quantitative studies on herring spawning. *Trans. Amer. Fish Soc.* 64: 307-12.
- Hempel, G. 1963. On the causes of changes in recruitment. *Rapp. Cons. Explor. Mer*, 154:17-22.
- Hempel, G. and J. H. S. Blaxter. 1963. On the condition of herring larvae. *Rapp. Cons. Explor. Mer*, 154:35-40.
- Herrington, W. C., 1948. Limiting factors for fish populations. *Bull. Bingham Oceanogr. Coll.* 9 (4):229-79.
- Holliday, F. G. T., J. H. S. Blaxter and R. Lasker. 1964. Oxygen uptake of developing eggs and larvae of the herring (*Clupea harengus L.*) *J. mar. biol. Ass. U.K.*, 44:711-723.
- Krivobok, M. N. 1961. The relationship between the spawning time and the fecundity of *Clupea harengus membras*. *Trudy V.N.I.R.O.* 44: 160-63.
- Lea, E. 1930. Mortality in the tribe of Norwegian herring. *Rapp. Cons. Explor. Mer*, 65: 100-17.
- Lillelund, K. 1961. Untersuchungen über die Biologie und Populationsdynamik des Stintes *Osmerus eperlanus eperlanus* (Linnaeus 1758) der Elbe. *Arch. Fisch. Wiss.* 12: 1-28.
- Meyer, H. A., 1878. *Biologische Beobachtungen bei künstlicher Aufzucht des Herings der westlichen Ostsee*. Berlin.
- Nikolski, G. V. 1961. On the causes of fluctuations in the number of fish. *Voprosi Ichthyol.* 1: 659-65.

- Nikolski, G. V. 1962. On some adaptations to the regulation of population density in fish species with different types of stock structure, p. 265-82. In E. D. LeCren and M. W. Holdgate, [eds.] The exploitation of natural animal populations, Blackwell, Oxford.
- Nishimura, S. 1957. Some considerations regarding the amount of foods daily taken by an early postlarva of sardine. *Ann. Rept. Jap. Sea Reg. Fish. Res. Lab.* 3: 78-84.
- Olsen, S. 1961. Contribution to the biology of herring (*Clupea harengus*) in Newfoundland waters. *J. Fish. Res. Bd. Canada*, 18: 31-46.
- Outram, D. N. 1958. The magnitude of herring spawn losses due to bird predation on the west coast of Vancouver Island. *Fish. Res. Bd. Canada, Pacific Prog. Rept.*, No. 111: 9-13.
- Parrish, B. B., A. Saville, R. E. Craig, I. G. Baxter and R. Priestly. 1959. Observations on herring spawning and larval distribution in the Firth of Clyde in 1958. *J. mar. biol. Ass. U.K.*, 38: 445-53.
- Petersen, C. G. J. 1918. The sea bottom and its production of fish food. *Rep. Dan. Biol. Sta.* 25: 1-62.
- Radovich, J. 1962. Effects of sardine spawning stock size and environment on year-class production. *Calif. Fish. & Game* 48 (2): 123-40.
- Ricker, W. E. 1954. Stock and recruitment. *J. Fish. Res. Bd. Canada*, 11 (5): 559-623.
- Rollefesen, G. 1932. The susceptibility of cod eggs to external influences. *J. Cons. int. Explor. Mer*, 7: 367-73.
- Runnström, S. 1942. Quantative investigations on herring spawning and its yearly fluctuations at the west coast of Norway. *Fiskeridir. Skr. Havundersøk.* 6 (8): 1-71.
- Sette, O. E. 1943. Biology of the Atlantic mackerel (*Scomber scombrus*) of North America. Part I. Early life history. *U.S. Dept. Interior, Fish and Wildl. Ser. Fish. Bull.* 50 (38): 149-237.
- Thorson, G. 1958. Parallel level-bottom communities, their temperature adaptation, and their "balance" between predators and food animals, p. 67-86. In A.A. Buzzati-Traverso [ed.] Perspectives in marine biology, Univ. of California Press.

# PROBLEMS OF FISH-LARVAE SURVIVAL IN NATURE AND THE REARING OF ECONOMICALLY IMPORTANT MIDDLE EUROPEAN FRESHWATER FISHES

WILHELM EINSELE<sup>1</sup>

Federal Institute for Aquatic Research and Commercial Fisheries  
Scharfling, Austria

## INTRODUCTION

In early times, when fish culturists began artificial brooding of fish eggs and consequent stocking of natural waters with fry, the value of these activities was unquestioned. It was naively taken for granted that if this practice were followed, one would more than make good the decrease of fish populations caused by commercial fishing. The complexity of the problems, as we now know them—or believe to know them—was not readily seen, but it seemed sound to believe that since eggs and fry were much more protected in the hatchery than in the wild, the percentage surviving to adult fish should be much greater. As we all know, the experiences with most methods and concepts did not lead to the expected successes. Many people working in fisheries management now think that the time is ripe for discarding the whole scheme.

Are they justified or would it be worthwhile to try again? Naturally not in the way it was done before, but with modern concepts based on special analyses. In my opinion, the effort should be made. What are the reasons for my optimistic views? At the beginning let me put forward two principal statements based on the results of studying fry of various salmonid fishes, but especially white fish (*Coregonus* spp.) and brown trout (*Salmo trutta*). (1) It is now firmly established that in our alpine lakes only one to ten adults will result from 10,000 naturally-spawned coregonid eggs. (2) On the other hand it is not difficult to raise the percent larval survival in the laboratory from 0.1 or 1 per thousand to practically 100 percent. No special devices are needed. One need only offer the fry enough light (over 100 lux) and a high enough density of zoo-plankters, preferably *Diaptomus* copepodites, and the mortality will approach zero. With a lowering of the food density and/or the light, survival will diminish and finally will reach zero. Therefore by varying these two natural environmental conditions, you may have 100 percent survival or none at all.

A series of experiments summarized in Table 1 which I performed 20 years ago show this double dependency. The experiments were carried out in glass tanks. Light intensity at the surface was measured with a Lange Photometer. The food concentration was chosen to approximate that found in the Mondsee in March.

At a light intensity of 600 lux, as seen in Table 1, the density of food organisms plays an important

role in influencing the *number* of fry that feed. If, however, an individual fry is able to capture food organisms at a high food density, it will also capture almost as many organisms in all except the lowest food densities.

TABLE 1  
THE EFFECT OF LIGHT INTENSITY AND FOOD DENSITY (COPEPODITES) ON THE RATE OF SURVIVAL OF COREGONUS FRY

No. copepodites per liter	% of Fry feeding at lux							Relative feeding index								
	600	100	40	20	10	1	0.5	0.3	600	100	40	20	10	1	0.5	0.3
4.....	20	20	0	0	0	0	0	0	1.5	1.0	0	0	0	0	0	0
12.....	45	50	25	5	0	0	0	0	2.1	1.0	1.4	1.8	0	0	0	0
36.....	70	60	25	5	0	0	0	0	2.0	1.4	1.8	2.0	0	0	0	0
110.....	85	75	80	15	10	0	0	0	2.1	1.8	2.0	2.3	2	0	0	0
330.....	95	90	80	40	25	10	5	0	2.6	2.5	2.8	2.4	2.2	2.0	2.0	0
1000.....	100	95	100	60	35	20	15	0	2.8	2.9	2.7	2.4	2.4	2.5	1.3	0

Legend to Table: Coregonid fry of the Mondsee-race were used in this experiment. The left half of the Table shows the percentage of fry that fed at the different light intensities and the varying food-densities to which they were exposed. The right half of the Table gives the average relative amounts of food eaten by fry under the different conditions. Relative amounts are indicated by 0—none eaten; 1—one to three copepodites eaten; 2—gut partially filled; 3—gut well filled. Four copepodites per liter were chosen as a minimum experimental number on the basis of average numbers of copepodites per liter found in the Mondsee in March.

At a light intensity of 100 lux, one finds that there is practically no change in the percentage of feeding fry from that at 600 lux, although the relative *amount* of food that a fry eats is much lower at 100 lux than at 600 lux.

Other illuminating comparisons can also be made. In particular the one between feeding conditions (as expressed by light intensity and food density) and individual feeding capability (as expressed by the filling of the gut). The bottom horizontal row of figures in Table 1 shows that at a density of 1000 food organisms per liter, there is no significant difference in the percentage of fish feeding at light intensities of 600 to 40 lux; the percentage feeding then decreases rapidly. However, the amount that was eaten by those individuals which did feed was almost equal, down to a light intensity of one lux. These data are illustrative of the problem and the existence of individuality not only among the members of a single species, but also of a single race.

Two major questions seem to remain outstanding at this point. (1) What is the relation between the experimentally established data, illustrated in Table 1, and the natural ecological conditions of lakes contain-

<sup>1</sup> Translated by George O. Schumann.



ing coregonid fishes? and (2) In what way can the data provided by Table 1 be used to advantage in improving stocks of harvestable fish?

I shall discuss first the question of the relation between experiment and nature. Coregonid fishes spawn in cold water—some species and races on the falling water temperatures in the Fall, others during the Winter, and some upon rising temperatures in the Spring. The spawning habits and seasons of the same species may vary considerably in different lakes. In all cases, however, the spawned eggs sink to the lake bottom and, in most of them, spend all their developmental time at a temperature of 4° C. Approximately 75 to 80 days are required for development to hatching at this temperature, and fifteen days for the absorption of the yolk sac to a stage when the yolk-sac fry first begins to feed. The total developmental time from newly spawned egg to free-swimming fry is about three months. At this stage the fry are very small and live in open waters, or the pelagial zone of lakes. At the time of first feeding, a critical stage in the life history of the fry makes its appearance.

In most Austrian, South-German, and Swiss lakes coregonid fry are faced with the critical stage during February and March. The lakes may then still be covered with ice and snow and light intensities may reach very low levels at the water surface.

In the case of very deep lakes which do not freeze over, an unstratified condition exists and strong winds will cause a complete overturn of the water mass. Some deeper alpine lakes have an ice cover only once in three to seven years. Even though some deeper lakes may not freeze over—low temperatures reduce the amount of plankton to very low levels—in particular, copepodites are rare and nauplii are just beginning to appear. There may be as few as 30,000 to 50,000 copepodites below one m<sup>2</sup> of surface. Even these few organisms may be scattered into the depths by winds causing circulation of the lake water, resulting in densities of a few or only one “edible” crustacean per liter.

Feeding conditions for fry improve as the year proceeds. By the end of March the ice cover has left most of our lakes and from April on there will be more and more copepodites under one square meter of lake surface. The chances for a complete overturn of the lake occurring becomes less and less and by the end of April or early May, stable stratification is the rule. At this time copepodites concentrate between 0 and 7 m depth. Concomitantly, length of day and light intensity may rise above 100 lux and the number of copepodites per liter may increase to 20 or more. Should fry be stocked at this time it would seem that the chances of survival should be greater.

### THE EFFECT OF TEMPERATURE

If it is true that the survival rate and feeding conditions are closely related as our experiments show, we should plant fry in late April or May to increase percent survival. The proper timing can be

achieved by manipulating temperature during development. I have been investigating the duration of development of fish eggs in relation to temperature on a broad scale. My results may be summarized as follows:

In general, European freshwater fish eggs develop within a temperature range of 0–27°C. Different fishes have different levels in this range. Coregonids and brown trout may be cultured at temperatures from 0–12°C with about equally good results. Char eggs produce exceptionally vigorous fry at 0°C, and losses begin to occur at 8–9°C caused by cracking of the egg-shells sometime before hatching. Northern pike has its safe interval between 6 and 18°C and carp between 15 and 27°C.

If the temperature is lowered by 10°C, developmental time increases by 5 times. This means that the time from fertilization to the feeding stage of coregonid eggs can be as short as 35 days or as long as six months. Therefore we are able to release feeding coregonid fry at a time when the chances for survival are maximal.

Formerly well water was used in many hatcheries because it is free of turbidity, relatively free of bacteria and not in danger of freezing. In our region well water has a fairly constant temperature (ca. 8°C). Coregonids take about 50 days to develop at this temperature which is at the upper range of their temperature tolerance. Because most coregonid races spawn between the second half of November and the first half of January, the fry from the hatcheries using well water had to be released in January or February. In performing this, holes had to be made through the ice and snow-covered lakes frequently. Stocking in this manner had little or no effect on the fish population!

Eggs of the European brown trout need 1.6 times the time for development needed by coregonid eggs at any temperature; however, considering only the interval from hatching to ready-to-feed size, trout fry need about 3 times as many days as the coregonid fry.

The velocity of development is increased or diminished 15 to 16% by a 1°C difference. The rate stays the same over the whole temperature range. Thus in coregonid and trout eggs this percentage is the same at the freezing point and 8 or 9°C above it. Furthermore the temperature coefficient ( $Q_{10}$ ) of developing fish eggs may be as high as 5 while simple chemical reactions speed up 2 to 3 times by raising the temperature 10°C. All of the chemical and physical reactions occurring in embryological development may occur harmoniously and at very high rates, which is a remarkable achievement indeed.

### THE FOOD SITUATION IN ALPINE LAKES

In Alpine lakes the feeding situation for coregonid fry does not improve continuously as the year proceeds. Rather there is a turning point in May. Toward the end of May diurnal plankton migration sets in and carries the crustacean plankton down to 10–20 m

during the daytime. The critical light intensity for the fry may be at 5 m and is certainly too low below 10 meters.

Two other "negative" factors may also exist. The size of zooplankters may be inappropriate. In our "home lake", the Mondsee, *Daphnia longispina* prevails in May, comprising 95% of the whole zooplankton mass. *Daphnia*, however, is too big to be eaten by coregonid fry.

### SURVIVAL OF ALPINE FISHES

Thus far my intention has been to show how environmental conditions seem to determine the rate of survival in coregonid larvae. In the field these can be shown even more convincingly.

#### *Carp ponds*

To be suitable for coregonids, carp ponds should not be too small nor too shallow. They should have an area of several acres and a depth of 2 to 3 m, and be situated in regions where it does not get too hot, so that the water will not warm up above 20° C.

If one stocks a carp pond with coregonid fry, even right after the ice is gone, not less than 10 or 20% of the fry survive; a very good survival. But natural reproduction in these ponds is not possible because the eggs fall to the muddy bottom, are covered by silt and die.

#### *Creeks*

Stocking of brown and rainbow trout fry in creeks results in poor yields. Removal of the adults which are predators and also competitors for food will change the percentage of survival drastically. This was shown by the following field experiment. If we remove all the trout of a creek by means of electrical fishing gear and then stock it with fry, half a year later up to 50% of the fry may be harvested as fingerlings 7.5–13 cm long. Floods may diminish this percentage because the young fish may be driven downward into the bigger main river while simultaneously larger specimens living in this area may swim up and enter the stocked area, acting as predators. The rate of survival of stocked trout fry may be cut down to 10 to 20% but compared with the natural survival these figures are still very high.

Summarizing our trout fry creek-stocking results the following criteria are now used: Creeks should be 1) about 1–3 m wide; 2) 15–30 cm deep; 3) "summer cool"; 4) pass through agricultural areas which allow continuous "homeopathic" fertilization; 5) flow at a moderate speed not exceeding 32 cm/sec; 6) not endangered by floods; 7) have bottoms covered with gravel 2.5–10.5 cm in size; 8) interrupted by waterfall-steps (of a height of 12.5–30 cm) followed by small pools; 9) and have frequent hollows in their shoreline.

In such creeks, previously freed of all trout, then stocked with 50,000 fry per mile, it is sometimes possible to harvest 15,000–20,000 fingerlings per mile, with an average length of 10 cm each.

### POPULATION DYNAMICS AND PHYSIOLOGY OF COREGONID RACES IN AUSTRIAN LAKES

It is not without reason that I place Ecology and the study of population dynamics foremost in fisheries research. A particularly good demonstration of this is offered by studies on the ecology of the young of various races of coregonid fishes.

Small physiological and morphological differences may, in certain biological situations, decide whether a larva lives or dies, hence these differences probably arose in response to factors influencing survival. Death or survival is determined by the interplay of two groups of conditions: the milieu and the innate larval character.

The principal deciding factors in the dynamics of space and time in the milieu have already been discussed; now the characteristics or peculiarities of the larvae will be considered. We have heard previous speakers discuss some aspects of the biology of her-ring, sardine and flounder larvae. The freshwater fish I have been discussing (*Coregonus* spp.) somewhat resembles the marine herrings in form and habit.

The European species of coregonids have been isolated since the end of the last glacial period, and although a species may have a wide distribution, in many cases each lake has evolved a distinct form or race. Sometimes more than one species may be found in the same lake but in this case each species has adapted to a particular niche. Presumably in like manner each lake has presented specific ecological demands to a species upon its entry into the ecosystem with the resultant evolutionary tendency, noteworthy in this family, to differentiate. Many of the racial characteristics such as egg size, oxygen requirements, etc., have become genetically fixed, while other characters, usually morphological, may be quite plastic.

#### *Physiology*

In this respect some of the physiological phenomena in the further development of coregonid larvae may be considered.

Catabolism (measured by loss of dry weight) and water uptake.

- a. Continual weight measurements beginning with the first day after hatching in unchanging temperature show that the dry substance of larvae is steadily reduced.
- b. If an unfed larva dies after utilizing all of its yolk reserve and other absorbable body tissue the body generally is reduced, depending upon races, to 40–60% of its hatching dry weight.
- c. The fresh body weight, on the other hand, behaves quite differently. During the passage of the first quarter of life after hatching the fresh weight increases slightly (about 10%), then decreases until death. Immediately before dying, the fresh weight is still 80% of the hatching weight. The water content of the larvae, beginning with hatching, continually increases. In this context the water content after hatching

amounts to 75%; at death about 90% of the fresh weight.

If one investigates eggs and larvae of the various coregonid races, one notices, first of all, a marked size difference. Egg and larval weights of the ten coregonid races investigated in the region of the northern Alps, vary in the relationship 1:2, or between 3.5 and 6.5 mg. Since the larval weight is proportional to the third power of the length, the length varies far less when expressed in absolute numbers. At the stage of first feeding, the length of the smallest coregonid larva is 9 mm and those of the largest group 11 mm. These small differences are significant. Since he is concerned with law and order, the theoretical biologist has an immediate interest in creating a biological model and this often means that small differences are overlooked. How little a model would indicate the heart of coregonid larval biology is shown by the results of the following simple comparative investigations.

An equal number of feeding sized coregonid larvae of various races were placed in groups of aquaria, and supplied with a known, and always equal number of crustacean plankters. The size of the zooplankters was varied in the various groups of experimental aquaria. Food density and illumination were judged to be optimal in all tests (levels of illumination exceeded 600 lux in all tests and food density was high). The results are summarized below and in Table II.

1. Tests with extremely large food organisms resulted in only a small percentage of the most capable race of larvae (the lake Hallstätter fish) being able to capture food and survive; the remainder starved.

2. Races of larvae only one mm smaller than the Hallstätter failed completely under such feeding conditions.

3. With the food size reduced, conditions would be easily established by which the Hallstätter larvae survived for the most part (75%) while about 10% of the larvae averaging one mm smaller (Mondsee fish) succeeded in finding food. The smallest race of larvae (Attersee fish) with a length of about 9 mm, still found nothing to feed upon and eventually all starved.

4. When in the course of the tests an even smaller sized food was offered (principally small to medium-sized stages of *Daphnia*) an increased feeding capability was observed for the smaller larvae. One could, on the other hand, increase the test sensitivity to food size at will by combination with graduated light intensity.

The simple determination of size differences in the larvae of various coregonid races naturally does not offer a key to the biology of the various races. Various sized food organisms were obtained from the Mondsee by the use of graded plankton nets. The measurements given in Table 2 represent the mean opening of the net mesh. Each test ran for two hours during which fish were allowed to feed. The data on stomach contents given in the table refer to relative numbers; i.e., the "fullest" stomachs were equated to 100.

TABLE 2  
PERCENTAGE OF FEEDING COREGONID LARVAE IN RELATION TO SIZE OF THE FOOD ORGANISM

Food Size in Microns	Hallstätter fish Av. Wt. 5.6 mg		Mondsee fish Av. Wt. 4.4 mg		Attersee fish Av. Wt. 3.7 mg	
	% Feeding	Fullness of Stomach	% Feeding	Fullness of Stomach	% Feeding	Fullness of Stomach
470-----	15	10	0	--	0	--
370-----	75	60	10	5	0	--
250-----	100	75	45	25	40	20
180-----	100	90	65	55	65	40

Various sized food organisms were obtained from the Mondsee by the use of graded plankton nets. The measurements given in microns in the Table represent the mean opening of the net mesh. Each test ran for two hours during which fish were allowed to feed. The data on stomach contents given in the Table refer to relative numbers; i.e. the "fullest" stomachs were equated to 100.

In the laboratory, newly hatched larvae of all but one of the races investigated showed not the slightest interest in food—no matter how ideally offered. Only when the yolk sac is absorbed to a certain degree (thus the passage of a definite time-temperature span) is there awakened an interest for food in the larvae which begin feeding.

For the large race of the Hallstättersee this stage is reached at a dry weight of larvae of about 20% of the fresh weight. The larvae of the large pelagic race of *Coregonus* in the Traunsee behave similarly. In both cases we are dealing with relatively large larvae with an average fresh weight of about 6 mg. Investigations such as these were carried out during many periods of the year. It was demonstrated repeatedly, that the established values were quite nicely replicated.

In smaller races of larvae it was generally established that they only begin feeding very late in development; i.e. at a low percentage dry weight. The smallest larvae, the Attersee race, begin their feeding last at a dry weight of 16% of the fresh weight.

If one determines the time at which only 50% of a group of starved larvae are still capable of feeding, the sequence for the various races of larvae is reversed from that of the "first feeding" test. The larvae which began feeding last were also the earliest to become too weak to feed. Thus, for example, 50% of the large pelagic coregonid larvae of the Traun- and Hallstättersees still fed at a mean relative dry weight of 13%, while the small larvae of the Attersee reached this state with a relative dry weight of 15%.

Larvae from the Lake Hallstätter race were so weak at a relative dry weight of 10%, and those of the Attersee race at 14%, that all the members of test groups were unable to capture food when these weights were reached.

In other words, the various races of larvae remained capable of feeding for varying lengths of time after a period of starvation. If one expresses the times in days (at the uniform temperature of 5° C) then one obtains a time of 2 days in the most unfavorable case, and 23 days in the most favorable case (Table 3, vertical column to the right). During these times, of

course, conditions of optimal food density, food size and intensity of illumination prevailed.

TABLE 3  
DEVELOPMENTAL RATES OF COREGONID LARVAE TESTS WERE CONDUCTED AT A TEMPERATURE OF 5° C

Coregonid Race	Fresh Weight of newly hatched larvae (mg)	Time at which 50% of the larvae begin feeding (days)	Duration of feeding capability after starvation (days)
Hallstättersee.....	5.6	33	23
Traunsee.....	5.8	33	23
Bodensee*.....	6.5	31	12
Obertrumersee.....	5.6	25	10
Bodensee†.....	4.6	17	4
Mondsee.....	4.5	23	5
Attersee.....	3.7	12	2

\* Littoral form.

† Pelagic form.

It seems pertinent to mention here two exceptions, because these show that one can never be certain whether laws or conformities established for a particular situation also apply in general. In this case, the exceptions concern the larvae of the Bodensee whitefish *Coregonus macrophtalmus* and the larvae of the whitefish living in the Obertrumersee near Salzburg.

The noteworthy thing about the Bodensee whitefish and one which earlier investigations noted, was that the embryonic development took longer than is usual for the European coregonids. In fact, the longer developmental time means that those larvae at hatching are considerably more physically advanced than the larvae of any other European whitefish. The relative dry weight of the Bodensee whitefish is, just after hatching, somewhat more than 18% of the fresh weight. This is smaller than the relative dry weight of the Hallstätter whitefish larvae in a stage when 50% of these larvae begin feeding.

The Bodensee whitefish has the largest larvae of all the investigated European coregonids, and unlike most coregonids begins feeding almost immediately after hatching. One can, by means of a simple manipulation, induce the Bodensee whitefish eggs to hatch prematurely. This is done by raising the water temperature above 10° C near the end of the embryonic period of these eggs, which causes hatching at the same time as other races of coregonids. The relative dry weight of these newly hatched Bodensee larvae was found to be not the normal 18%, but in this case 25% of the fresh weight. The Bodensee larvae caused to hatch prematurely, but otherwise normal, showed no more interest in food than newly hatched Traunsee or Hallstättersee larvae. Most interestingly, however, they began to feed first, at a relative dry weight of 18.2%; thus at precisely the dry weight with which they normally begin to feed. (The Hallstätter larvae begin feeding at 20%).

We can see, therefore, that the general principle of the largest larvae feeding first does not always hold true.

Noteworthy peculiarities came to light during the investigation of Obertrumersee coregonid larvae. The size of the larvae of this race is about the same as the Hallstätter and Traunsee larvae. Against all expectations, however, the Obertrumersee larvae reached the stage of first feeding considerably later than any of the other larvae investigated, and on the other hand, became too weak to feed in a shorter time. As can be seen in Table 3, the duration of full-feeding capability lasted only 10 days.

Also in other tests (for example, the determination of minimum oxygen concentrations, food size) Obertrumersee larvae averaged poorer than similarly sized relatives from other lakes. One must conclude that there are cases in which other factors besides size are important, a type of superior instinct, or vitality, or both must also play a role.

#### Minimum oxygen requirements

Various fish species require differing, but usually family characteristic demands on the minimum oxygen concentration of the habitat. The salmonids need at least 3-4 mg/liter, the cyprinids 0.5-1 mg/liter.\*

If one investigates the larvae of various races of coregonid fishes with this in mind, one finds astonishingly large variation, although still within the generally high values required by all salmonid fishes.

The studies reported here were carried out in the following way: feeding larvae were placed in all glass aquaria and 1) the oxygen concentration measured when 50% of the larvae lay motionless on the bottom; and 2) the oxygen concentration at which all larvae lay motionless on the bottom. In general, ten tests were made with each group of larvae, and it is emphasized that the test replicates gave oxygen values which at the most diverged only 13% from each other. If one considers, on the other hand, the performance of each of the individuals tested within one race, one finds again important and characteristic differences. At a water temperature of 6.5° C, suffocation began at 6 mg O<sub>2</sub>/liter while a few larvae held out until an oxygen concentration of 1.9 mg/liter.

We will see later, that the smaller races of larvae require a much higher minimum oxygen concentration than the larger races. One can legitimately connect these differences with innate resistance because when one conducts an oxygen test with coregonid larvae which are a few days away from dying, a 2-7 mg/liter higher minimum oxygen concentration is recorded.

At higher temperatures the required minimum concentrations are generally higher than at lower temperatures. One must therefore always work with the same temperatures when making comparisons.

Table 4 presents several characteristic oxygen values for larvae of the Hallstätter coregonid. The values given in Table 4 are average values which are reliably reproducible. On the other hand, however, the variation in the reactions of single individuals in a test is rather high, but also very reproducible. A test of the

\* To convert mg O<sub>2</sub> to ml O<sub>2</sub> multiply by 0.7 (approximate).

latter type is given in Table 5. This test deserves special interest because here rather exact estimates of the variations in individual behavior were made at various temperatures on the larvae of Hallstätter whitefish.

**TABLE 4**  
**MINIMUM O<sub>2</sub> CONCENTRATION REQUIRED AT VARIOUS TEMPERATURES FOR HALLSTÄTTER LAKE COREGONID LARVAE**

Temperature	O <sub>2</sub> Concentration at which 50% of larvae lay motionless at the bottom of the aquarium, mg/liter	O <sub>2</sub> Concentration at which 100% of larvae lay motionless at the bottom of the aquarium, mg/liter
6.5°-----	3.3	1.9
11.5°-----	3.7	2.1
19°-----	5.5 (†)	4.4 (†)

**TABLE 5**  
**THE O<sub>2</sub> CONCENTRATIONS AT WHICH THE FIRST 10% OF LARVAE LAY MOTIONLESS ON THE BOTTOM**

Temperature	The first 10% of larvae on bottom at mg/L O <sub>2</sub> .
6.5-----	6
11.5-----	6.9
19-----	7.5

**TABLE 6**  
**OXYGEN CONCENTRATION (MG/LITER) AT WHICH 50 TO 100% OF THE LARVAE OF DIFFERENT RACES DIED (11.5° C)**

Race	Weight of Larvae in mg.	Oxygen concentration at which 50% lay motionless on bottom (Average values)	Oxygen concentration at which 100% lay motionless on bottom (Average values)
Hallstättersee-----	5.6	3.7	2.1
Traunsee-----	5.8	3.9	2.0
Bodensee*-----	6.5	4.3	2.6
Obertrumerssee-----	5.6	4.3	2.6
Bodensee†-----	4.6	4.3	2.6
Mondsee-----	4.4	4.3	2.8
Attersee-----	3.7	4.9	3.1

\* Littoral form.  
† Pelagic form.

In Table 6 all tests have been compiled which were made with larvae of various races. Among the various races of larvae, three groups are easily distinguishable: one particularly viable group of larvae (Hallstätter—and Traunsee); a homogeneous middle group on the basis of their oxygen requirements; and the race least vigorous in this respect, the whitefish of the Attersee.

The middle group is very close to the uppermost group in its minimum oxygen tolerance. However, it is highly noteworthy that the middle group contains larvae of considerable size variation. The Bodensee whitefish, and the whitefish of the Obertrumerssee seem to be out of sequence. If larval weight alone were

decisive, the Bodensee larvae would occupy the top position and the fish of the Obertrumerssee would also be in the upper group.

The sensitivity of various races for low oxygen concentrations is connected somehow with a "resistance factor", which would probably be shown in tests made with material having a poisonous effect, such as ammonia or chlorine. It is more than probable that one would find similar differentiating characteristics for the larvae of various races.

**FROM LARVAE TO ADULT**

When one reflects on the seemingly simple, but biologically complex fact, that survival among the larvae of many fishes is one in several thousand, while at the same time individuals once having attained a few centimeters in length stand a hundred or thousand fold chance of survival, one is led to the conclusion that a "species"—consists ecologically of many distinct though related parts. By this is meant that fish go through, on the way through larval to metamorphosed or adult forms, such important transformations, that it would appear rewarding, even necessary, to reinvestigate and describe them in certain time intervals.

It should be possible to test anew each stage in larval transformation, and possibly juvenile stages as well, to learn how and when the greatest losses in stock occur. One would surely learn that many of the dangers and sensitivities of one growth period are not so much lost in a succeeding period, but merely exchanged for new difficulties. Presumably, however, factors such as size and concentrations of food organisms along with intensity of illumination, become as always of less importance for survival at each succeeding growth stage. In coregonids, for example, fish of a length of about 25 mm and a weight of 100 mg are fully developed; the entire body is scaled, the swim bladder is filled, and the fins developed.

The differences between the index of survival or "stock potential" of larvae versus fully developed fry can be demonstrated most conclusively when one stocks lakes, which previously were without whitefish, with either feeding larvae or fully developed fry (of about 30 mm). We have performed this type of "big" experiment many times. The success of the experiment is determined naturally only by the later capture of grown fish. Although one cannot term this method an exact test of degree of development or maturity upon rate of survival, the scope of such biological experimentation leaves no other practical conclusion. In any event, some noteworthy results have been realized. In one lake we stocked one million whitefish larvae without a single grown fish being captured in the following years, despite all our efforts. In other similar cases the results were not much better. However, at least a few fish were later captured, but frankly 1 animal per ten thousand was never exceeded.

Stocking experiments utilizing fully developed fry gave completely different results. In one case we cap-

tured not less than 25% of the stocked fish as adults, and in other cases, which we could not hold so completely under our control, at least 10% of the fish were captured as adults. We naturally presume that the captures represent the minimum survival of stocked fish—as many, or more fish remained at large and therefore were not recognized as a surviving “percentage”.

Since we of this symposium are not dealing with special problems of management of whitefish lakes, I would like to point up, in closing, in the following special connection, some generally important facts. When one hopes to feed the larvae of any species of fish for any length of time and then release the fish in nature, a fundamentally important question arises: at what specific stocking size will the survival rate of cultured fish materially exceed that of the newly hatched, or wild fish? This question is at once clear when one considers the parallel increase in length and weight of growing larvae. The statement that a doubling of the length in young fish results in a 10 fold increase in weight, seems reasonably accurate upon examination. Young coregonids weigh about 15 mg at a length of 15 mm; at 20 mm, 40 mg; 30 mm,

150 mg; 40 mm, 400 mg, etc. It seems evident that, in light of these conditions, the expenditures necessary for rearing also increase about ten-fold with a two-fold increase in the length of the fish. Since as a rule, rearing of larval or juvenile fish deals with relatively very large numbers, a problem of considerable importance is to determine at which length, relative to rearing costs, the young fish achieve an optimum survival. One may attempt to determine this length or growth stage by experimentation. This length is that by which relative to the expenditure, a maximum yield can be expected. It is obvious that this type of experiment cannot alone deliver complete data. Thus, for example, nothing is said about the role of predators, disease, etc. on survival.

In any event, however, when fish are reared for the purpose of augmenting wild populations, the fluctuations of success will be determined when the young are released in nature. As I have shown in this paper, one may deduce important keys to the roles played by vague factors—complexes in population dynamics from variability and the different characteristics of natural waters. This should be so whether we are concerned with fish in a lake or the Pacific Ocean.

# KINDS AND ABUNDANCE OF FISHES IN THE CALIFORNIA CURRENT REGION BASED ON EGG AND LARVAL SURVEYS<sup>1</sup>

ELBERT H. AHLSTROM  
U.S. Bureau of Commercial Fisheries Biological Laboratory  
La Jolla, California

Egg and larval studies have formed an integral part of the research of the La Jolla Laboratory for 25 years. The first extensive survey cruise to determine the areal extent of sardine spawning was made in 1939 in cooperation with the Scripps Institution of Oceanography. Subsequently we have made egg and larval surveys in 18 additional years, all in cooperation with Scripps.

Although our studies have centered on the Pacific sardine, it soon became evident that the collections we were making were equally useful in assessing the distribution and abundance of the egg and larval stages of other pelagic fishes in the California Current system. It is this latter aspect of egg and larval studies that I wish particularly to develop in this presentation.

It is a fortunate circumstance that sardine spawning was found to have an extensive and varying areal and temporal distribution. Because of this, our surveys could not be limited to a part of the year or to a part of the California Current system off California and Baja California. We had to cover an extensive area systematically. Throughout the 1950's, egg and larval surveys were conducted at approximately monthly intervals. Only since 1961 have they been restricted to quarterly cruises.

There are perhaps three principal reasons why fishery scientists conduct egg and larval surveys.

(1) For one thing, scientists are interested in the present abundance of an adult fish population and its distribution at time of spawning, and they hope to determine this from the distribution and abundance of its pelagic eggs.

(2) Secondly, they are interested in the dynamics of a fish population; in how good or poor the year class resulting from the season's spawning will be; and in the reasons for the marked variations in survival that occur. They hope to determine this by systematically sampling the larvae and their environment during the spawning season.

(3) They are interested in marine fish resources, latent as well as exploited, and in their distribution, abundance, and interrelations. Since the majority of fishes have pelagic larvae and many have pelagic eggs, the studies can be carried out on these stages.

There are other reasons for conducting surveys in addition to the above. Fish eggs and larvae constitute only one of a number of groups of animals that make up the zooplankton community. Some zooplankters are predators on fish eggs and larvae while others constitute the food of developing fish larvae.

Hence, our studies must include the kind and amount of zooplanktonic organisms (including biomass estimates). Of primary importance is an understanding of the physical and chemical features of the dynamic ocean environment and their influence on productivity and on the distribution and abundance of fishes.

Let us consider for a moment a few of the problems involved in using planktonic fish eggs as a means of assessing the distribution and abundance of the adult population. The developing embryos in pelagic fish eggs cannot dodge a plankton net. They can be sampled quantitatively at any given place in the ocean merely by encompassing their vertical distribution with adequate gear hauled in a uniform manner. Utilizing the information on the distribution of eggs, the areal distribution of adult fish at time of spawning can be determined with considerable precision. The basic requirements are (1) extensive enough coverage in space to completely delimit the areal distribution of spawning and (2), surveys repeated at frequent enough intervals to delimit the spawning season in the several parts of a species' range. Delimiting the areal and seasonal distribution of spawning is a straightforward reconnaissance problem.

Estimating the amount of spawning within acceptable limits of precision is another matter, however. This is a far more difficult problem, as it involves the manner in which fish are distributed at time of spawning, the extent of spawning patches, the rate of diffusion of eggs away from such patches and many other variables that probably will differ for each species of fish being investigated. Our yearly estimates of sardine egg abundance are consistent enough to lend support to the determination that the fiducial limits for our annual egg estimates are roughly half or double.

Furthermore, if surveys were limited to this one aspect, it would be possible to devise sampling techniques that would increase reliability of sampling. We demonstrated that horizontal strip sampling along cruise tracks using a series of high speed samplers is an excellent way of integrating the patchy distribution of sardine eggs over area (Ahlstrom *et al.* 1958). We did not adopt this technique routinely because high speed samples were of limited value in collecting fish larvae. The volume of water strained was just too small to get an adequate size sampling of larvae. Even when employing only oblique plankton hauls made with our CalCOFI net, reliability of egg estimates can be enhanced by increasing the frequency of sampling within known spawning areas.

<sup>1</sup> Figures 1-15 appear at end of paper, pages 38 to 52.

We have found that estimates of larval abundance are more consistent than estimates of egg abundance. This is an interesting point, as it is often assumed that the reverse is true. In fact this latter opinion was expressed by Alan Saville in a review paper on egg and larval studies that he contributed to the ICES symposium at Madrid in 1963. I will present data to substantiate this point later in my talk.

Larval estimates are assumed to be less reliable than egg estimates when they are used for estimating the relative abundance of the various pelagic species spawning in an area. There is an element of truth in this. Considerable mortality has been experienced during both the embryonic and larval stages—and it must differ from species to species.

There are a number of advantages to using larvae in preference to eggs and none is more convincing than the following: larvae can be identified with more certainty. I need only mention the similarity in appearance of early stage gadid eggs that has plagued studies on the haddock or the difficulty that Tom English had in separating the early stage eggs of three species of flatfish so that he did his studies on reliability of estimates of egg abundance on composite samples of all three.

Then too there are more species represented as larvae than as eggs. Some fishes incubate their eggs and extrude them only when they hatch. There are some 50 species of *Sebastes* in California waters that are ovoviviparous, and some other fishes including *Brosmophycis*. Larvae of various species with demersal eggs also occur in the plankton; the Pacific herring, osmerid smelts, and cultus cod are examples.

There is another advantage for using larvae for estimates of abundance that appears to me to be of prime importance. The eggs of many of our common species—sardine, jack mackerel, Pacific mackerel hatch in 2 to 4 days at the temperatures usually prevailing in our waters. Hence, only as many days spawning can be represented in our collections. Larvae, however, require a month or more to develop through the size range we take in our samples. Thus a larval sample represents, in a real sense, an integration over time. With cruises spaced at monthly intervals larval numbers should adequately reflect the sequence of spawning. Another consequence of this accumulation is that larvae tend to be more widely distributed than eggs and hence taken in more collections.

I do not intend to go into the subject of larval survival to any extent. John Isaacs discusses this subject with respect to the sardine and anchovy in this symposium. A few aspects of this problem will be presented in a latter part of this paper.

Now that I have presented the case for using larvae, I will get to the main thesis of my talk, which is simply this; there is no better technique available for fish resource evaluation than systematic larval surveys.

I will remark to begin with that I am impatient with the often used excuse that such surveys are impractical because of the difficulty of identifying larval fish. There also are difficulties in identifying cope-

pods, medusae and most other groups in marine plankton. This has not prevented a number of scientists from becoming quite competent in the taxonomy of such planktonic groups. It is just one of the facts of life that a taxonomist has to expend rather considerable time and effort in learning his trade. Larval fish taxonomy is not a task to assign to a junior fishery biologist without experience in taxonomy.

It is very difficult to evaluate the kind and amount of our adult fishery resources. Bottom trawls could be used to collect a segment of the fish biomass, mid-water trawls another fraction, long-lines another, etc. This is because fish are so various with respect to size, depth distributions, behavior patterns, food habits, etc. Juvenile and adult fishes possess one characteristic in common, agility. This characteristic has led us to class fish as nekton.

Fishes are passive, however, or only moderately agile during their early development stages as embryos and larvae. Pelagic fish eggs and larvae are temporary members of the plankton community and can be sampled by plankton gear. The sampling problem of fish eggs and larvae is orders of magnitude more simple than with juvenile and adult fishes. It is possible to use fish eggs and especially fish larvae for resource evaluation because most marine fishes have a pelagic larval stage. The majority of pelagic fishes spawn their eggs in the open sea in a manner that permits each egg to be a separate, free-floating entity. Egg masses are the exception in the pelagic realm and only a few fishes like the flying fishes and atherinids spawn their eggs with strings attached.

At the risk of being repetitious, I will restate several points made previously. Ovoviviparous fishes, such as rockfish, coddle their embryos, but extrude their newly hatched larvae to fend for themselves in the open sea. The larvae of many fishes with demersal eggs become members of the plankton community. Only sharks and their relatives and a few marine teleost groups such as embiotocids completely bypass the planktonic larval stage.

The eggs and larvae of the majority of pelagic fishes have a relatively shallow depth distribution, occurring principally in the upper mixed layer. On CalCOFI survey cruises, we haul our plankton nets obliquely from about 140 meters deep to the surface. This depth of haul is enough to completely encompass the vertical distribution of most of our common fish larvae including sardine, anchovy, Jack mackerel, Pacific mackerel and rockfish.

On Norpac, the wide-ranging survey of the north Pacific made in August 1955, we sampled two depth levels, the usual upper level between 0-140 meters and the adjacent level between 140 and 280 meters. Only about  $\frac{1}{9}$  as many larvae were taken in the deeper level as in the upper; fully half of these were hatchet fish larvae, a group seldom taken in the upper level.

I have reached the point in my talk at which I would like to present several kinds of information simultaneously. These data are concerned with three things: kinds of fish larvae taken in our surveys, their numerical abundance, and their distributions.



I can cover the first item, kinds of larvae, very succinctly. There are many kinds of fish larvae in the California current area. Some are abundant, some are common, many more are rare. Over the years we have taken some hundreds of kinds of fish larvae.

When tabulating the numbers of larvae taken during a cruise or season, we soon noticed that most of the larvae belonged to relatively few kinds. By kind I am referring to species in most instances, but sometimes to genus.

Our data are most completely analyzed for the years 1955 through 1958. During these four years, 12 kinds of larvae made up between 90 and 93% of the larvae collected. These 12 kinds include two genera and 10 species. In three of the four years the same 12 kinds of larvae were the most abundant numerically, and in the remaining year, 1956, there were 2 displacements.

Of the 12 kinds of fishes that are consistently abundant as larvae, 6 are of present or potential commercial importance, 6 have no foreseeable commercial use. All 12 must be important in the food web.

The larvae making up the second group of 12 kinds, i.e., the larvae ranking between 13th and 24th in abundance, contributed 4.3 to 5.5% of the total during 1955 through 1958. Abundance of larvae of the more common species is summarized in Table 1.

The remainder, after both of the above categories are taken into account, constitutes as little as 2.7% of the total in 1955, 4.3% in 1958, 4.6% in 1956 and 5.5% in 1957.

It should be evident from the above groupings that a great deal could be learned about the fish resources of an area without identifying every larva. If only the larvae of the 25 most common kinds of fishes were known, for example, a name could be given to 19 out of every 20 larvae collected on our surveys. From the standpoint of biomass, these are the larvae of the fishes that will make up most of it.

I'm not suggesting that one's attention be limited to the common kinds of larvae. Far from it; many of the fishes of greatest interest to the larval taxonomist are in the 5% remainder, including some important apex predators.

TABLE 1

COMPARISON OF RELATIVE ABUNDANCE OF FISH LARVAE IN THE CALIFORNIA CURRENT REGION BASED ON YEARLY SUMMARIES OF NUMBER OF LARVAE OBTAINED IN PLANKTON COLLECTION FROM CALCOFI SURVEY CRUISES 1955-1958

	1955			1956			1957			1958		
	No. Taken	% of Total	Rank*	No. Taken	% of Total	Rank*	No. Taken	% of Total	Rank*	No. Taken	% of Total	Rank*
<i>Engraulis mordax</i> .....	140,183	39.03	1	134,931	33.05	1	146,631	29.70	1	205,457	45.21	1
<i>Merluccius productus</i> .....	60,090	16.73	2	94,277	23.10	2	78,283	15.86	2	58,368	12.84	2
<i>Sebastes</i> spp.....	29,344	8.17	3	29,144	7.14	3	36,473	7.39	4	23,931	5.27	4
<i>Citharichthys</i> spp.....	20,411	5.68	4	23,635	5.79	4	15,813	3.20	9	6,655	1.46	11
<i>Leuroglossus stilbius</i> .....	15,111	4.21	5	18,620	4.56	5	29,506	5.98	5	4,859	1.07	12
<i>Sardinops caerulea</i> .....	14,121	3.93	6	15,523	3.80	6	9,833	1.99	11	11,423	2.51	7
<i>Trachurus symmetricus</i> .....	13,246	3.69	7	8,027	1.97	10	20,006	4.05	6	6,409	1.41	10
<i>Lampanyctus mexicanus</i> .....	13,165	3.67	8	10,802	2.65	8	16,207	3.28	8	16,514	3.63	5
<i>Vinciguerria lucetia</i> .....	12,654	3.52	9	9,832	2.41	9	55,114	11.17	3	55,756	12.27	3
<i>Lampanyctus leucopsarus</i> .....	7,454	2.08	10	15,125	3.71	7	16,808	3.40	7	11,892	2.62	6
<i>Diogenichthys laternatus</i> .....	4,771	1.33	11	3,158	0.77	13	11,603	2.35	10	7,061	1.55	8
<i>Bathylagus wesethi</i> .....	3,245	0.90	12	2,146	0.52	17	6,347	1.29	12	7,021	1.54	9
<i>Lampanyctus ritteri</i> .....	1,988	0.55	13	1,924	0.47	18	2,789	0.56	14	3,091	0.68	13
<i>Pneumatophorus diego</i> .....	1,950	0.54	14	1,520	0.37	20	1,865	0.38	18	1,273	0.28	20
<i>Electrona</i> spp.....	1,823	0.51	15	1,852	0.45	19	1,415	0.29	22	1,775	0.39	15
<i>Bathylagus ochotensis</i> .....	1,301	0.36	18	2,231	0.55	15	1,078	0.22	25	1,550	0.34	16
<i>Melamphaes</i> spp.....	775	0.22	25	1,051	0.26	24	1,328	0.27	24	1,255	0.28	21
<i>Cyclothone</i> spp.....	1,532	0.43	16	814	0.20	28	2,880	0.58	13	2,795	0.62	14
<i>Tarletonbeania crenularis</i> .....	999	0.28	21	3,352	0.82	12	1,570	0.32	21	526	0.12	
<i>Argentina sialis</i> .....	832	0.23	24	1,288	0.32	22	1,400	0.28	23	276	0.06	
<i>Prionotus</i> spp.....				2,470	0.60	14	2,731	0.55	15	1,307	0.29	19
<i>Synodus</i> spp.....	641	0.18		958	0.23	25	2,338	0.47	17	1,219	0.27	23
<i>Pleuronichthys</i> spp.....	1,038	0.29	19	1,118	0.27	23	579	0.12		164	0.04	
<i>Diaphus theta</i> .....	1,022	0.28	20	3,562	0.87	11	713	0.14		588	0.13	
<i>Cynoscion</i> spp.....	860	0.24	23	104	0.02		31	0.06		1,350	0.30	18
<i>Symphurus atricauda</i> .....	73	0.02		1,373	0.34	21	1,603	0.32	20	222	0.05	
<i>Ceratoscopelus townsendi</i> .....	446	0.12		222	0.05		2,598	0.53	16	1,409	0.31	17
<i>Symbolophorus californiense</i> .....	653	0.18		462	0.11		1,645	0.33	19	1,236	0.27	22
<i>Ichthyos lockingtoni</i> .....	1,385	0.39	17	898	0.22		768	0.16		438	0.10	
<i>Palometa simillima</i> .....	933	0.26	22	611	0.15		797	0.16		114	0.02	
<i>Tetragonurus</i> spp.....	490	0.14		2,154	0.53	16	708	0.14		60	0.01	
<i>Stomias atriventer</i> .....	411	0.11		81	0.02		271	0.05		1,188	0.26	24
<i>Hygophum</i> spp.....	400	0.11		223	0.05		795	0.16		993	0.22	25
All others.....	5,808	1.62		14,652	3.60		21,023	4.26		16,280	3.58	
TOTAL.....	359,155	100.00		408,140	100.00		493,549	100.01		454,455	100.00	

\* Rank includes only first 25.

I wish to discuss the top 12 for a few moments. Larvae of the northern anchovy consistently have been the most numerous in the CalCOFI survey area; hake larvae have been consistently ranked second in abundance. Neither of these species is fished to any extent. They represent potential fishery resources. Larvae of Pacific sardine, jack mackerel, rockfish (*Sebastes* spp.) and sanddabs (*Citharichthys* spp.) are the other 4 kinds that represent present or potential commercial resources.

The six species with no foreseeable commercial importance are the gonostomatid, *Vinciguerria lucetia*, two deep sea smelts, *Leuroglossus stilbius* and *Bathylagus wesethi*, and three myctophid lantern fish, *Lampanyctus leucopsarus*, *Lampanyctus mexicanus* and *Diogenichthys laternatus*. There can be little doubt about the ecological importance of these six.

Illustrations (Figs. 1-10) are included here of the larvae of fishes making up the top 12, and of the larvae of a half-dozen other species. Species having elongated, thread-like larvae are grouped in figures 1 and 2. These all are (larvae of) isospondylous fishes. The five species illustrated, listed in their descending order in the two plates are: 1) larvae of the Pacific sardine (*Sardinops caerulea*), 2) larvae of the northern anchovy (*Engraulis mordax*), 3) larvae of the gonostomatid lantern fish, *Vinciguerria lucetia*, 4) larvae of the deep sea smelt, *Leuroglossus stilbius* and 5) larvae of another deep sea smelt, *Bathylagus wesethi*. The two tones of background shading are indicative of the depth zone in which the larvae predominantly occur. The light shading indicates distribution in the upper mixed layer, the darker shading indicates that the species occurs mostly below the thermocline. All of these species rank among the top 12 in abundance. The larvae of the two deep sea smelts have not been illustrated previously.

Our plankton hauls routinely sample the complete depth distribution of larvae of the upper mixed layer, but do not necessarily sample the complete depth distributions of the larvae that occur most commonly in and below the thermocline (dark shading). The marked decrease in abundance of *Leuroglossus* in collections made during 1958 for example, may be due in part, to less complete depth sampling during this "warm-water" year.

The larvae of 3 of the 4 species illustrated in Figures 3 and 4 are of present or potential commercial importance. These larvae as a group are deeper bodied and have larger heads than the larvae in Figures 1 and 2. The top species is a pomacentrid, the blacksmith, *Chromis punctipinnis*. The larvae of this species are moderately common, but *Chromis* does not rank among the top two dozen kinds. The larvae of the next species illustrated, Pacific mackerel, ranked between 14th and 20th in abundance during the 4-year period, 1955 to 1958. The early development of this species was described in detail by Kramer (1960). The third species in these figures, the carangid, *Trachurus symmetricus*, known commercially as the jack mackerel, is one of the abundant kinds of larvae in the CalCOFI area. The bottom illustrations are of the deeper-dwelling larvae of hake, which occur

mostly below the thermocline. The embryonic and larval development of jack mackerel was described by Ahlstrom and Ball (1954), and of hake by Ahlstrom and Counts (1955).

Larvae of seven species of myctophid lantern fishes are illustrated in Figures 5 to 7. Figures 5 and 6 illustrate larvae of the same group of species at different sizes. These are: *Lampanyctus leucopsarus*, *Lampanyctus mexicanus*, *Lampanyctus ritteri*, *Symbolophorus (Myctophum) californiense*, *Tarletonbeania crenularis*. The larvae of *Lampanyctus leucopsarus* and *L. mexicanus* are shaped rather similarly, but differ in ventral pigmentation and larger larvae of *L. mexicanus* possess a dorsal adipose spot lacking in *L. leucopsarus*. Both differ rather markedly from the larvae of *L. ritteri*, which have the deep stubby body shape that is more characteristic of the genus *Lampanyctus*. The interesting larvae of *Symbolophorus californiense* are moderately stalk-eyed, while the large larvae of *Tarletonbeania crenularis* develop an envelope-like fin fold.

Larvae of *Diogenichthys atlanticus* and *D. laternatus* are illustrated in Figure 7. Larvae of the latter species occur in abundance in the southern part of the CalCOFI area. *D. atlanticus* is only moderately common; it is distributed to the north of *D. laternatus*, with some overlap off central Baja California. These two species are very similarly pigmented but *D. atlanticus* has a barbel, making it unique in this character among myctophid larvae.

Five species of sanddabs (*Citharichthys* spp.) occur in the CalCOFI survey area. Three of the more common species are shown in Figures 8 and 9. The more northerly distributed sanddabs are *Citharichthys stigmaeus* (upper) and *C. sordidus* (middle). *C. xanthostigma* larvae occur in abundance off central Baja California. In bothid flatfish it is usual to have one or more anterior dorsal and pelvic rays elongated. Note that larger larvae of *C. sordidus* and *C. xanthostigma* have two elongated anterior dorsal rays (actually the 2nd and 3rd anterior rays) and two correspondingly elongated pelvic rays. The other 2 species of *Citharichthys* in the CalCOFI area, *C. fragilis* and *C. gilberti* also possess this larval character. Hence *C. stigmaeus* is the more unusual in lacking such elongated rays at all larval sizes. It also develops much less pigmentation than any of the other species of *Citharichthys*.

Larvae of rockfish (*Sebastes* spp.) are illustrated in Figure 10. *Sebastes* contains many more species than any other genus in the eastern Pacific, over 50 in California waters. Because of this complexity, very few larval series have been established as yet for individual species. An exception is *Sebastes paucispinis*, whose larvae are figured in the lower half of this plate. This species develops elongated pectoral and pelvic fins, which are rather heavily pigmented near their tips. The paired occipital spines, on the back of the head, sometimes bifurcate, are characteristic of rockfish larvae.

Another aspect of egg and larval surveys that is of prime importance in resource evaluation is the information obtained on distribution. Before Cal-

COFI little was known about the distribution of jack mackerel, for example. The CalCOFI surveys soon showed that jack mackerel eggs and larvae occurred throughout the CalCOFI area. Larvae were taken as far seaward as the cruises extended. On Norpac, jack mackerel eggs and larvae were taken 1100 miles at sea off Washington. There seems little doubt that jack mackerel is an oceanwide resource in the temperate north Pacific.

The southward extent of the distribution of jack mackerel eggs and larvae is adequately delimited by our cruises but not the offshore or northward extents. The southern boundary shifts in response to changing oceanographic conditions, as is illustrated by the more southward extent of jack mackerel larvae in 1954 (Fig. 11B) as co-mapped to 1958 (Fig. 11A).

Hake furnishes another example. Hake larvae consistently have been the second most abundant kind in CalCOFI collections, exceeded only by anchovy larvae. Hake eggs and larvae are almost as widespread in the CalCOFI survey area as jack mackerel (Fig. 11C). Adult hake apparently move offshore to spawn, and return to the area of the continental slope after spawning.

Distribution of larvae of rockfish (Fig. 12B) and sanddabs (Fig. 12C) represent the composite distributions of a number of species; 5 in *Citharichthys*, up to 50 in *Sebastes*. Both genera have a greater offshore extent than is anticipated for near bottom dwelling fishes. This offshore distribution is a consistent phenomenon, occurring in all years covered by our investigations.

Species with tropical-subtropical distribution extend varying distances to the north depending in part on the species, in part on hydrographic conditions. *Vinciguerria lucetia*, perhaps the most abundant fish larvae in the tropical eastern Pacific, is distributed as far north as Point Conception, California in most years (Ahlstrom and Counts 1958, Figs. 18 and 19) and off central California in favorable seasons (Fig. 12A). The distribution of this species in the CalCOFI area constitutes but a fraction of its distribution in the eastern Pacific (Ahlstrom and Counts 1958 Fig. 21).

Another abundant tropical-subtropical species with an equally extensive distribution is *Diogenichthys laternatus* (Fig. 13A). On Shellback Expedition, larvae of this species were by far the most abundant myctophid larvae in the eastern tropical Pacific. In most years this species extends as far north as off Pt. San Eugenio, central Baja California, but in favorable (warmer) years it can reach southern California. Hence the distribution of this species in the CalCOFI area constitutes only the northern portion of extensive range. The area of distribution of *D. atlanticus* is in offshore oceanic waters off central and southern Baja California and in the portion of the CalCOFI area lying between Pt. San Eugenio and San Francisco, California. It is a much less abundant species than its close relative (Fig. 13B).

Two myctophids having subarctic-temperate distributions are *Tarletonbenia crenularis* (Fig. 13C) and *Lampanyctus leucopsarus* (Fig. 14C). Larvae of such

temperate water species occur in greatest abundance during the colder season of the year—winter and spring; larvae of the subtropical myctophid, *Lampanyctus mexicanus* (Fig. 14B) are rare in winter collections, and build to a peak during the summer cruises. The distribution of this species is more restricted than that of many other myctophids, hence the area shown probably constitutes a larger portion of the total distribution of this species in the eastern north Pacific exclusive of the Gulf of California than for such species as *Lampanyctus ritteri* (Fig. 14A) or *Lampanyctus regalis* (distribution not illustrated). Within its area of occurrence, however, it is probably the most abundant myctophid present.

The most abundant of the deep sea smelts is *Leuroglossus stilbius*. It is as widely distributed in the CalCOFI area as jack mackerel or hake (Fig. 15C). Furthermore it is widely distributed in the Gulf of California, and as a matter of interest was initially described from Gulf material. Incidentally in some groups of fishes the differences between larvae of the several species are more striking than differences between adult fishes. The deep sea smelts are one such group. Although larvae of *Bathylagus wesethi* are abundant enough to put it among the top 12, it has a somewhat circumscribed distribution (Fig. 15A) being replaced in the north by *Bathylagus ochotensis* and to the south by *Bathylagus nigrigenys*. The distribution of *B. ochotensis* is shown in Figure 15B. This species is very widely distributed in the north Pacific in subarctic to temperate waters. Some of this wider distribution is shown in Figure 16. This figure summarizes the distribution of bathylagid and argentinid fishes in the part of Norpac that was covered by CalCOFI vessels in August 1955. Note the offshore occurrences of *Bathylagus ochotensis* and the more circumscribed distribution of *B. wesethi*. *Leuroglossus* is principally a winter and spring spawner and this is undoubtedly why there are so few occurrences during Norpac which was made during August.

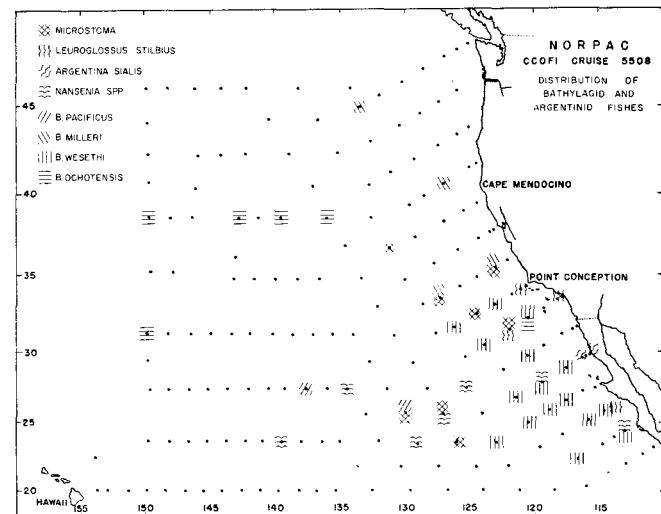

FIGURE 16. Distribution of larvae of Bathylagids and Argentinids on Norpac.

We obtained such excellent information on distributions of fish larvae on Norpac, that I consider this the most important survey made during the history of CalCOFI. Despite its value, it so far has been only a one-time thing. There is nothing I would like better than to see Norpac repeated at the other seasons of the year, especially in February–March when hake spawning is at its peak, and in May–June when jack mackerel spawning is at its peak.

As I mentioned at the beginning of my presentation, the sardine has been the pivotal species in our studies. We have circumscribed its spawning distribution and in doing this have largely circumscribed the spawning distributions of other important wet-fishes, including the anchovy and the Pacific mackerel.

One of the important things that we have learned about the distribution of fish at spawning is that it varies from season to season. There is no such thing as fixed spawning areas for pelagic fish in the California Current system. The only way to outguess the fish is to sample so widely that you are bound to fence them in. The marked differences in spawning distribution that can occur in adjacent years is most strikingly shown by the spawning distribution of sardines in 1953 and 1954 (for distributional charts refer to Ahlstrom, 1959). In 1953, sardine spawning was mainly restricted to central Baja California, with only about 1% occurring off California. In 1954 the fish reinvaded California in numbers, having a very widespread spawning distribution. The 1954 spawning has an areal extent that is nearly 2½ times as great as spawning distribution in 1953.

In such years as 1954 and 1955, sardine spawning was more widely distributed off southern California than anchovy, especially in offshore water. There was a zone offshore in which sardine larvae occurred alone. The pattern was repeated in several years, and I began to consider it characteristic of sardines to move fairly far offshore to spawn. Anchovies didn't appear to be so venturesome.

In recent years, larval abundance of anchovies has continued to increase. Anchovy larvae, instead of being only 3.3 times as numerous as sardine larvae in 1951 became over 9 times by 1955 and nearly 24 times by 1958. Since then the disproportion has further increased until it was approximately 80 to 1 in 1962, as determined from the four quarterly cruises made in that year.

With the changes in abundance, the spawning distribution of the 2 species markedly altered. The moderate sardine spawning remaining is concentrated inshore. Anchovy larvae are now abundant in the offshore waters of southern California, as well as in inshore waters. In fact they seem to be everywhere. Anchovy larvae co-occur in nearly all hauls containing sardine larvae—94% of the hauls in 1958, 98% in 1962. There were 6 anchovy larvae for each sardine in co-occurrence hauls in 1962.

It is because of the information gained on egg and larval surveys that we have been able to document the increase in the anchovy population. The anchovy is but little fished commercially; only 1382 tons were landed in 1962 and another 6000 or 7000 tons

were used for bait by sportfishermen. Hence the fishery yields little information on the state of the anchovy resource.

The numbers of anchovy larvae that were taken on CalCOFI surveys during 1952 through 1959 are given in Table 2.

TABLE 2  
ABUNDANCE OF ANCHOVY LARVAE

	<i>Census estimates</i> × 10 <sup>8</sup>
1951-----	15,100
1952-----	17,070
1953-----	23,680
1954-----	38,410
1955-----	37,660
1956-----	38,510
1957-----	40,440
1958-----	56,930
1959-----	54,170

I am using estimates that take unequal spacing of stations into account; and designate them as "census estimates".

The anchovy population more than doubled in size between 1951 and 1954 and trebled in size by 1958. The anchovy population is even larger in 1962 and 1963. We presently are conducting only quarterly surveys, but on these anchovy larvae are as numerous as all other fish larvae combined. We have been impressed by the consistency of our anchovy data.

	<i>No. hauls</i> <i>taken</i>	<i>Occurrences</i> <i>of anchovy</i>	<i>Ave. no.</i> <i>per haul</i>	<i>Ave. no. per</i> <i>positive haul</i>
1954-----	1474	758	109	213
1955-----	1375	616	102	218
1956-----	1397	536	97	252
1957-----	1493	580	98	253
1958-----	1853	778	111	264

For example, between 1954 and 1958 the average number of anchovy larvae per haul made in the CalCOFI area, was 109 in 1954, 102 in 1955, 97 in 1956, 98 in 1957 and 111 in 1958, a range from 97 to 111. The figures are based on all hauls taken, whether anchovy larvae were present or not. When only positive hauls are considered, the average number per haul increased somewhat between 1954 and 1958. In 1954 it was 213 larvae, then in succeeding years 218, 252, 253 and 264—15% more larvae were taken per positive haul in 1958 than in 1954.

One reason for the consistency in the above figures is that we sample about the same proportion of large concentrations of anchovy larvae, moderate concentrations, etc., during each season. During 1954–1958, the proportion of hauls containing few to many larvae were as follows:

- Hauls containing 1 to 10 larvae: 24 to 29% of positive hauls
- Hauls containing 11 to 100 larvae: 30 to 42% of positive hauls
- Hauls containing 101 to 1000 larvae: 25 to 33% of positive hauls
- Hauls containing over 1000 larvae: 5.5 to 7.5% of positive hauls

We report on the size composition of anchovy larval samples. For ready comparison the larvae are grouped by about 3 mm intervals:

	Percent of seasonal total in size categories				
	1954	1955	1956	1957	1958
2.50- 5.75-----	60.3	60.3	48.4	55.8	62.3
6.75- 8.75-----	28.1	27.2	32.7	29.8	25.6
9.75-11.75-----	8.8	9.7	15.4	11.5	9.1
12.75-14.75-----	2.14	2.01	2.77	2.28	2.26
15.75 & larger---	0.57	0.68	0.64	0.62	0.66

There were about the same proportion of larvae of different sizes during the five years. This as a gratifying result, for if the proportion of larvae of different sizes is about constant, then estimates based on total number of larvae are quite meaningful.

But there is one aspect of the above that isn't as gratifying. We had hoped to be able to distinguish between good and poor year classes of fishes by differences in survival of larvae. The survival curves for anchovy larvae are surprisingly similar from year to year. This uniformity can be seen by looking at the proportion of larger larvae that were present in the 1954-1958 samples. Larvae 15.75 mm and larger constituted 0.57% of the total in 1954, 0.68% in 1955,

0.64% in 1956, 0.62% in 1957, 0.66% in 1958. A similar uniformity is found in our sardine larval summaries. I am just pointing this fact up, not trying to develop it here. It is a problem that will have to be dealt with separately.

## REFERENCES

- Ahlstrom, E. H., 1959. Distribution and abundance of eggs of the Pacific sardine, 1952-1956. *U.S. Fish and Wild. Serv., Fish. Bull.*, 60 (165) : 185-213.
- Ahlstrom, E. H., and O. P. Ball, 1954. Description of eggs and larvae of jack mackerel (*Trachurus symmetricus*) and distribution and abundance of larvae in 1950 and 1951. *U.S. Fish and Wild. Serv., Fish. Bull.*, 56 (97) : 209-245.
- Ahlstrom, E. H., and R. C. Counts, 1955. Eggs and larvae of the Pacific hake, *Merluccius productus*. *U.S. Fish and Wild. Serv., Fish. Bull.*, 56 (99) : 295-329.
- Ahlstrom, E. H., and R. C. Counts, 1958. Development and distribution of *Vinciguerria lucetia* and related species in the Eastern Pacific. *U.S. Fish and Wild. Serv., Fish. Bull.*, 58 (139) : 363-416.
- Ahlstrom, E. H., J. D. Isaacs, J. R. Thraikill and L. W. Kidd, 1958. A high-speed plankton sampler. *U.S. Fish and Wild. Serv., Fish. Bull.*, 58 (132) : 187-214.
- Kramer, D., 1960. Development of eggs and larvae of Pacific mackerel and distribution and abundance of larvae 1952-56. *U.S. Fish and Wild. Serv., Fish. Bull.*, 60 (174) : 393-438.

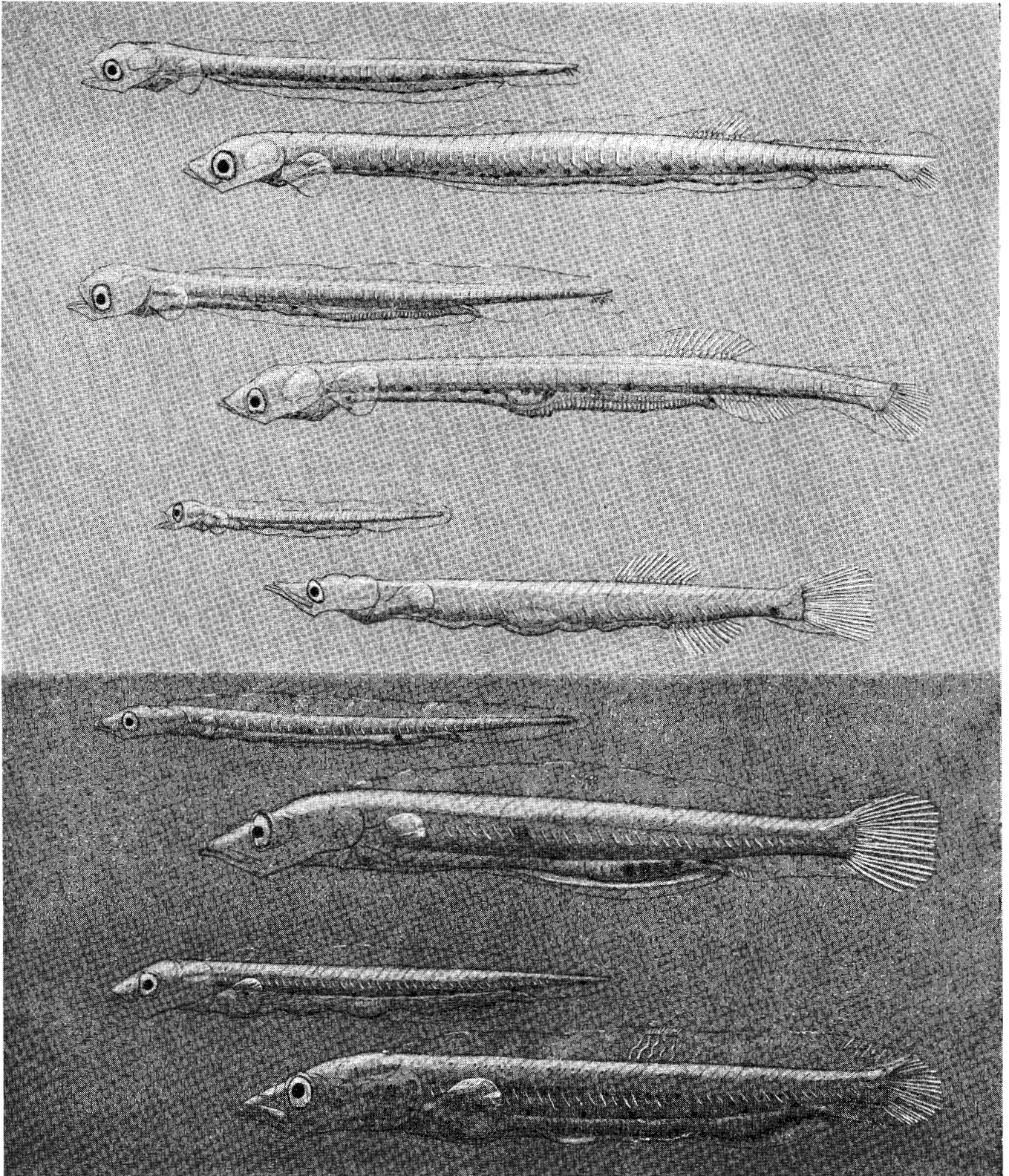

FIGURE 1. From top to bottom—*Sardinops caerulea* 5.6mm–12.5mm; *Engraulis mordax* 6.0mm–11.5mm; *Vinciguerria lucetia* 3.2mm–9.0mm; *Leuroglossus stilbius* 5.4mm–15.7mm and *Bathylagus wesethi* 5.7mm–11.3mm.

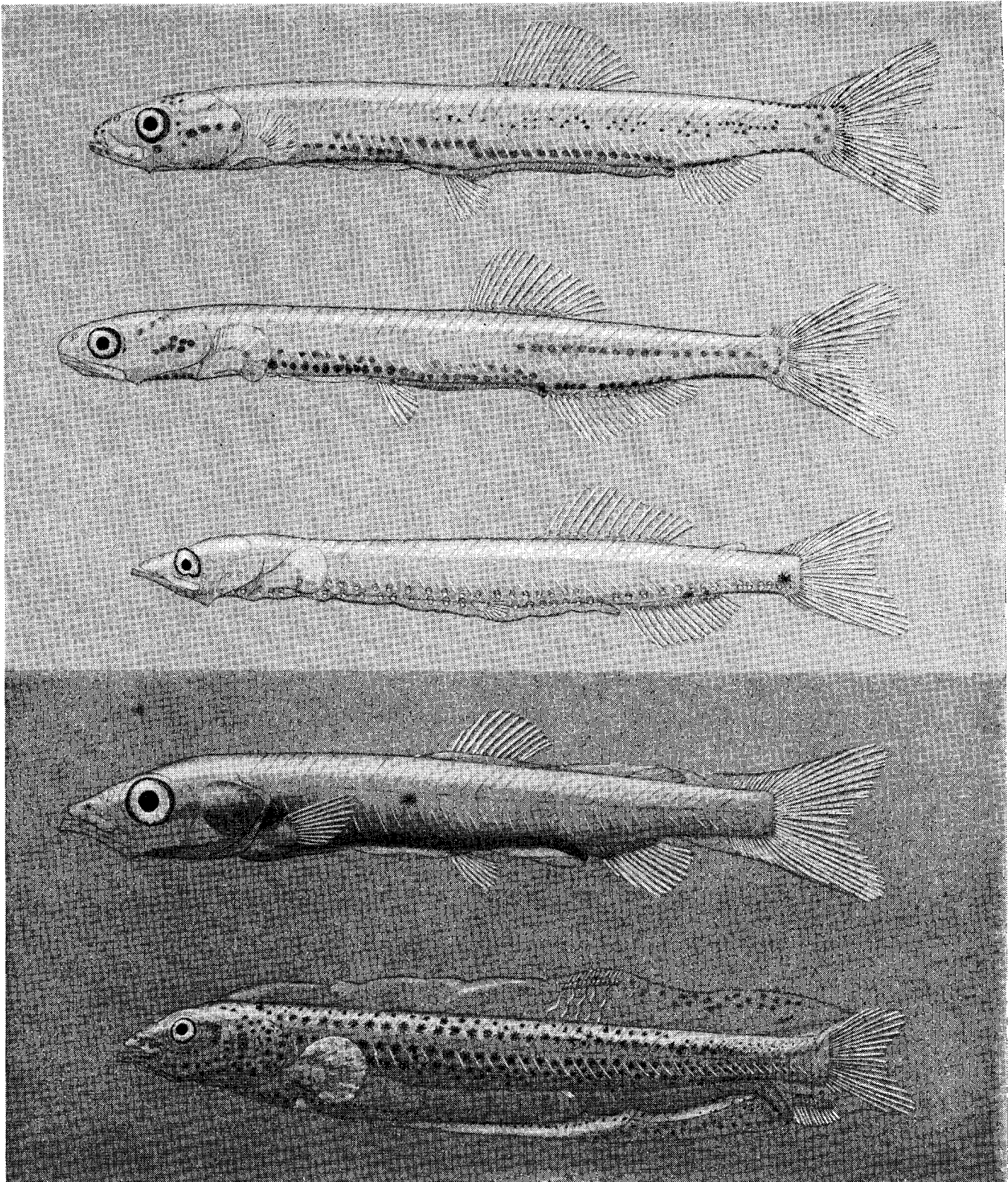

FIGURE 2. From top to bottom—*Sardinops caerulea* 31.3mm; *Engraulis mordax* 31.0mm; *Vinciguerria lucetia* 15.0mm; *Leuroglossus stilbius* 28.5mm and *Bathylagus wesethi* 24.5mm.

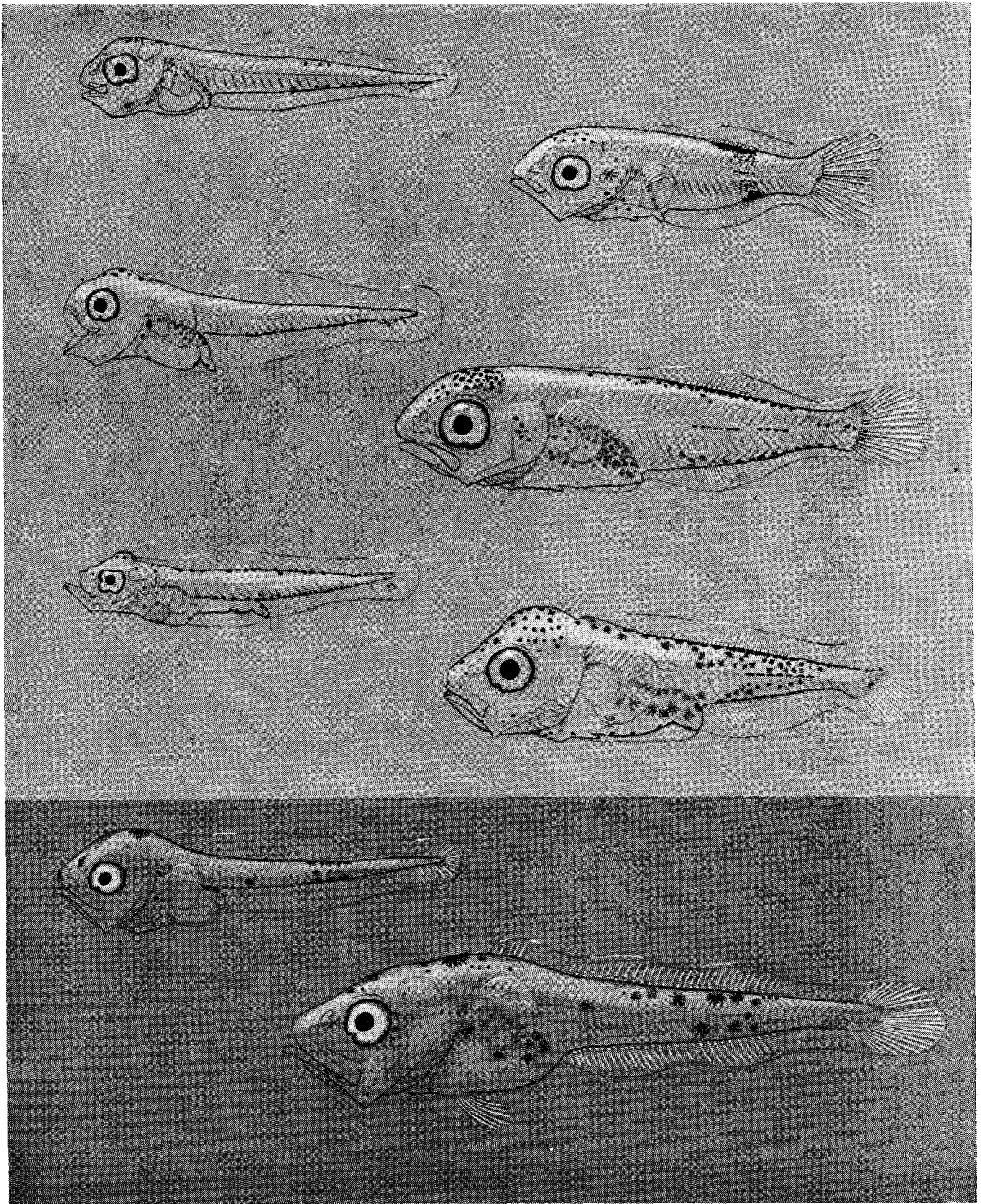

FIGURE 3. From top to bottom—*Chromis punctipinnis* 4.25mm–5.5mm; *Pneumatophorus diego* 4.0mm–7.8mm; *Trachurus symmetricus* 3.5mm–7.4mm and *Merluccius productus* 4.3mm–10.11mm.



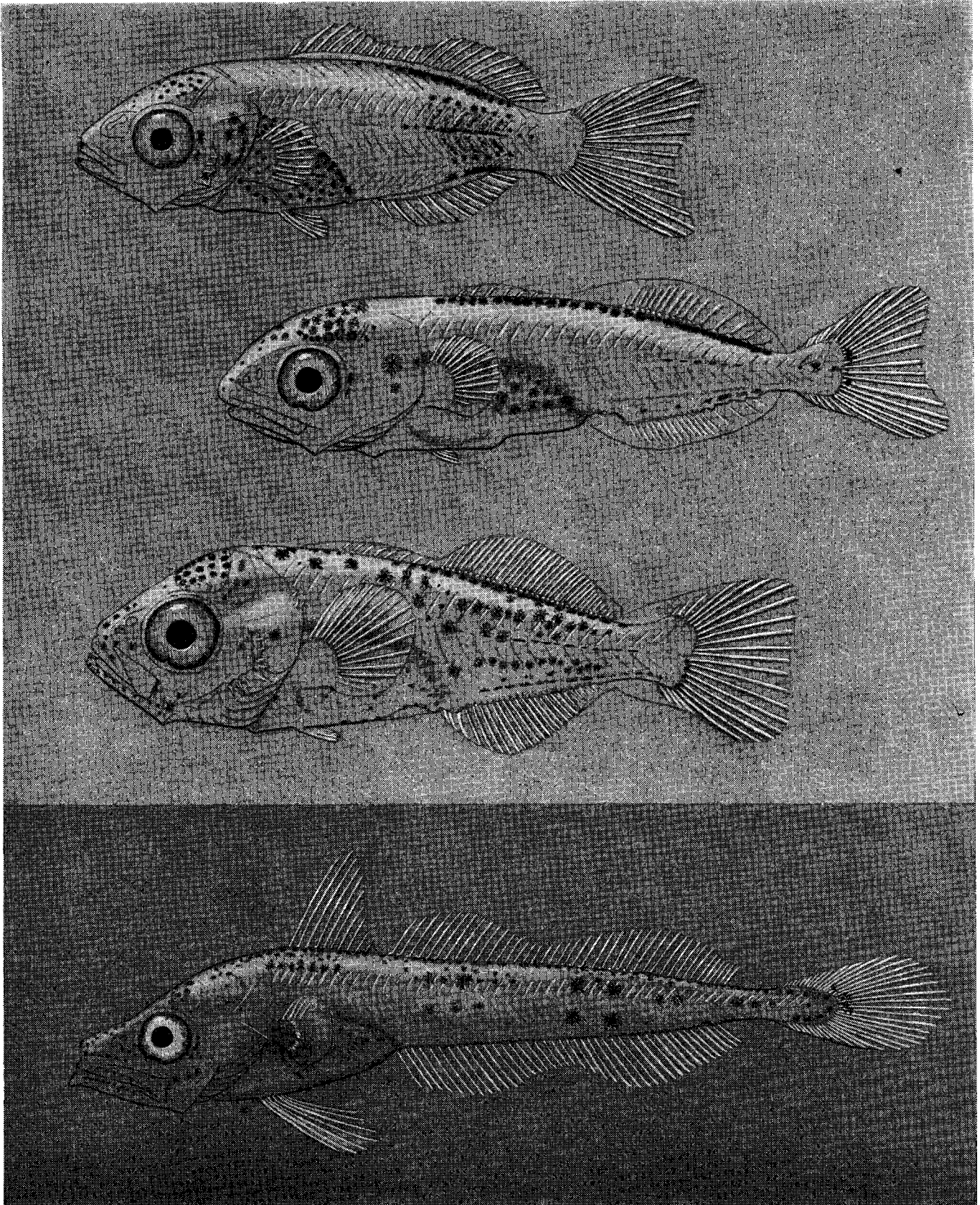

FIGURE 4. From top to bottom—*Chromis punctipinnis* 8.5mm; *Pneumatophorus diego* 10.1mm; *Trachurus symmetricus* 10.0mm and *Merluccius productus* 20.0mm.

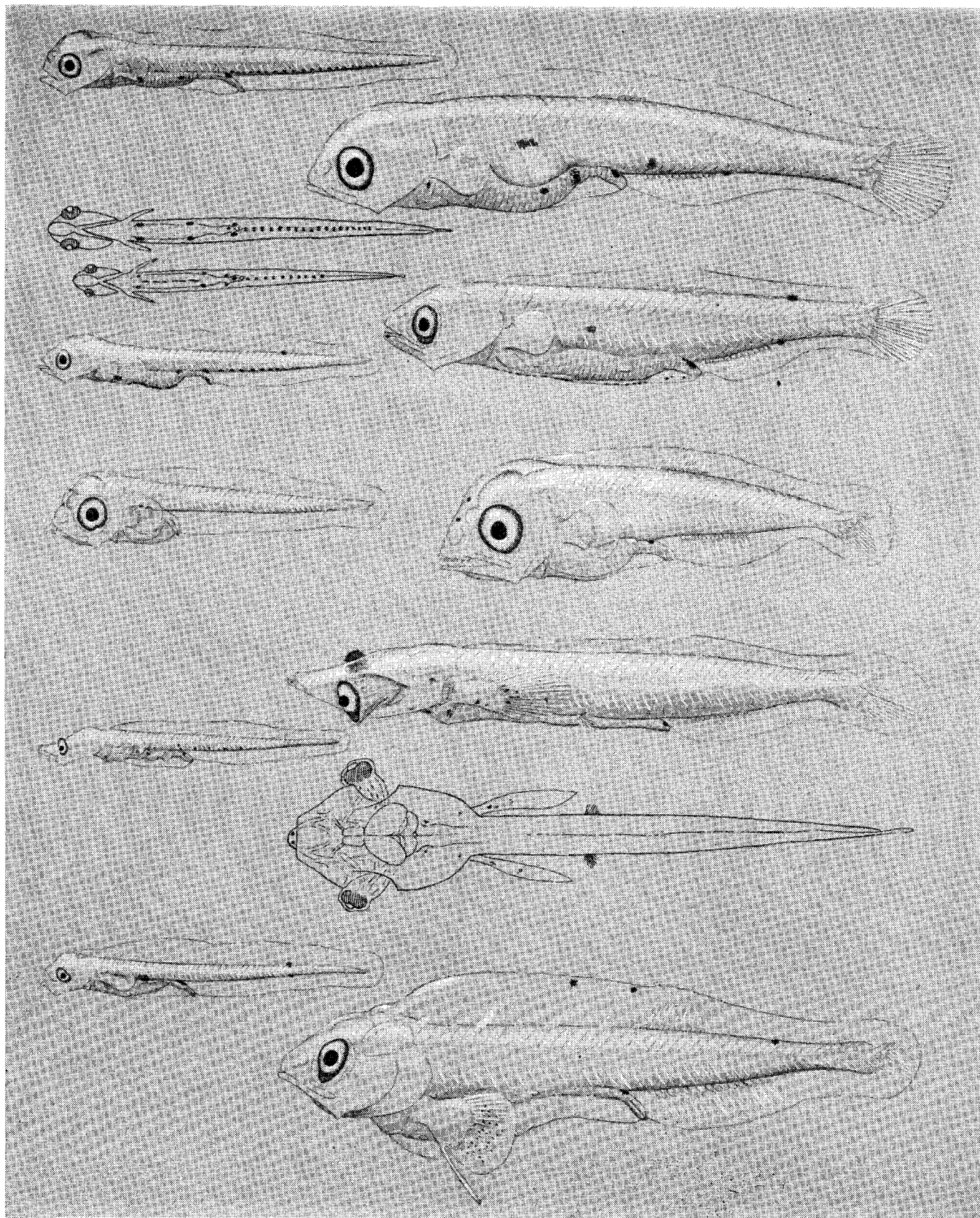

FIGURE 5. From top to bottom—*Lampanyctus leucopsarus* 5.3mm–7.8mm; *Lampanyctus mexicanus* 4.4mm–6.75mm; *Lampanyctus ritteri* 4.3mm–5.75mm; *Symbolophorus californiense* 4.0mm–8.0mm and *Tarletonbeania crenularis* 4.2mm–7.8mm.

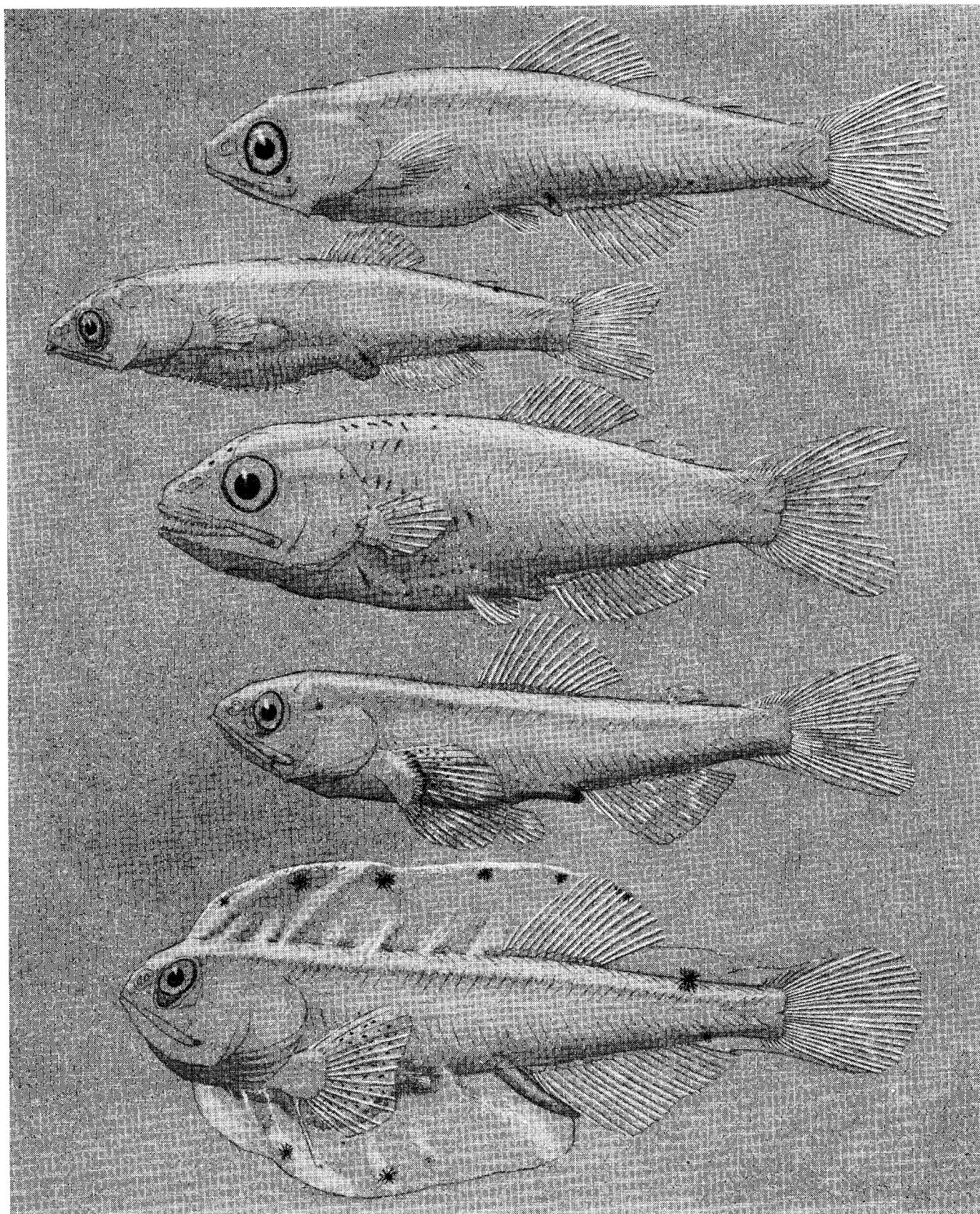

FIGURE 6. From top to bottom—*Lampanyctus leucopsarus* 12.5mm; *Lampanyctus mexicanus* 10.5mm; *Lampanyctus ritteri* 12.5mm; *Symbolophorus californiense* 23.0mm and *Tarletonbeania crenularis* 17.8mm.

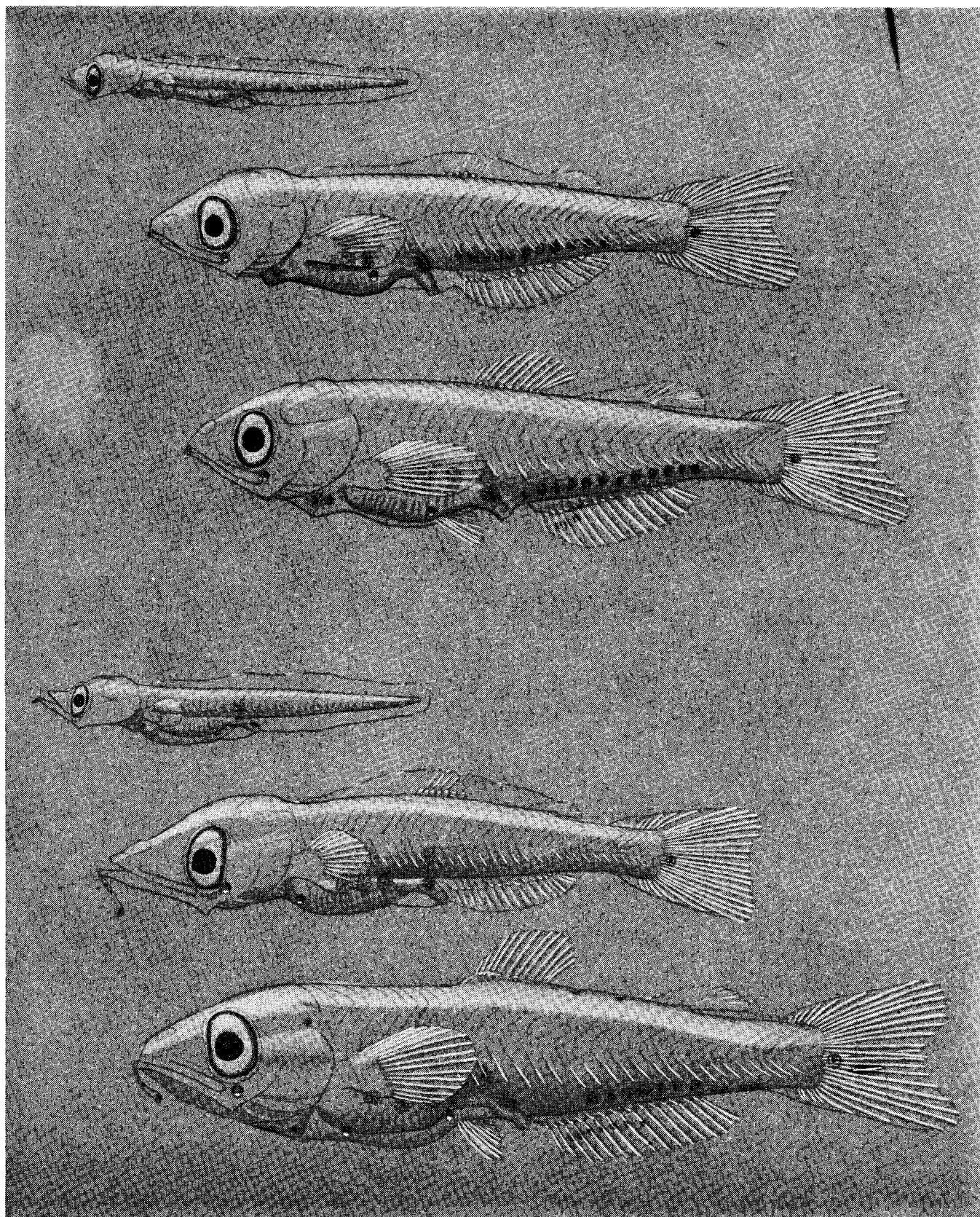

FIGURE 7. From top to bottom—*Diogenichthys laternatus* 3.7mm–7.0mm–9.75mm and *Diogenichthys atlanticus* 4.0mm–6.0mm–11.25mm.

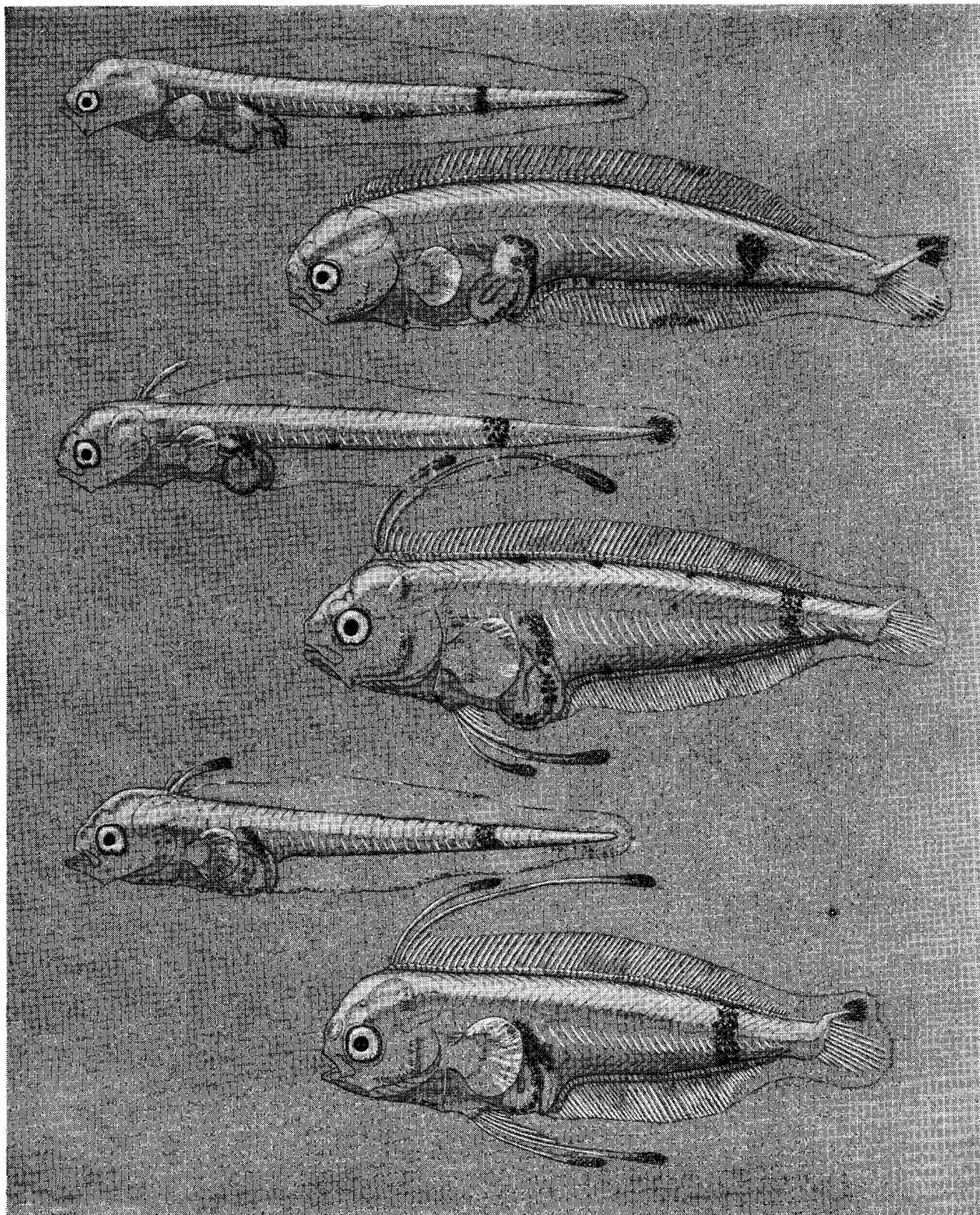

FIGURE 8. From top to bottom—*Citharichthys stigmaeus* 6.5mm–10mm; *Citharichthys sordidus* 6.9mm–10mm and *Citharichthys xanthostigma* 6.2mm–9mm.

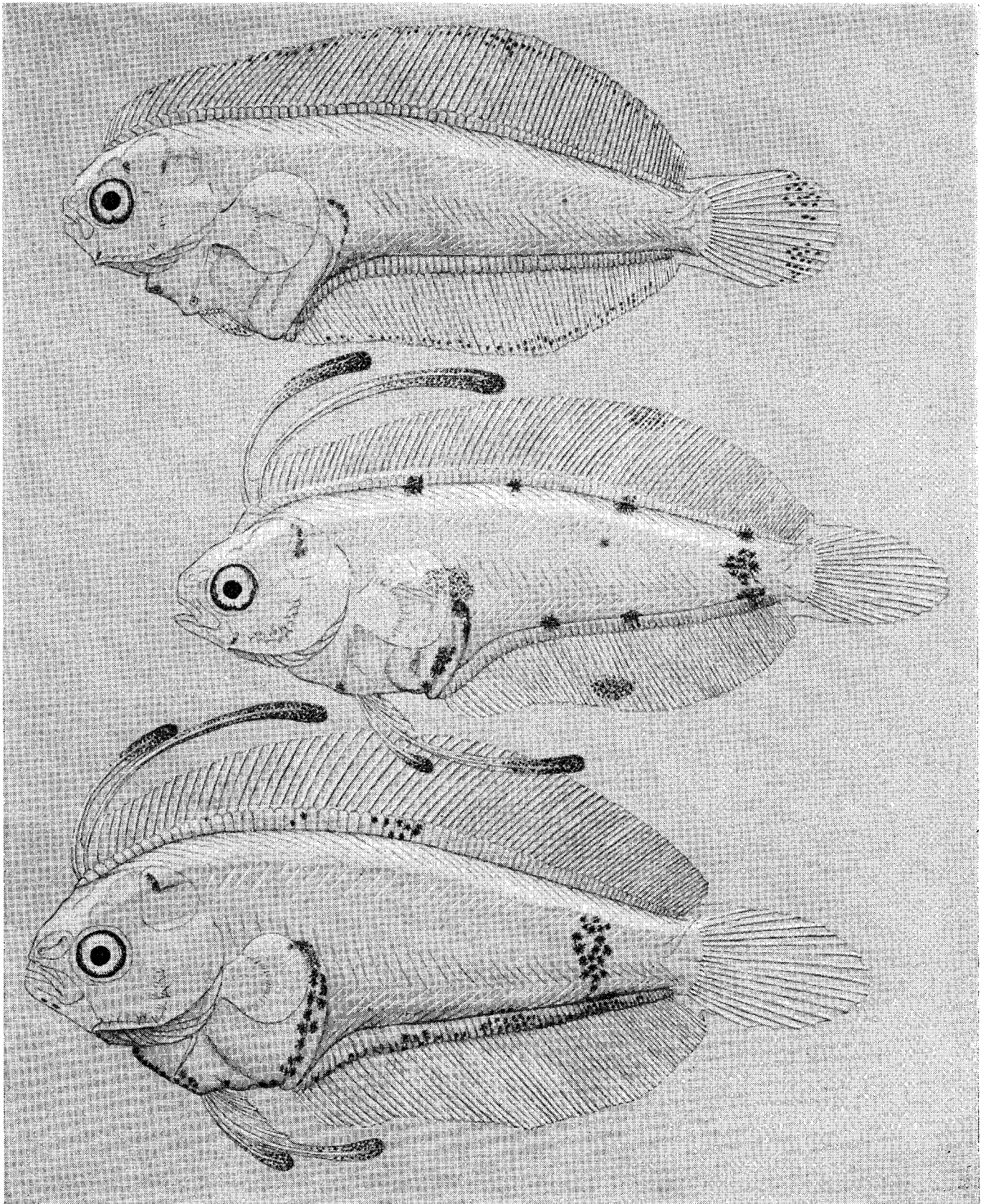

FIGURE 9. From top to bottom—*Citharichthys stigmaeus* 14.75mm; *Citharichthys sordidus* 14.5mm; and *Citharichthys xanthostigma* 15.3mm.

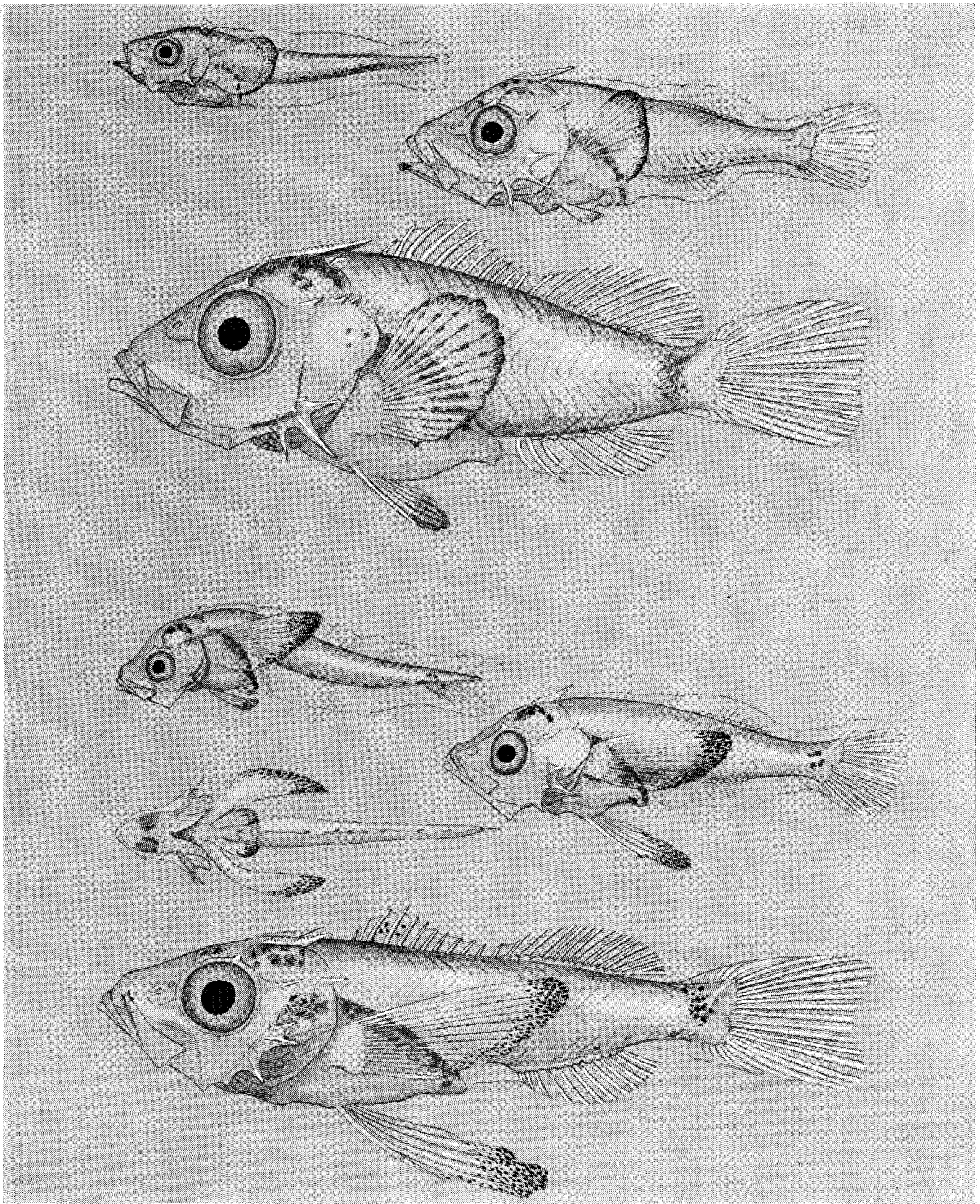

FIGURE 10. From top to bottom—*Sebastodes* species 6.0mm, 7.8mm, 12.7mm, 6.8, 8.0mm , 6.8mm, and 11.9mm.

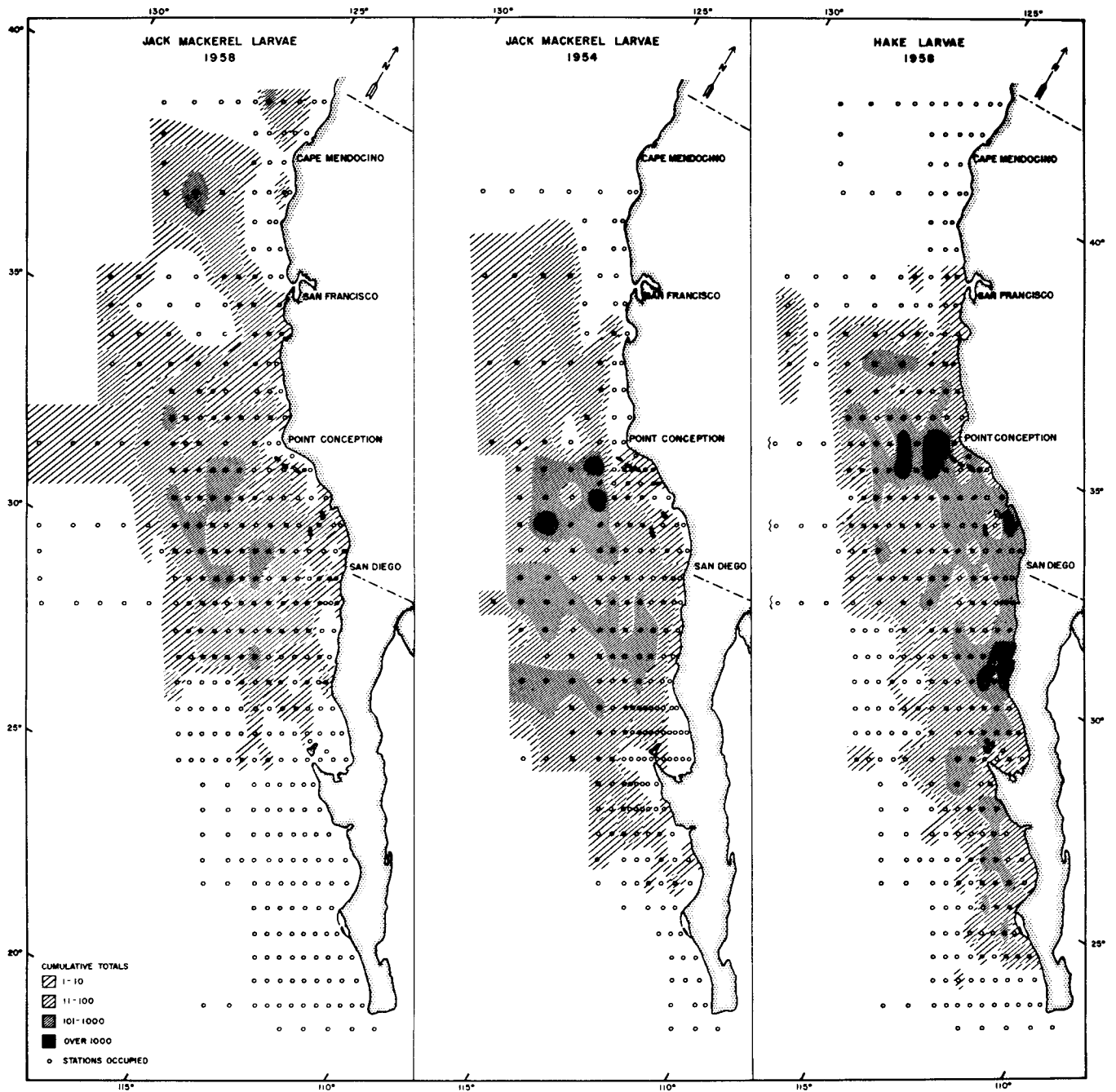

FIGURE 11. Distribution and relative abundance of Jack mackerel larvae, A: 1958; B: 1954; C: Hake larvae, 1958.



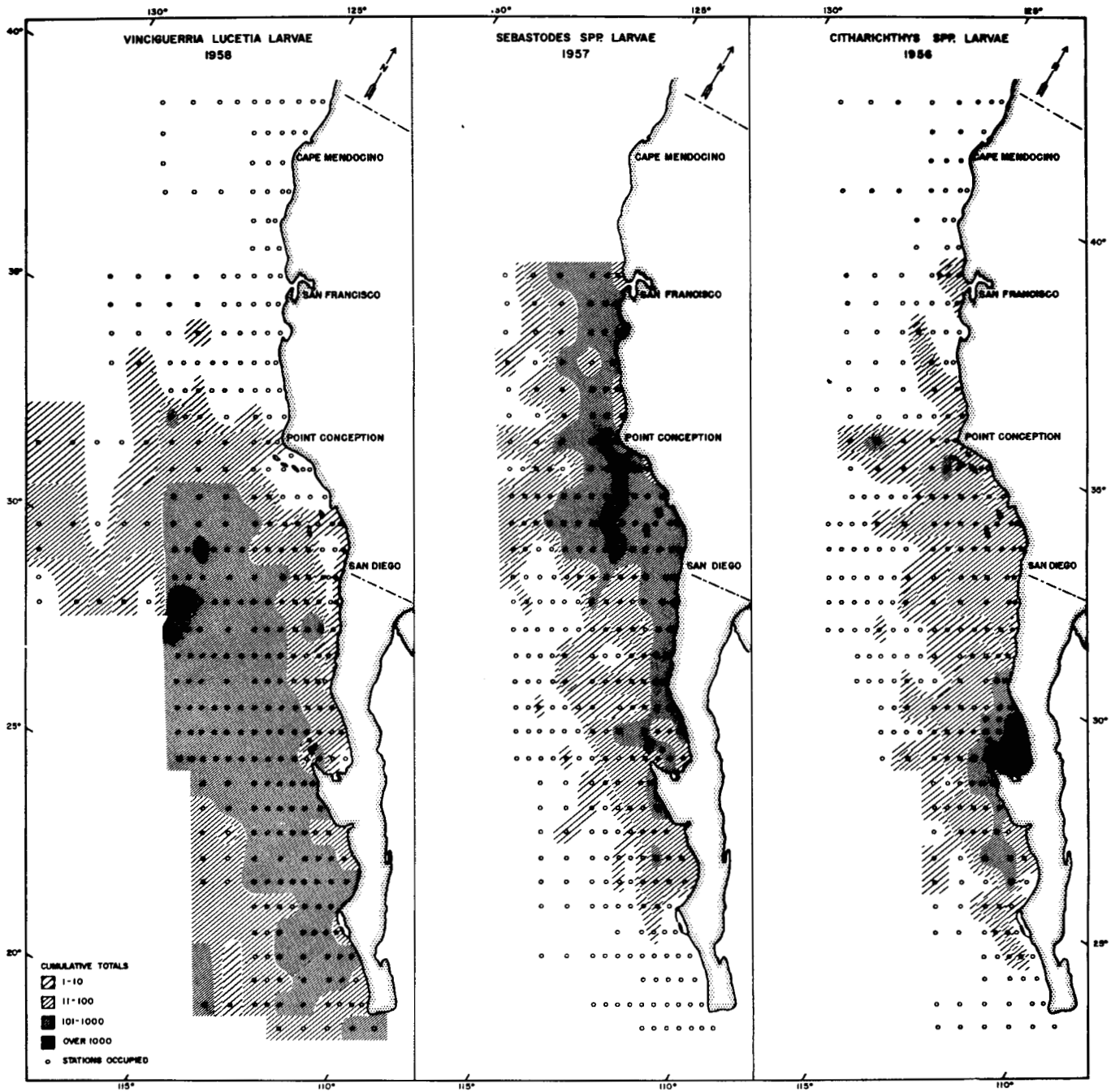

FIGURE 12. Distribution and relative abundance of *Vinciguerria lucetia* larvae, A: 1958; B: *Sebastodes* spp. larvae, 1957; C: *Citharichthys* spp. larvae, 1956.

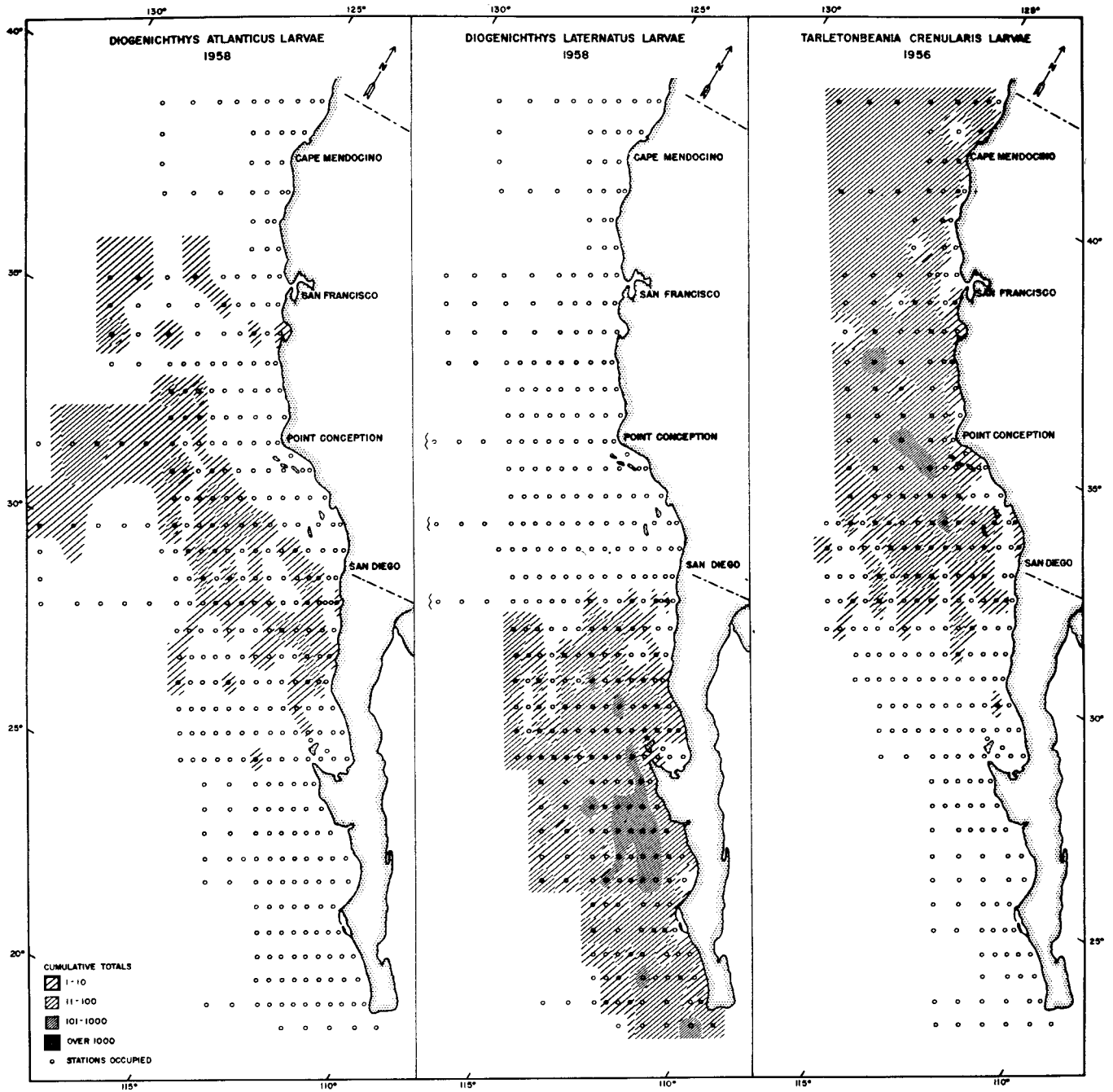

FIGURE 13. Distribution and relative abundance of *Diogenichthys atlanticus* larvae, A: 1958; *Diogenichthys laternatus* larvae, 1958; C: *Tarletonbeania crenularis* larvae, 1956.

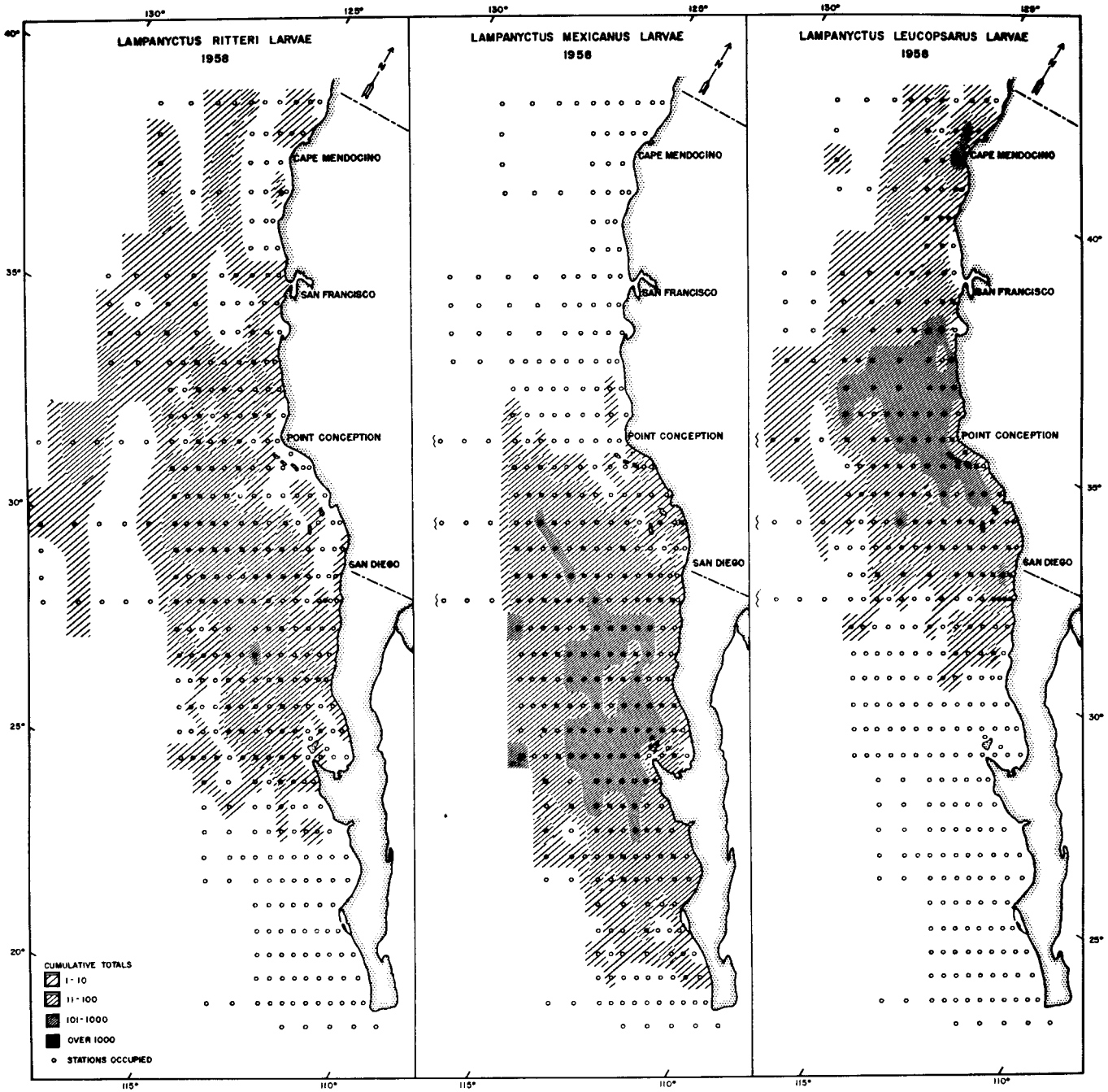

FIGURE 14. Distribution and relative abundance of *Lampanyctus ritteri* larvae, A: 1958; B: *Lampanyctus mexicanus* larvae, 1958; C: *Lampanyctus leucopsarus* larvae, 1958.

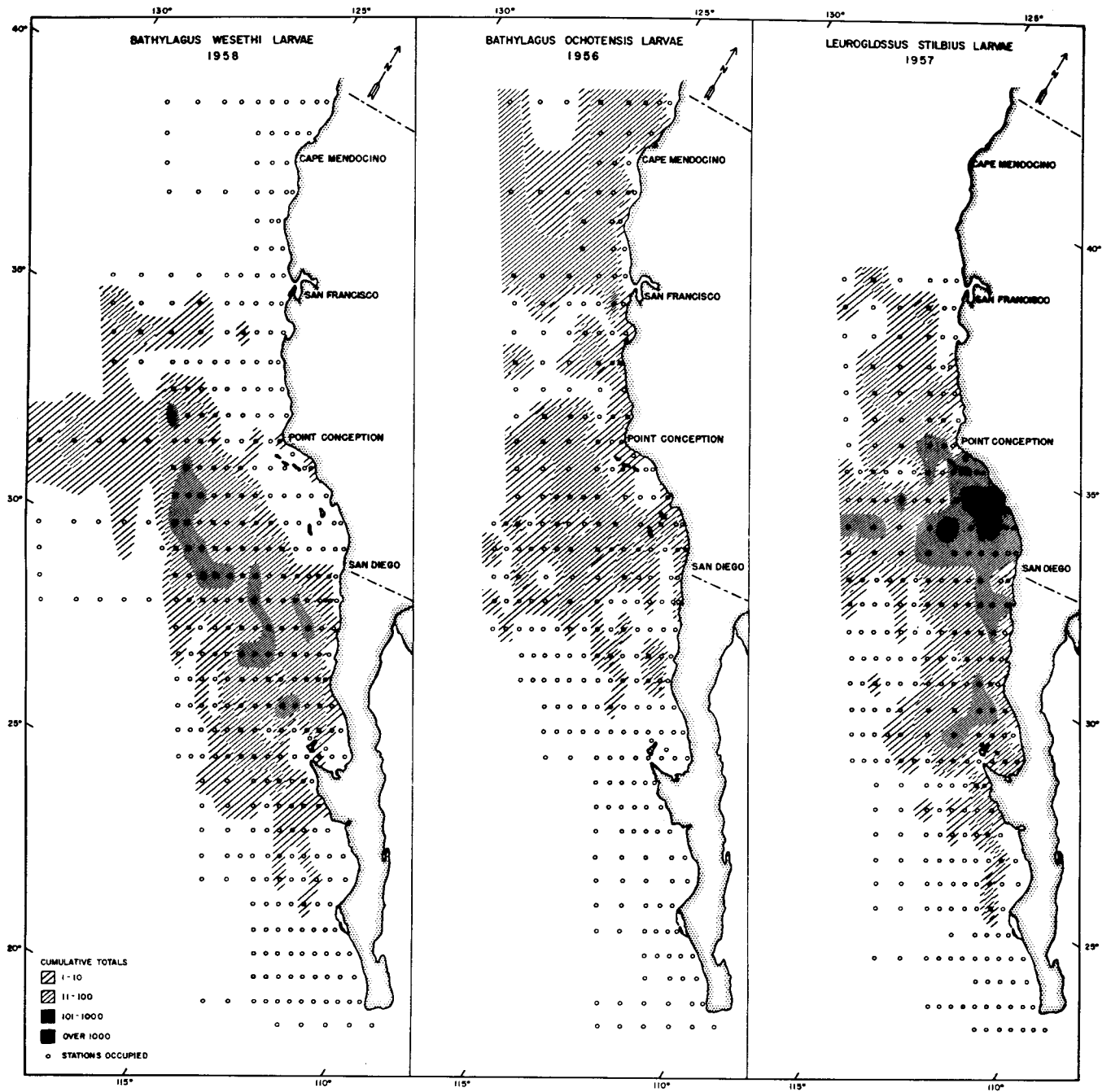

FIGURE 15. Distribution and relative abundance of *Bathylagus wesethi* larvae, A: 1958; B: *Bathylagus ochotensis* larvae, 1956; C: *Leuroglossus stilbius* larvae, 1957.

# REARING MARINE FISH FOR COMMERCIAL PURPOSES

JAMES E. SHELBOURNE

Fisheries Laboratory, Lowestoft, England

How do we counteract the depletion of a fishery, due to intensely competitive fishing, without unbalancing the industry? This conservation problem has pre-occupied fishery science for several decades, but internationally acceptable solutions are difficult to achieve. It is not an easy matter for nations with diverse gear, ships and market requirements, to reach agreement on hunting procedures. Ironically enough, when man's hunting instincts become in-turned upon himself, then stock depletion in our seas begins to appear less of a problem. Fishing restrictions in the North Sea during the two world wars led to striking increases in the abundance of plaice (*Pleuronectes platessa*), without undue effects on growth rate (Borley, 1923; Margetts and Holt, 1948). We can assume, therefore, that when over-fishing prevails, the food biomass available to fish is not fully exploited. More "mouths" are needed to utilize this wastage.

## THE MARINE FISH HATCHERY MOVEMENT

The idea that artificial propagation could influence the yield from inshore waters originated in the New World, and was the consequence of achievements in fresh-water fish rearing. Remarkable progress in culturing and transplanting the shad (*Alosa sapidissima*), undoubtedly influenced the first U.S. Commissioner of Fisheries (Spencer F. Baird) in his decision to try artificial propagation as a possible means of counteracting depletion in the food-fisheries of the Atlantic seaboard.

Earll (1880) reported the successful hatching of cod, haddock, herring and pollock eggs during preliminary experiments at Gloucester, Massachusetts, in 1878. It was not until 1885 that the U.S. Fish Commission built its first commercial fish hatchery at Woods Hole. Facilities for cod propagation were extended at Gloucester Station in 1888, followed by the construction of a third east coast hatchery at Boothbay Harbor, Maine in 1905.

The Norwegians were equally interested in artificial propagation as a palliative measure. Capt. G. M. Dannevig started a cod-hatching program in 1884 at Flødevigen, on the Skagerrak coast, financed from joint private and public funds. A second hatchery devoted to propagation of the plaice was erected at Trondhjemsfjord in 1908.

The British effort was centered around three establishments for hatching flatfish—one at Dunbar, Scotland, built in 1893 and later removed to the Bay of Nigg, Aberdeen—the other two on the Irish Sea coast, at Piel Lancashire (1897), and Port Erin, Isle of Man (1902).

Between 1890 and 1901, the Newfoundland Department of Fisheries operated a cod hatchery on Dildo Island. The movement spread as far as Gunnamatta Bay, Australia, and Dunedin, New Zealand, where hatcheries were built to propagate imported flatfish (Dannevig, 1908).

The early years of the 20th century were the 'golden' era of the marine fish hatchery movement. Commercial establishments sprang up all over the world, unhindered by the severe criticism later to be levelled at the basic concepts of hatchery practice. By 1917, the total output of newly-hatched fry from the three American hatcheries had risen to over 3 billion per annum. This greatly exceeded the aggregate annual output of the European system, in its most productive years before the first world war. When hostilities ceased, the European movement was, in fact, already declining, but the American effort continued at a high level of production until 1943, when Woods Hole was taken over by the Navy Department. The Boothbay Harbor hatchery closed down in 1950, followed by Gloucester Station in 1952. The demise of American sea-fish culture was accompanied by the following terse official statement . . . "Hatchery production of marine commercial fish species was terminated in 1952 since research had failed to disclose that worthwhile benefits were obtained from such stocking." (Duncan and Meehan, 1954).

## THE TECHNIQUE AND PRACTICAL VALUE OF MARINE FISH HATCHING

The pioneers of sea-fish hatching embraced the fallacious hypothesis that the brood strength of any species entering a fishery is directly proportional to the number of eggs spawned by the adult stock. They were therefore very concerned at the loss of spawn due to the commercial fishing of spawning aggregations. Salvaged eggs could be artificially fertilized; it seemed a logical step to provide hatchery protection during the period of egg incubation.

American and European techniques differed in several respects. The Americans preferred to rely on salvaged spawn, particularly at Gloucester and Boothbay Harbor. 'Spawn-takers', operating from New England fishing vessels, selected ripe fish from the catch, and carried out artificial fertilizations using a standard technique. Fertile eggs were transported to the nearest hatchery by first train after the ship docked. At Woods Hole, hand-lined cod were also kept in floating boxes until ripe, and then stripped, at intervals of a few days, until the ovaries became completely discharged. At Flødevigen, Capt. Dannevig exploited the uninhibited spawning of resident fish

stock in hatchery ponds for his egg supply; this method was adopted by most other European hatcheries.

Incubation techniques were also different. The Americans modified the Chester jar and McDonald box (used in fresh-water hatcheries) to accommodate both pelagic and demersal marine eggs (Brice, 1898). Spawn was kept in constant motion by means of a periodic rise and fall in incubator water level. Dannevig (1910a) on the other hand, achieved a similar effect by automatically rocking his incubator boxes in a trough of running sea water. In neither case was there adequate control of the hatchery environment; high egg losses usually occurred in unfavorable weather.

Despite occasional set-backs, annual production was generally measured in 'astronomical' terms of millions of newly-hatched larvae released into local waters. Some sceptics refused to be impressed, and called for proof that marine hatcheries were substantially increasing the abundance of marketable fish. They were answered with hearsay evidence for the most part, though two attempts were made to substantiate claims by experiment—one in Norway, the other in Scotland.

1. *Hearsay evidence.* As early as 1883, only five years after the first experimental release of cod-fry, the U.S. Fish Commission reported the appearance of gray cod of a size not previously seen in coastal waters around Gloucester Station. They were generally accepted as the fruits of hatchery effort and became known locally as "Fish Commission cod." In 1898, Herdman (1889), director of the Manx hatchery, received a letter from the U.S. Fish Commissioner, which read. . . . "For about ten years the cod work has been attended with marked success, and in Massachusetts, has resulted, not only in establishing the inshore cod fishery on grounds long exhausted, but through favorable distribution of the fry, in extending the fishery to waters not originally frequented by the cod." As late as 1929, statements were being made to the effect that the winter flounder became more abundant after planting newly-hatched fry.

Dannevig (1910b), in a report on the utility of sea-fish hatching, stoutly opposed the criticism that his hatchery effort was ineffective, and in this he was supported by parish councils, commercial marine societies and private fishermen. They all agreed that an unusual number of small cod made their appearance in fiords, wherever fry were planted, and that these young fish usually had a different color to that of the local race.

Hjort and Dahl (1900) were the leading critics of the marine hatchery movement. They were convinced that the reported increases in abundance of fiord cod after the establishment of a hatchery at Flødevigen, were due to natural variations in the approach of offshore fish to the coast.

2. *Experimental evidence.* An attempt to resolve this dispute by experiment, was made in Norway between 1903 and 1905. Capt. Dannevig and Knut Dahl, representing both factions, conducted annual surveys

for O-Group cod, with a large seine net in two Skagerak fiords, before and after larval liberations from the Flødevigen hatchery. Table 1 is a summary of basic data taken from Dahl and Dannevig (1906) by Fulton (1908). Dannevig interpreted results as supporting the view that liberations were effective, while Dahl was quick to emphasize the importance of natural fluctuations, as in Hellefjord, 1903-4. The evidence is not conclusive; observations should have been continued by a strictly impartial team for many more years.

TABLE 1  
BASIC DATA FROM A NORWEGIAN EXPERIMENT TO TEST THE PRACTICAL VALUE OF COD FRY LIBERATIONS (AFTER FULTON, 1908)

	SØNDELEDFJORD			HELLEFJORD		
	Cod larvae liberated (millions)	Total catch 0-group cod	Mean number per haul	Cod larvae liberated (millions)	Total catch 0-group cod	Mean number per haul
1903.....	None	426	4.8	None	36	1.9
1904.....	20	1,523	15.1	None	133	6.5
1905.....	28	1,133	11.5	8-9	143	7.5

From 1896 to 1901 inclusive, plaice fry reared at the Scottish hatchery were transported overland for release into the upper reaches of Loch Fyne, on the west coast. Pushnet surveys for metamorphosed plaice were made at five specially selected stations within the loch during the summer months following each annual liberation, and these surveys were continued for six years (1903-8) following the last release. Results were published by Fulton (1908); for the purpose of this brief history, I reproduce the basic data only (Table 2). Fulton's more detailed

TABLE 2  
LOCH FYNE EXPERIMENTS WITH LIBERATED PLAICE LARVAE (AFTER FULTON, 1908)

Year	No. Larvae liberated (nearest million)	Duration of fishing hrs. mins.	No. of 0-Group plaice taken	Mean catch per hour
1896.....	4	10 --	1,114	111.4
1897.....	21	2 30	60	24.0
1898.....	19	12 30	1,195	95.6
1899.....	16	17 --	488	28.7
1900.....	31	16 --	850	53.1
1901.....	51	16 --	2,784	174.0
TOTAL.....	143	74 --	6,491	87.7
1903.....	Nil	33 --	1,231	37.3
1904.....	"	31 45	253	8.0
1905.....	"	29 45	3,333	112.0
1906.....	"	30 25	505	16.6
1907.....	"	8 50	294	33.3
1908.....	"	31 45	961	30.3
TOTAL.....	Nil	165 30	6,577	39.7

analysis of statistics continued to support his main conclusion—that the mean yield of young plaice per hour during those years when larvae were liberated, was double the take during an equal period following the last release. He judged this difference to support the view that hatchery effort was worthwhile.

### REARING MARINE FISH THROUGH THE LARVAL PHASE

Hjort and Dahl (1900), in their detailed criticism of hatchery methods as then practiced, stressed the fact that despite 20 years effort, no way had been found of rearing large numbers of marine fish larvae, beyond the yolk-sac phase, to a tough stage of development suitable for release into the sea. They went on to say . . . “that if the work of hatching could be perfected, so that, by its aid, the larvae of the plaice could be kept alive beyond the pelagic stage, and reared until it settled on the bottom, a way might thus be found of increasing the stock of this species on our shores”. Petersen (1899) had early realized the need to improve hatchery technique, but after several attempts to rear plaice, he became convinced that . . . “at the pelagic stage, after the yolk has been absorbed, it cannot be kept alive in aquaria”.

But already, Meyer (1878) had reared small numbers of Baltic winter herring through metamorphosis, in a tub of sea water partly refreshed each day. The survivors fed on plankton introduced into the tub with water renewals. Rognerud (1887) described an experiment by Capt. Dannevig at Flødevigen, in which 1-2 per cent of cod fry introduced into a marine pond, survived 8 months on plankton and triturated mackerel flesh.

At Dunbar, Harald Dannevig (1897) successfully reared a few plaice through metamorphosis in a glass carboy holding 45 liters of sea water. He introduced 1200 newly-hatched fry, fed them on plankton tow-nettings, and attributed much importance to the fact that convection currents kept the early larvae in gentle motion. Fabre-Domergue and Bietrix (1905), at Concarneau, France, had similar success with the larvae of the sole (*Solea vulgaris*), fed on cultured flagellates and on plankton collected from neighboring rock pools. The French naturalists used a helical disc rotated on a vertical axis, to agitate occasionally renewed sea water in a 45 liter carboy. Anthony (1910) employed a similar technique to rear turbot (*Rhombus maximus*) larvae well into the feeding stage, at St. Vaast-la-Hougue, but his feeders failed to reach metamorphosis.

A few German coastal herring were reared by Schach (1939) and Kotthaus (1939) through the delicate early stages, to 40-60 mm in length, while in America, Galtsoff and Cable (1933) devised a current rotor suitable for rearing certain marine fish larvae, including the mackerel, sand-dab and tautog.

Up to the outbreak of the 1939-45 war, no determined attempt had been made to solve the outstanding hatchery problem of the time—how to produce a suitable larval food in bulk. Without this knowledge, the mass-production of sea fish was impossible,

and work on the commercial value of artificial propagation could not be taken a stage further, as suggested by Hjort and Dahl (1900).

Prospects for the mass-culture of young sea fish improved substantially when Rollesfsen (1939, 1940) discovered that the nauplius of *Artemia salina* (the brine shrimp) was an easily cultured and acceptable food for larval plaice. He reported being able to house many thousands of feeding larvae at Trondhjem hatchery, in an illuminated tank of 200 liters capacity, irrigated with running sea water. This promising advance was halted temporarily by the war. When hostilities ceased, experimental rearing studies continued at Flødevigen (Dannevig, 1948; Dannevig and Dannevig, 1950; Dannevig and Hansen, 1952). Their reports dealt, in a general way, with the possible causes of larval mortality in aquaria, including “gas disease”, light intensity, parasitic attack and the effect of catabolic products of fish in sea water. By 1952, there were good samples of O-group herring, O and 1-group plaice and 5-year-old sole at the Flødevigen hatchery, all reared from artificially fertilized or pond-spawned eggs.

With the exception of Norwegian research, post-war attempts to rear marine fish larvae have been undertaken in the wider context of physiology, ecology and taxonomy, rather than practical fish culture. They include work by McHugh and Walker, (1948); McMynn and Hoar, (1953); Blaxter, (1955, 1956, 1957, 1962); Holliday and Blaxter, (1960); Blaxter and Hempel, (1961) and Klima *et al.*, (1962), to mention but a few.

Useful technical information on marine fish rearing has also accrued from research into factors affecting meristic characters within species. Tåning (1952) pointed out that meristic studies had been largely confined to fresh-water fish due to the unpredictable nature of marine eggs and larvae as experimental material. One exception was the work of Gabriel (1944) who reared *Fundulus heteroclitus*, to successfully relate temperature conditions and vertebral count. Dannevig (1950) studied the plaice in the same context, and confirmed Gabriel's findings. This was followed by a most interesting meristic experiment in Sweden, where Molander and Molander-Swedmark (1957) reared artificially-fertilized plaice eggs in open circulation with temperature control, achieving occasional survivals to metamorphosis exceeding 40 per cent of original egg stock.

When technical studies began at the Lowestoft Fisheries Laboratory in 1957, we had every confidence that plaice could be reared in captivity. Our aim was to develop a consistent technique which could easily be expanded into a mass-production technology.

### RECENT PLAICE-REARING EXPERIMENTS IN BRITAIN

The plaice, a prime flatfish of north European waters, normally takes four or five years to reach first maturity, when the female may release 30-50,000 eggs. This figure increases with size of the fish. The fertilized egg is buoyant, transparent and about 2 mm in

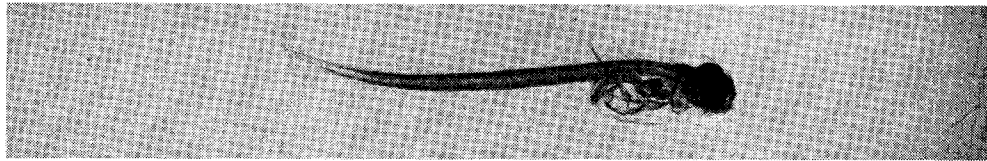

Stage 1

6.0 mm

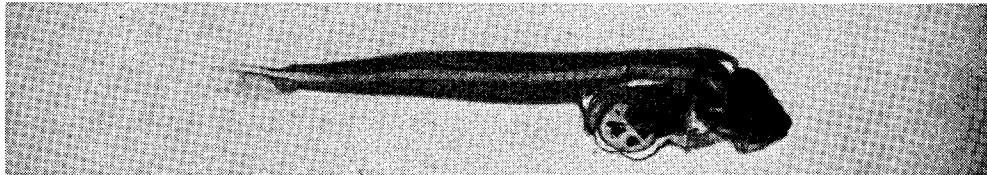

Stage 2

7.5 mm

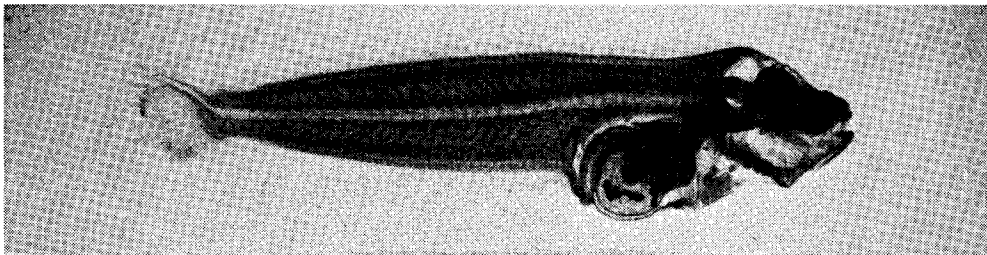

Stage 3

9.3 mm

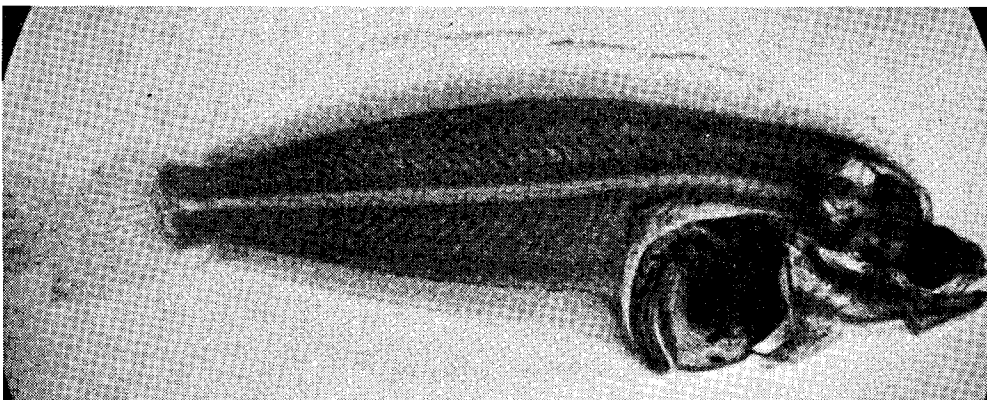

Stage 4

12.3 mm

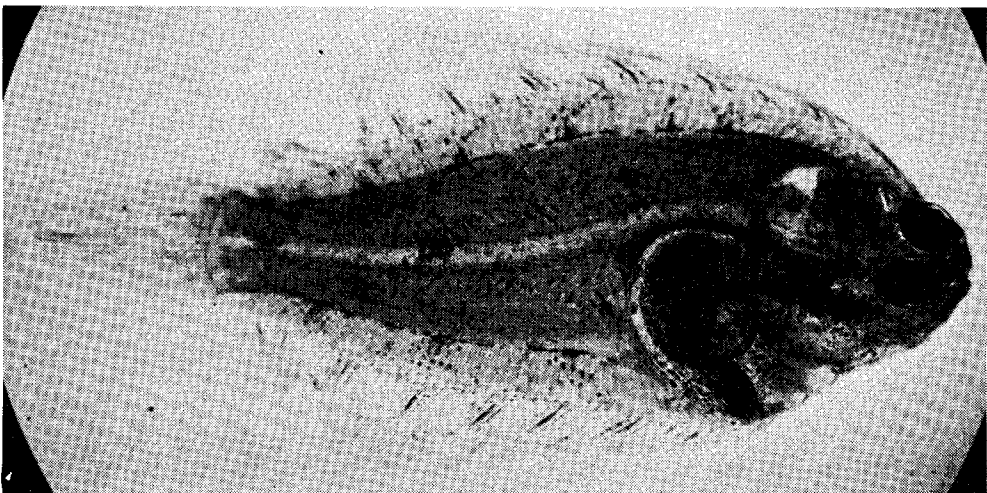

Stage 5

12.4 mm

Figure 1. Development of larval plaice.



diameter. After three weeks at normal sea temperature, the egg hatches to liberate the first stage larva shown in Figure 1. It is about 6 mm long, delicate but active, and will start feeding on suitable zooplankton four or five days after hatching, before the yolk is exhausted. The eyes are precociously developed and symmetrically placed. During the next seven weeks or so, the pelagic larva passes through stages 2 and 3. At stage 4, pigment appears on the right side of the body, the left eye migrates by differential growth to the right, now dorsal side, and the metamorphosed larva adopts the demersal habit. Stage 5 is a metamorphosed plaice 10 weeks after hatching. It is tough, has 'built-in' food reserves, and would seem to have reasonable chances of further survival in the sea.

1. *Plaice-rearing in closed circulation at Lowestoft.* Between 1951 and 1956, plaice eggs, caught at sea were kept in well-lighted glass jars (capacity 2 liters sea water) standing in temperature-controlled water baths, mainly to provide material for morphological studies. Even if egg mortalities were not unduly high in these static conditions, larval survivors seldom developed beyond the early feeding stage, and structural abnormalities were common. A disturbing fall in the pH of incubator sea water often preceded egg and larval mortalities, probably due to the excretion of acid catabolites by livestock and bacteria.

By 1957, a closed circulation giving a limited degree of physico-chemical control had been designed (Fig. 2). It incorporated a basic principle of tropical aquarium technique . . . the use of photosynthesizing plants to remove CO<sub>2</sub> and other metabolites from the water, thus stabilizing the pH and adding oxygen at the same time. Two 2 ft × 1 ft × 1 ft molded glass incubators were partially immersed in a wooden freshwater bath cooled by a copper coil linked to a domestic refrigerator unit. Sea water ran into each incubator at a slow controlled rate, from a glass header tank containing washed fronds of the alga *Enteromorpha intestinalis* growing on pebbles collected from a local estuary. The alga received strong illumination from a battery of tungsten-filament lamps, each lamp being independently switched. A rise in pH above 8.1, which lies within the favorable range quoted by Bishai (1960), could be countered by decreasing the light intensity.

Each glass incubator contained a right-angled outlet (strictly overflow) pipe, screened at its lower end with fine-mesh bolting silk. Dim light entered the incubator through slits in the water bath cover, and a slow circulation of cooling water was maintained by an air pump. There was neither direct aeration of eggs, nor agitation of sea water. The incubator outflow drained into a lower reservoir, to be recirculated into the header by a small centrifugal pump fitted with a plastic volute. Incubators were stocked with 300-500 eggs, and the emergent larvae fed on *Artemia nauplii*.

This system gave limited, but positive results, and in 1959 the same principles were applied in a much bigger assembly (Fig. 3), comprising a large, sunken concrete reservoir, and a brick-built hatchery contain-

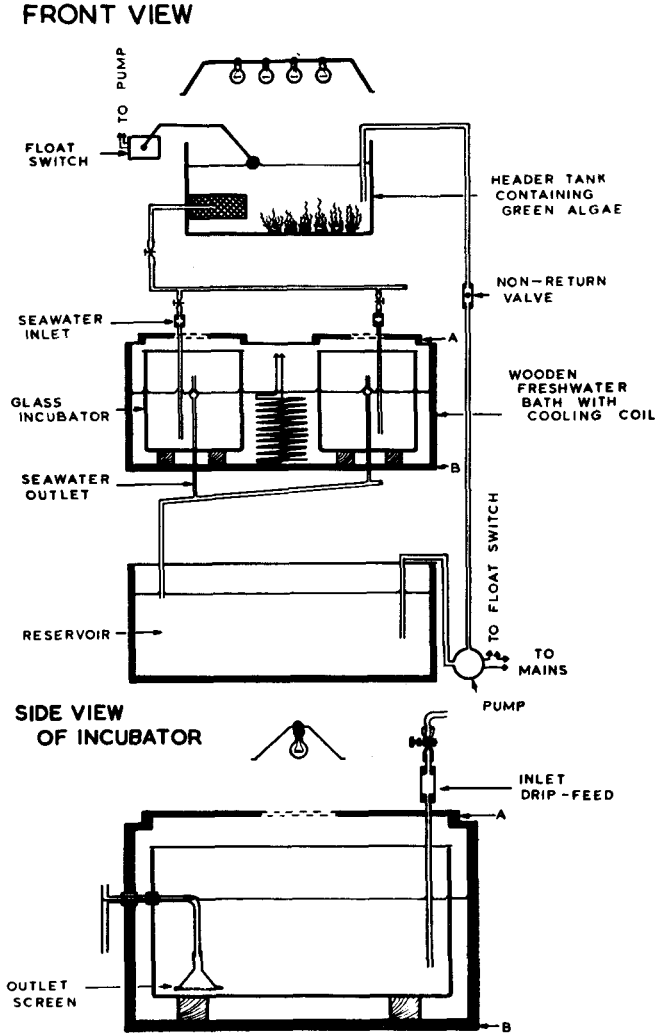

FIGURE 2. Closed sea water circulation for rearing plaice: Lowestoft, 1957.

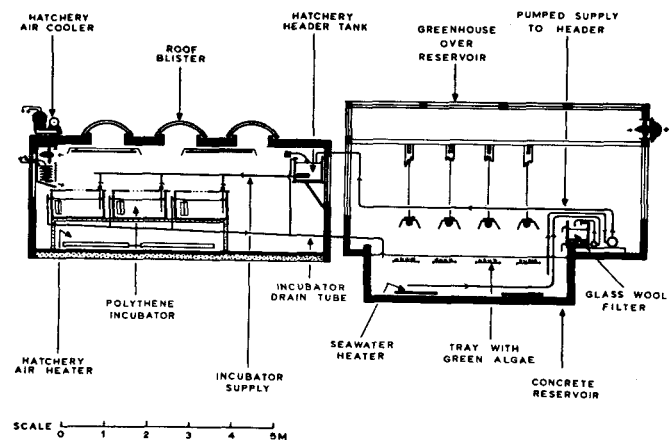

FIGURE 3. Closed sea water circulation for rearing plaice: Lowestoft, 1960.

ing a cluster of 5 ft × 2 ft × 2 ft polythene incubators. *Enteromorpha* was once again used to control pH and CO<sub>2</sub> concentration in the reservoir, which was covered by a greenhouse to permit algal photosynthesis during the day. The alga was illuminated by fluorescent light at night. Reservoir sea water was continuously pumped through a composite filtration, U.V. sterilization and cooling system. Additional temperature control was provided by air cooling units in the hatchery.

The total capacity of this new closed circulation was 15,000 liters, and permitted us to increase the annual production of metamorphosed plaice from a single fish in 1957, to about 3000 fish in 1961, by the simple expedient of increasing egg stocks from year to year (Fig. 4). Mean survival rates remained low however, seldom exceeding 5 per cent of original eggs. Details of lay-out, procedure and results have been published by Shelbourne *et al.* (1963) and Riley and Thacker (1963).

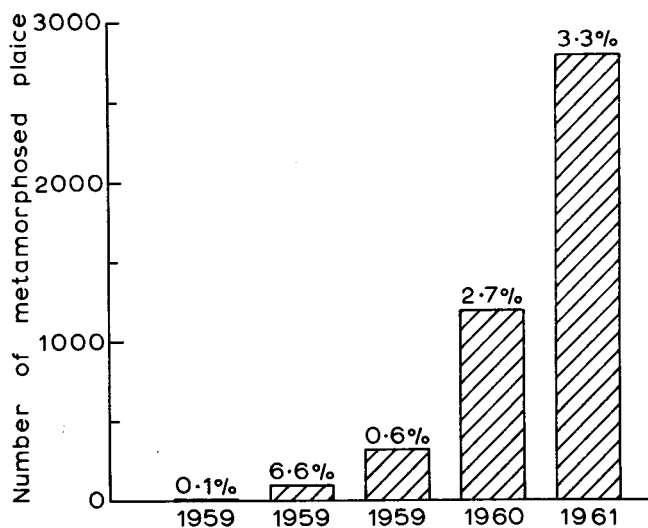

FIGURE 4. Annual production of metamorphosed plaice larvae, and percentage survival of original eggs, during rearing experiments at Lowestoft.

*2. Plaice-rearing in open circulation at Port Erin, Isle of Man.* Already in 1960, it was evident that an accessible supply of eggs and a continuous flow of good quality sea water was necessary for further progress towards large-scale plaice production. Both these conditions could be met at the Marine Biological Station, Port Erin, Isle of Man, which enjoys a hatchery tradition extending back to 1902.

Adult plaice spawn freely in large shallow ponds, but little was known about the viability of such spawn. A preliminary experiment in 1960 showed that pond-spawned eggs could give survivals to metamorphosis similar to those experienced with sea-spawned eggs, using the Lowestoft technique as it then stood. The mean 1960 survival curve (Fig. 5) was plotted by regularly removing and counting the dead in a batch of six small glass rearing tanks, each stocked with a thousand eggs. It shows the so-called 'critical period' in the tank life of a developing plaice stock, between the time when the egg yolk is used up, and the establishment of regular feeding habits.

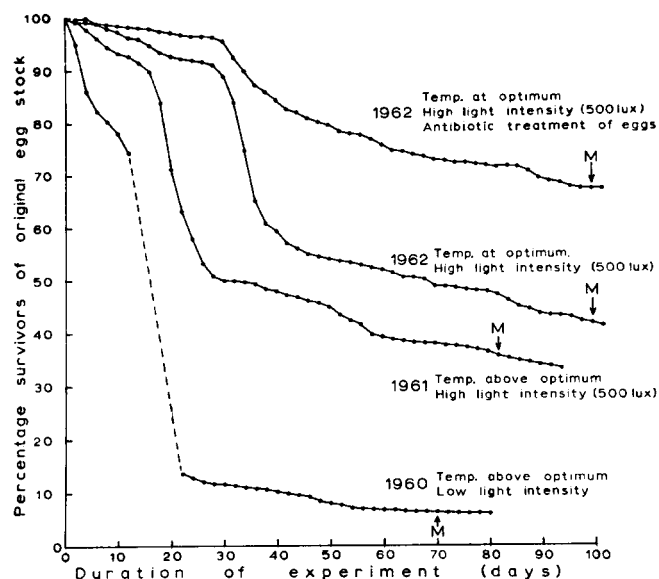

FIGURE 5. Survival curves for plaice stock in open circulation at Port Erin, 1960-62. M=metamorphosis complete.

The following year we concentrated on improving conditions during this short period—in particular, by making the food organisms (*Artemia nauplii*) more available to fish larvae. Rearing tanks were fitted with jackets of black polyethylene film to cut out side lighting. At the same time, the overhead illumination was increased from a low intensity to 400-500 lux at the water surface, as measured with a photometer corrected by filter to the wave-length response of the human eye. The results were encouraging (Fig. 5). Almost 50 per cent of newly-hatched larvae began feeding, and a final 33 per cent of the original stock passed through metamorphosis. Plaice larvae are visual feeders, but early on, their sight is not yet acute. They capture their prey more easily when it is highlighted against a contrasting background. At a later stage of pelagic development, light intensities can be cut down to a very low level indeed. By this time the eye is efficient and the larvae well practiced in the art of hunting.

Another major technical advance was made in 1962. It is a well-established fact that marine bacteria grow more readily in tanks than in the open sea. Over the plaice spawning grounds in the Irish Sea, bacterial counts may be as low as 50 per ml, whereas my tanks may contain several thousands per ml, even before eggs are put in. Bacteria proliferate on the egg shells making them sticky and opaque; eggs adhere one to another, and a variable proportion, depending on the degree of contamination, will die before hatching. Eggs which do not die may nevertheless be weakened by toxins or perhaps by direct infection.

Oppenheimer (1955) demonstrated the beneficial effect of antibiotics on the hatching rate of marine fish eggs. So, in 1962, a long-term experiment was set up to test the effect of early bacterial control on final survival to metamorphosis. Pairs of glass incubators were partially immersed in four water baths equipped with temperature control gear. Each tank could be

irrigated with hatchery sea water, but only one tank of a pair was irrigated during the period of egg incubation. The other was treated with one dose of a sodium penicillin G and streptomycin sulfate mixture (50 international units and 0.05 mg per ml respectively), and then kept static until hatching began. All tanks were irrigated during the larval phase. The effect of antibiotic treatment can be seen by comparing a representative pair of 1962 curves in Figure 5. Both stocks enjoyed the same temperature conditions, illumination, tank design and feeding rate; the upper stock was treated, the lower one was not. At the end of the experiment, young fish were thick on the bottoms of the tanks, with the highest densities approaching 350 per ft.<sup>2</sup>, representing survival rates exceeding 60 per cent of original eggs.

As a matter of interest, tank survivals of this order are at least several hundred times greater than the highest estimated survival in natural conditions (Gross, 1950). Low survivals in the sea are probably due mainly to food shortage and predation. These factors are absent in hatchery tanks, but other hazards take their place. I have mentioned one, namely bacteria, which we can control with antibiotics, and to some extent, with ultra-violet radiation. Another is the temperature regime in uncontrolled tanks. For plaice, a practical schedule is to incubate eggs at 6°-7°C, rising to 7°-8°C at 'first feeding', followed a gradual increase to 11°-12°C at metamorphosis. A third and very potent hazard concerns the design of tanks themselves. A plaice larva is adapted to an active life in the open sea, out of contact with surfaces until metamorphosis. Continual contact with tank walls is an unavoidable tank hazard which may put a considerable strain on the adaptive resources of a marine larva. It is therefore important to keep a tank interior as simple as possible, with no unnecessary inclusions. Two closely apposed surfaces can act as a lethal trap for roaming larvae. Crevices are a particular menace—larvae swim into them and seem unable to back out.

**PECULIARITIES OF TANK-REARED PLAICE POPULATIONS**

After each experiment, surviving stocks of young plaice were killed and preserved. Subsequent analysis revealed certain trends within tank populations, particularly regarding size distribution, the incidence of bitten fins and pigment abnormalities.

1. *Size distribution.* Although efforts were made to maintain a reserve of food in tanks at all times, the survivor length-range for each tank population was characteristically wide, even in those years when incubators were stocked with eggs of equal age. I have rarely found metamorphosed plaice larvae less than 13 mm long in the sea, but a fair proportion of tank survivors regularly metamorphosed before reaching this size.

It is our experience that in comparable tanks, those with smaller surviving populations contain a significantly greater proportion of larger larvae. This trend

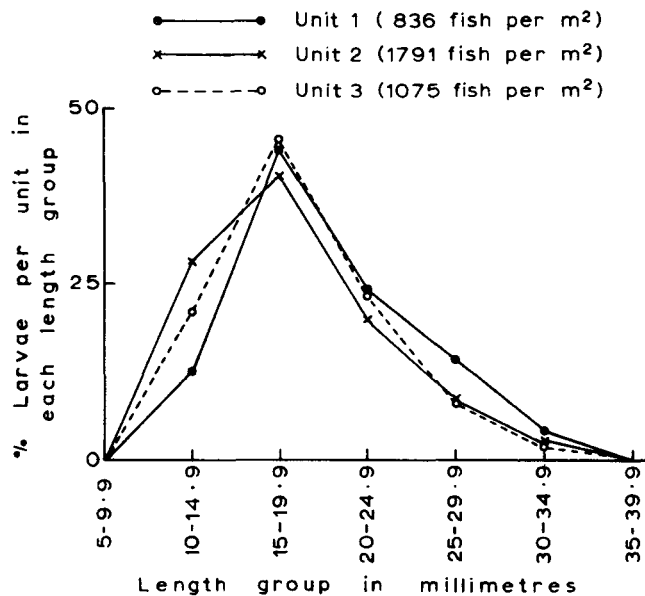

FIGURE 6. Length distribution of plaice survivors in rearing units with different survivor densities: Port Erin, 1961.

can be seen in Figure 6. To emphasize the point the same populations have been divided into large (> 20 mm) and small (< 20 mm) survivors, and then arranged in order of increasing population density (Fig. 7). The disproportionate number of small larvae among denser populations is clearly seen. Whether this was due to competition for food or the differential mortality of slow-growing forms, remains to be seen from further experiment.

Survival or death, fast or slow growth, all reflect large differences in individual adaptability to tank

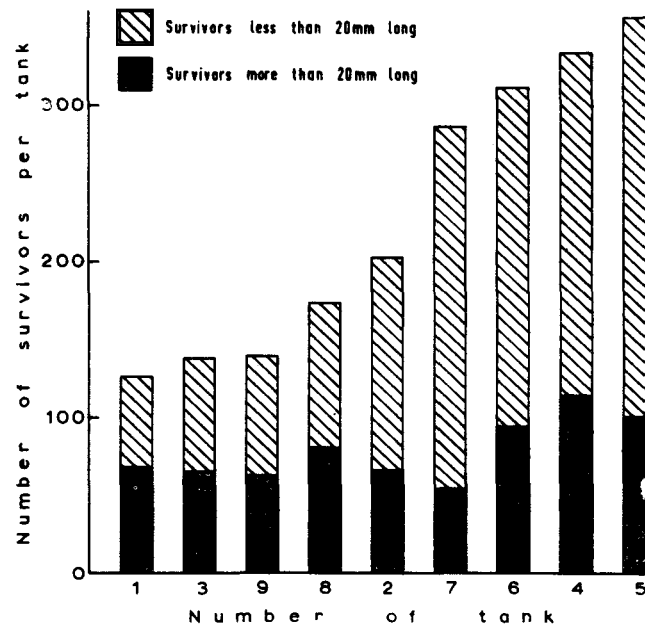

FIGURE 7. Proportions of large and small plaice in tanks with different survivor densities: Port Erin, 1961.

conditions. By this token, it is not at all certain that the larger survivors would necessarily be the best sort of fish to liberate into the sea as part of an artificial propagation program. On the other hand, if large size and 'seaworthiness' are related, then it would be efficient hatchery practice to eliminate the retarded members of a mixed tank population as early as possible—virtually skimming the cream of the stock. Target production at a low survival rate might then be met by boosting egg stocks.

2. *The incidence of bitten fins.* Metamorphosed plaice larvae bite each other when crowded together in hatchery tanks, the damage usually being sustained on the marginal or caudal fins. Damaged tissue can be regenerated, but a severe bite on a small larva could conceivably be lethal, if repairs remain incomplete before the osmoregulatory resource of the casualty is overtaxed. Bitten larvae will almost certainly be more prone to bacterial and fungal attack.

The incidence of biting varied from tank to tank in 1960 and 1961 at Port Erin, and bore little relationship to population density (Fig. 8). A more consistent correlation emerged between the incidence of biting and the size of fish (Fig. 9). Thus, within a mixed size population, with perhaps occasional food shortages, smaller fish are more likely to suffer damage from biting activity, than their larger contemporaries. Cannibalism is perhaps too strong a term to use, though adult plaice in spawning ponds have been seen to eat their newly-metamorphosed young. Biting is a manifestation of normal feeding behavior; plaice larvae instinctively snap at smaller moving organisms.

3. *Abnormal pigmentation.* At metamorphosis, the ability of a larva to merge with the background coloration will play a vital part in future survival, since defensive armament is ill-developed in the plaice. During the course of evolution, under conditions of severe selection, one might expect normal pigmentation to become a very stable characteristic indeed. Abnormally pigmented flat fish occasionally occur in the sea (Norman, 1934; Gudger, 1935, 1941; White, 1962; Eisler, 1963) but in tanks, a substantial proportion of metamorphosed survivors always show pigment deficiencies on the dorsal side, ranging from slight loss on the lower margin of the operculum to virtual absence except for traces of melanin around the eyes or on the base of the fins.

In my experience, the degree of abnormality has varied from season to season, and from place to place. For instance, at Lowestoft in 1960, 62 per cent of all survivors were normally pigmented, compared with 55 per cent at Port Erin the same year and 19 per cent in 1961. Dannevig and Hansen (1952) reported that plaice eggs hatch well in total darkness, but the larvae seem pre-disposed towards abnormal pigmentation later on. Pigment deficiency might also bear some relation to population density at metamorphosis. In Figure 10, the mean percentage of dorsal pigment for the whole of a tank stock is plotted against the survivor density. The per cent pigment cover on the

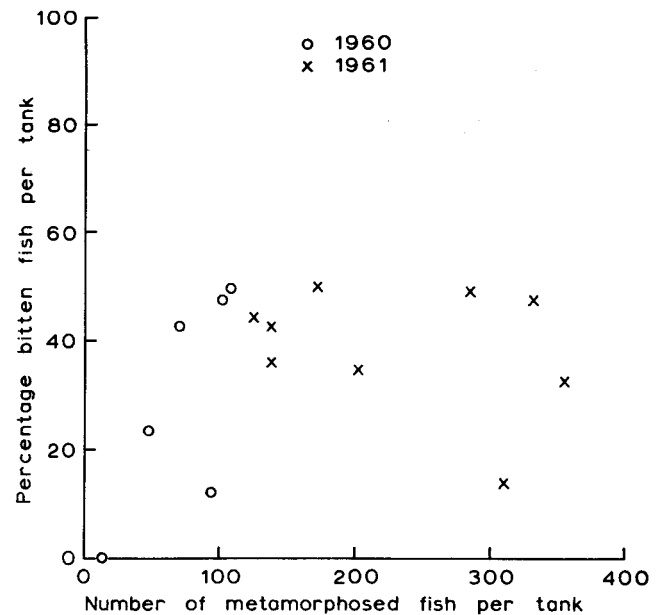

FIGURE 8. The relationship between the incidence of bitten fins among tank-reared plaice, and the population density.

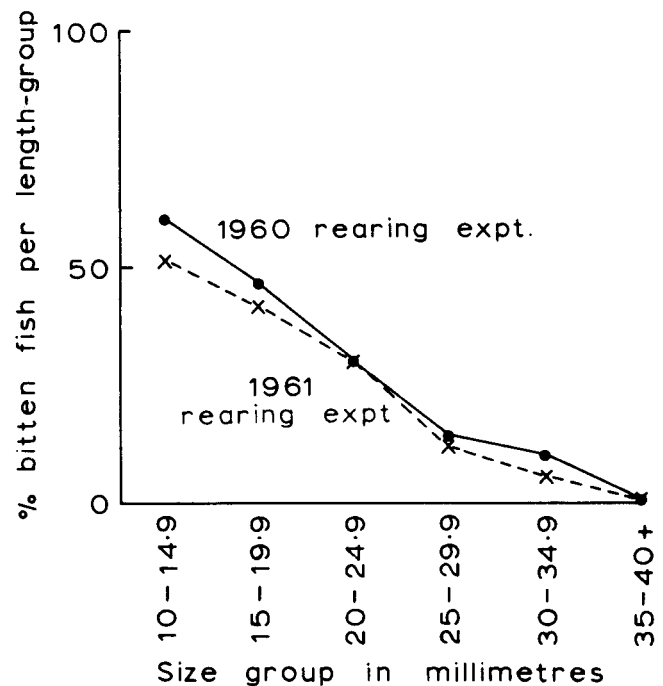

FIGURE 9. Relationship between the incidence of bitten fins among tank-reared plaice, and size of fish.

dorsal side of each larva was assessed by eye. Results cover the years 1960 and 1961 at Port Erin; all tanks were of equal size, though the rearing techniques for both years are not strictly comparable. The apparent trend towards better pigmentation with decreased population density is probably linked with a second relationship given in Figure 11, showing that smaller survivors among a stock usually have less pigment cover than their larger contemporaries. It has al-

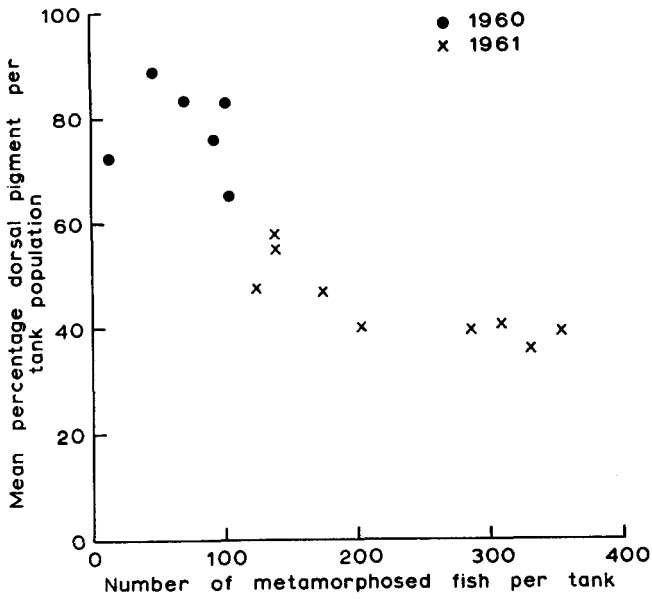

FIGURE 10. Relationship between population density and mean dorsal pigment cover among tank-reared plaice: Port Erin, 1960 and 1961.

ready been demonstrated that densely populated tanks are biased in favor of smaller larvae (Figs. 6 and 7). Experiments in 1962 also suggest a relationship between the degree of pigmentation at metamorphosis, and the temperature regime during incubation and larval development.

It looks as if chromatophore development during organogeny is a particularly sensitive and delicate process, easily disrupted by an unfavorable environment. Heuts (1953) made this point with reference to the regressive evolution of *Caecobarbus geertsii*, the blind cave fish of the Congo. Follet (1954), on the other hand, related the piebald condition in flatfish to vertebral damage, while von Ubisch (1952) considered light intensity to be important. The tank environment, involving surface contact and community conditions, is completely alien to the pelagic plaice larva, and it says a great deal for the innate adaptability of the species, that high survivals to metamorphosis can be achieved, even though abnormalities commonly occur. Since effective hatchery production for release into the wild can only be measured in terms of normally pigmented plaice larvae having a reasonable chance of survival after metamorphosis, the causes and cures of pigment deficiency are matters of great practical interest, and further experiments are planned to widen our understanding of this condition.

**TOWARDS MARINE FISH FARMING**

There are several different ways in which the output of a functional marine hatchery could be utilized to augment fish resources. All require a consistent technology for the annual production of young flatfish on a very large scale indeed. During the 1962 rearing experiments, a total of 25,000 metamorphosed plaice

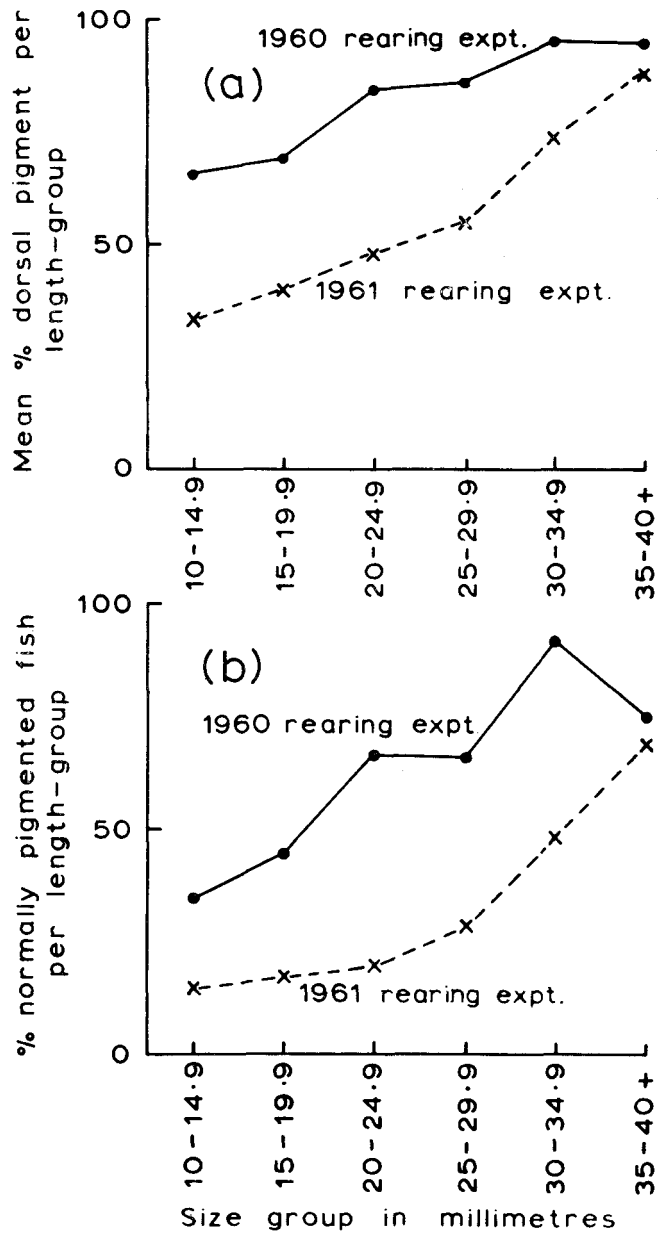

FIGURE 11. Relationship between survivor size and degree of dorsal pigmentation: Port Erin, 1960 and 1961.

were incidentally produced; plans to push this figure up to 1 million per annum during the next five years are well advanced.

A specially designed marine hatchery is now being erected on the Isle of Man, incorporating most of the relevant information gained during the past few years. It is a prefabricated, insulated structure, with air and water temperature control. About 250 black plastic incubators (4 ft x 2 ft x 1 ft deep) will be arranged in rows and layers in a space not exceeding 45 ft x 30 ft x 12 ft overall. Each incubator will be independently illuminated—the problem of heat production from light fittings has already been overcome in a test system, by situating lamps in a transparent air-duct connected to extractor fans. The building will

also contain sectional fiberglass spawning ponds, pressure filtration and ultra violet sterilization systems.

A special insulated space, operating at 23°C has been allocated to the production of larval food. At peak feeding we calculate that 200 million *Artemia* nauplii per day must be made available; in round terms, about 1 cu. yd. of *Artemia* eggs will be required to raise one million fish, if nauplii alone are used as food. *Artemia* nauplii are, however, easily cultured on yeast and the alga *Phaeodactylum tricorutum*; bigger *Artemia* will be supplied to bigger fish. We are making an experimental study of other possible food sources, such as *Mytilus* trochophores and larvae, and various encytraeid oligochaetes. The latter are readily cultured on a damp mixture of peat loam and precooked meal.

Assuming we raise our experimental technique for rearing plaice to the status of a mass production technology—and no insuperable difficulties are foreseen—then there are three main ways in which hatchery production could be utilized in the British Isles. Firstly, to augment natural recruitment in inshore waters, as suggested by Hjort and Dahl (1900). We are under no illusion about the immense numbers of hatchery fry that may be required to carry through this project. For instance, it has been estimated that between 500 million and a billion young plaice would have to be liberated in any one year to double the normal brood strength in the North Sea plaice fishery. In the smaller bay fisheries of the Irish Sea, increments of one million or so might be beneficial. Only under conditions of strict fishery control could one expect to reap the full benefits of an artificial recruitment program. Nevertheless, small scale field experiments are a necessary prelude, and surveys of suitable inshore grounds are now being made by the Lowestoft Fisheries Laboratory, in anticipation of the time when hatchery recruits will be available.

A second project, still in the planning stage, involves the release of hatchery flatfish into partly enclosed sea areas enriched with agricultural fertilizers. During the last war, a team of scientists under the late Dr. Fabius Gross of Edinburgh University, showed that inorganic fertilizers scattered into Scottish sea-lochs, could produce remarkable increases in the abundance of fish food. Resident and transplanted plaice were found to grow three or four times as fast as the stock outside. Dr. Gross (1950) was unable to exploit fully this increased food supply—transplants were difficult and expensive to obtain. Now they can be supplied from a hatchery, on site.

Our common food fishes take four or five years to reach marketable size in the sea. Winter growth is restricted by low water temperatures and perhaps seasonal food scarcity. As a third line of research, we are exploring the possibility of fattening hatchery reared fry in shore ponds irrigated by the warm outflow from coastal power stations, some of which are discharging 30 to 50 million gallons of sea water per hour at a temperature 7° C above intake level. In good conditions for continuous rapid growth, we might be able to reduce the time taken for a plaice, sole or turbot to reach marketable size, from 5 years to 18

months. It should not be too difficult to develop a cheap fish food based on agricultural by-products and fish offal, or to organize the mass-culture of the common mussel (*Mytilus edulis*) as a source of food. Controlled 'battery' production in marine ponds would enable fish processing firms to tailor their plant to deal with a continuous, predictable supply.

In a sense, we are now entering a transition period; while still relying on a hunted, natural stock for fish supplies, there is a growing international awareness of the inadequacies of such a policy, which must inevitably lead to the final farming and domestication of marine fish on a considerable scale.

## REFERENCES

- Anthony, R., 1910. The cultivation of the turbot. Proceedings of the 4th International Fishery Congress, Washington, 1908, Pt. 2. Published as *Bull. U.S. Bur. Fish.* 28: 861-870. (Translation).
- Bishai, H. M., 1960. The effect of hydrogen ion concentration on the survival and distribution of larval and young fish. *Z. wiss. Zool.* 164: 107-118.
- Blaxter, J. H. S., 1955. Herring rearing—I. The storage of herring gametes. *Mar. Res. Scot.* No. 3, 12 pp.
- Blaxter, J. H. S., 1956. Herring rearing—II. The effect of temperature and other factors on development. *Mar. Res. Scot.*, No. 5, 18 pp.
- Blaxter, J. H. S., 1957. Herring rearing—III. The effect of temperature and other factors on myotome counts. *Mar. Res. Scot.*, No. 1, 16 pp.
- Blaxter, J. H. S., 1962. Herring rearing—IV. Rearing beyond the yolk sac stage. *Mar. Res. Scot.*, No. 1, 18 pp.
- Blaxter, J. H. S., and G. Hempel, 1961. Biologische Beobachtungen bei der Aufzucht von Heringsbrut. *Helgoländ. wiss. Meeresunters.* 7: 260-283.
- Borley, J. O., 1923. The plaice fishery and the war. Preliminary report on investigations. *Fish. Invest. Lond.*, Ser. 2, 5 (3): 56 pp.
- Brice, J. J., 1898. A manual of fish culture, based on the methods of the United States Commission of Fish and Fisheries. *Rep. U.S. Comm. Fish.*, 1897, Appendix, 1-340.
- Dahl, K., and G. M. Dannevig, 1906. Undersøgelser over nytten af torskeudklækning i ostlandets fjorde. *Aarsberetn. Norg. Fisk.*, 1906, 1-121.
- Dannevig, A., 1948. Rearing experiments at the Flødevigen sea fish hatchery 1943-46. *J. Cons. int. Explor. Mer.*, 15: 277-283.
- Dannevig, A., 1950. The influence of the environment on number of vertebrae in plaice. *Fiskeridir. Skr. Havundersøk.* 9 (9): 1-6.
- Dannevig, A., and G. Dannevig, 1950. Factors affecting the survival of fish larvae. *J. Cons. int. Explor. Mer.*, 16: 211-215.
- Dannevig, A., and S. Hansen, 1952. Faktorer av betydning for fiskeeggenes og fiskeyngelens oppvekst. *Fiskeridir. Skr. Havundersøk.* 10 (1): 1-36.
- Dannevig, G. M., 1908. "Oplysninger til Udklækningssagens Bedømmelse. Samlede af Arendals Fiskeriselskab, 1908." 88 pp Arendals Bogtrykkeri.
- Dannevig, G. M., 1910a. Apparatus and methods employed at the marine fish hatchery at Flødevig, Norway. Proceedings of the 4th International Fishery Congress, Washington, 1908, Pt. 2, Published as *Bull. U.S. Bur. Fish.* 28: 801-809.
- Dannevig, G. M., 1910b. The utility of sea fish hatching. Proceedings of the 4th International Fishery Congress, Washington, 1908, Pt. 2. Published as *Bull. U.S. Bur. Fish.* 28: 813-816.
- Dannevig, H. C., 1897. On the rearing of the larval and post-larval stages of the plaice and other flat-fishes. *Rep. Fish. Bd. Scot.* 1896, Pt. 3, 175-193.

- Duncan, L. M., and O. L. Meehan, 1954. Propagation and distribution of food fishes for the calendar years 1951-1952. *Statist. Dig. U.S. Fish. Wildl. Serv.* 32, 36 pp.
- Earll, R. E., 1880. A report on the history and present condition of the shore cod fisheries of Cape Ann, Massachusetts, together with notes on the natural history and artificial propagation of the species. *Rep. U.S. Comm. Fish.*, 1878, Pt. 6, 685-740.
- Eisler, R., 1963. Partial albinism and ambicoloration in winter flounder *Pseudopleuronectes americanus*. *Copeia*, No. 2, 275-277.
- Fabre-Domergue, P., and E. Biétreix, 1905. "Developpement de la Sole (*Solea vulgaris*). Travail du Laboratoire de Zoologie Maritime de Concarneau." 243 pp Vuibert et Nony, Paris.
- Follet, E. I., 1954. The case of the piebald flounder. *Pacif. Discovery*, 7 (5) : 24-25.
- Fulton, T. W. 1908. On sea-fish hatching. The Loch Fyne experiments with plaice. *Rep. Fish. Bd. Scot.*, 1907, Pt. 3, 40-72.
- Gabriel, M. L., 1944. Factors affecting the number and form of vertebrae in *Fundulus heteroclitus*. *J. exp. Zool.* 95: 105-147.
- Galtsoff, P. S. and L. E. Cable, 1933. The current rotor. *Science*, 77 (1992) : 242.
- Gross, F., 1950. A fish cultivation experiment in an arm of a sea loch. V. Fish growth in Kyle Scotnish, *Proc. roy Soc. Edin.* 64 (B) : 109-35.
- Gudger, E. W., 1935. Abnormalities in flatfishes (Heterosomata). *J. Morph.* 58: 1-39.
- Gudger, E. W., 1941. A totally ambicolorate flounder, *Platichthys stellatus*, from Alaskan waters. *Copeia*, No. 1, 28-30.
- Herdman, W. A., 1899. On sea-fish hatching. *Rep. Lancs. Sea-Fish Labs.*, 1898, 54-62.
- Heuts, M. J., 1953. Regressive evolution in cave animals. *Symp. Soc. exp. Biol.* 7: 290-309.
- Hjort, J., and K. Dahl, 1900. Fishing experiments in Norwegian fiords. *Rep. Norweg. Invest.* 1: 1-214.
- Holliday, F. G. T. and J. H. S. Blaxter, 1960. The effects of salinity on the developing eggs and larvae of the herring. *J. mar. biol. Ass. U. K.*, 39: 591-603.
- Klima, E. F., I. Barrett, and J. E. Kinnear, 1962. Artificial fertilization of the eggs and rearing and identification of the larvae of the anchoveta *Cetengraulis mysticetus*. *Bull. Inter-Amer. Trop. Tuna Comm.* 6 (4) : 155-178.
- Kotthaus, A., 1939. Zuchtversuche mit Heringslarven (*Clupea harengus*, L.) *Helgoländ, wiss. Meeresunters.* I, 349-358.
- Margetts, A. R., and S. J. Holt, 1948. The effect of the 1939-45 War on the English North Sea trawl fisheries. *Rapp. Cons. Explor. Mer.*, 122 (6) : 27-46.
- McHugh, J. L. and B. W. Walker, 1948. Rearing marine fishes in the laboratory. *California Fish and Game.*, 34: 37-38.
- McMynn, R. G., and W. S. Hoar, 1953. Effects of salinity on the development of the Pacific herring. *Canad. J. Zool.* 31; 417-432.
- Meyer, H. A., 1878. "Biologische Beobachtungen bei künstlicher Aufzucht des Herings der westlichen Ostsee". Wiegandt, Hempel and Parey, Berlin. Translation in *Rep. U.S. Comm. Fish.*, 1878, Pt. 6, 629-638.
- Molander, A. R., and M. Molander-Swedmark, 1957. Experimental investigations on variation in plaice (*Pleuronectes platessa* Linné). *Rep. Inst. mar. Res. Lysekil*, Ser. Biol. No. 7, 3-44.
- Norman, J. R., 1934. "A systematic monograph of the flatfishes (Heterosomata)." Vol. 1, 459 pp Brit. Mus. (N.H.).
- Oppenheimer, C. H., 1955. The effect of marine bacteria on the development and hatching of pelagic fish eggs, and the control of such bacteria by antibiotics. *Copia*, No. 1, 43-49.
- Petersen, C. G. J., 1894. On the biology of our flat-fishes and on the decrease of our flat-fish fisheries. *Rep. Danish biol. Sta.*, 1893, 1-146.
- Riley, J. D. and G. T. Thacker, 1963. Marine fish culture in Britain. 3. Plaice (*Pleuronectes platessa* (L)). *J. Cons. int. Explor. Mer.*, 28: 80-90.
- Rognerud, C., 1887. Hatching cod in Norway. *Bull. U.S. Fish. Comm.* 7: 113-119. (Translation).
- Rollefsen, G., 1939. Artificial rearing of fry of sea water fish. Preliminary communication. *Rapp. Cons. Explor. Mer.*, 109: 133.
- Rollefsen, G., 1940. Utlekking og oppdretting av saltvannsfisk. *Naturen*, 6-7: 197-217.
- Schach, H., 1939. Die künstliche Aufzucht von *Clupea harengus*. *Helgoländ. wiss. Meeresunters.* 1: 359-372.
- Shelbourne, J. E., J. D. Riley, and G. T. Thacker, 1963. Marine fish culture in Britain. 1. Plaice rearing in closed circulation at Lowestoft, 1957-1960. *J. Cons. int. Explor. Mer.*, 28: 50-69.
- Tåning, A. V., 1952. Experimental study of meristic characters in fishes. *Biol. Rev.* 27: 169-193.
- von Ubisch, L., 1952. Untersuchungen über Pleuronectiden. II. (Ambicoloration, Inversion and Bilateralitet). *Arch. Entw. Mech. Org.* 145: 1-61.
- White, J. C., 1962. A reversed ambicolorate post-larval Gulf flounder. *Copeia*, No. 4, 854.

# FUNCTIONAL DEVELOPMENT OF VISUAL PATHWAYS IN LARVAL SARDINES AND ANCHOVIES<sup>1</sup>

HORST O. SCHWASSMANN<sup>2</sup>

Department of Anatomy, School of Medicine, University of California at Los Angeles

## INTRODUCTION

One of the principal purposes of studying the nervous system is to correlate the observed gross and microscopic structure with the dynamic activity of the animal, that is, its behavior patterns. Coordinated swimming movements, feeding, and schooling can be observed in larval fish as soon as the neural pathways, sensory and motor, are sufficiently developed. On the other hand, mating and spawning behavior, which frequently involve extensive migratory movements, require sexual maturity and stimulation from endocrine glands.

This paper describes centers and fiber tracts in the central nervous system of sardine and anchovy which are involved in relaying visual information. Evidence is presented concerning the time during larval development when these morphological features make their first appearance.

Virtually nothing is known about the developing nervous system in sardine and anchovy larvae, and no detailed study of the optic system of these fish exists. Therefore, extensive larval and some adult material of the two species was examined for the present paper.

The species used were *Sardinops caerulea* (Girard) and *Engraulis mordax* (Girard). Isolated brains of adult specimens, fixed in ten percent neutralized formalin, were cut at 10 micra in transverse and sagittal serial sections; all sections were mounted and stained by the Klüver-Barrera (1953) or by the Ziesmer-Bodian (1952) method. Different methods of silver impregnation were tried on larval stages. Best results were obtained with the Ranson-Pyridine (1911) and the Bodian (Ziesmer, 1952) methods.

## THE VISUAL SYSTEM IN THE ADULT

In its external form the central nervous system appears typically teleostean, as seen in Figures 1 and 2. That vision is the dominant sense becomes evident when one compares the relatively large optic lobes with the small forebrain and the small cerebellum. The eyes are so large that their median curvatures are adjacent to each other; they have displaced the small forebrain dorso-caudally.

### *Chiasma opticum and corpus geniculatum laterale*

A complete decussation of the optic nerves occurs at the optic chiasma in all fish. The optic nerve displays considerable lamination in sardine and anchovy.

<sup>1</sup> Supported by United States Public-Health-Service Grant No. B-4578.

<sup>2</sup> Postdoctoral Fellow of the United States Public Health Service.

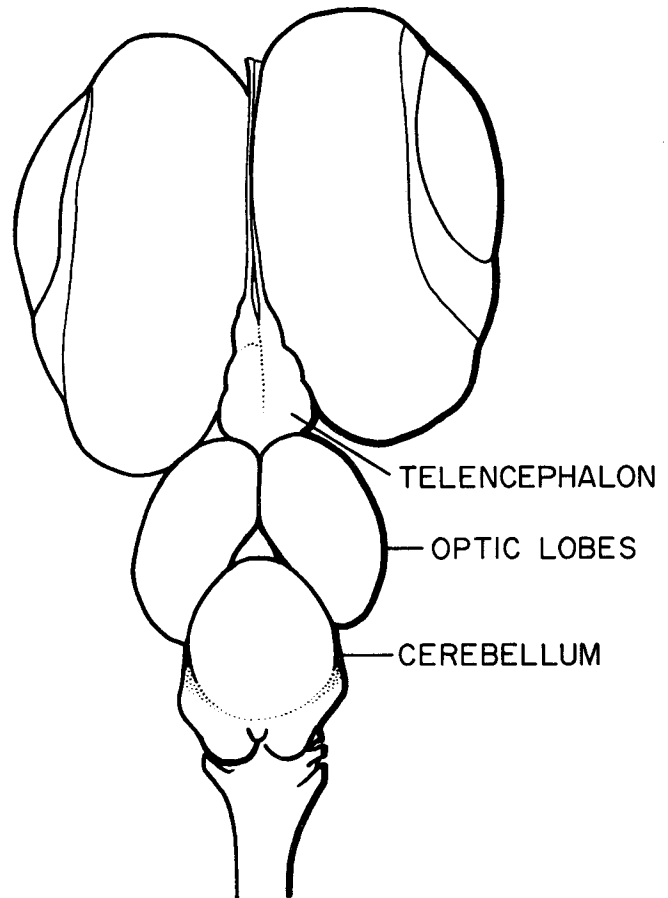

FIGURE 1. Dorsal view of eyes and brain of an adult anchovy.

This pleated condition is common in teleosts, but only in a few species are these bundles known to interdigitate with those of the nerve from the other side. An interdigitating chiasma is common in the herring family as first described for *Clupea harengus* by Weber (1827) where one nerve simply perforates the other. Solger (1877) reported for *Engraulis encrasi-cholus* that four bundles from the right are penetrated by three bundles from the left. An interdigitating chiasma, however, is not confined to the herring family. Gross (1903) noted that in *Abramis* each nerve splits into a large ventral and a small dorsal bundle which interlace with the bundles of the opposite nerve. Lissner (1923) showed that in *Rhodeus amarus* two bundles from the right eye separate three bundles from the left eye. Meader (1934) found similar conditions in *Osmerus* and *Campostoma*. Accord-



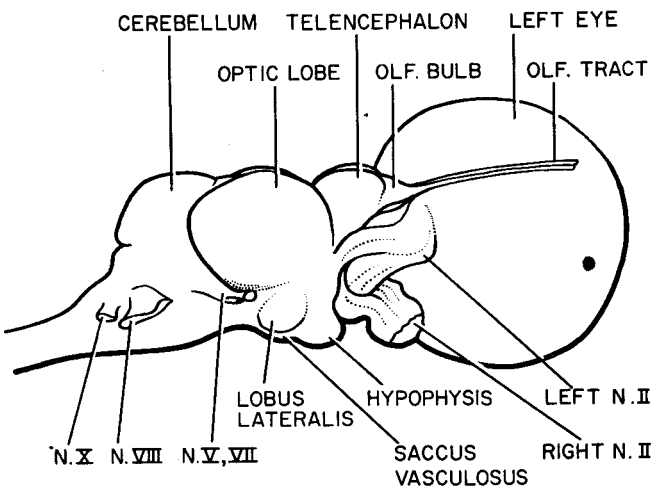

FIGURE 2. Lateral view of the brain of an adult anchovy. The right eye has been removed.

ing to Ströer (1936) in *Salmo salar* each optic nerve consists of two bundles which interdigitate in the chiasma, and which apparently do not re-unite but form the dorsal and ventral optic tracts. The largest number of optic nerve fiber bundles which interdigitate seems to occur in squirrel fish where Meader (1934) described from six to nine mutually perforating bundles in *Holocentrus*.

Each optic nerve of *Engraulis mordax* consists of six or seven laminae. In the chiasma these individual strands do not all separate and interweave with those from the other side. Three bundles often penetrate four of the other nerve (Fig. 3), or three are separated by two of the nerve from the other eye.

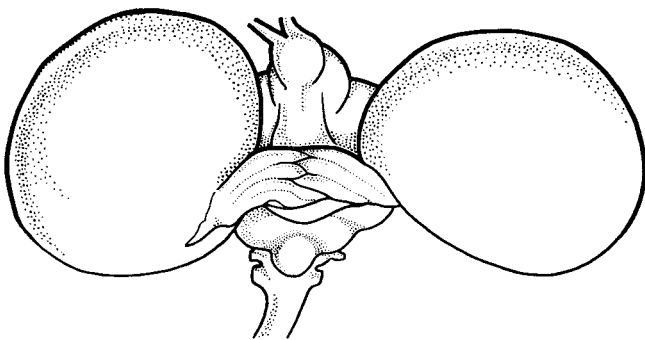

FIGURE 3. Frontal view of eyes and brain of an adult anchovy, showing the optic chiasma. Three bundles of the optic nerve from the right eye penetrate four bundles of the left nerve.

After the complete decussation in the interdigitating chiasma, the individual laminae of either side unite again where the optic tracts penetrate a thin bony capsule before entering the diencephalon. At this level we can see that the optic tract separates into two main portions, the tractus opticus dorsalis (medialis) and the tractus opticus ventralis (lateralis) (Fig. 4). The dorsal optic tract invades the fronto-dorsal portion of the optic tectum, whereas the ventral tract continues farther caudad and branches into

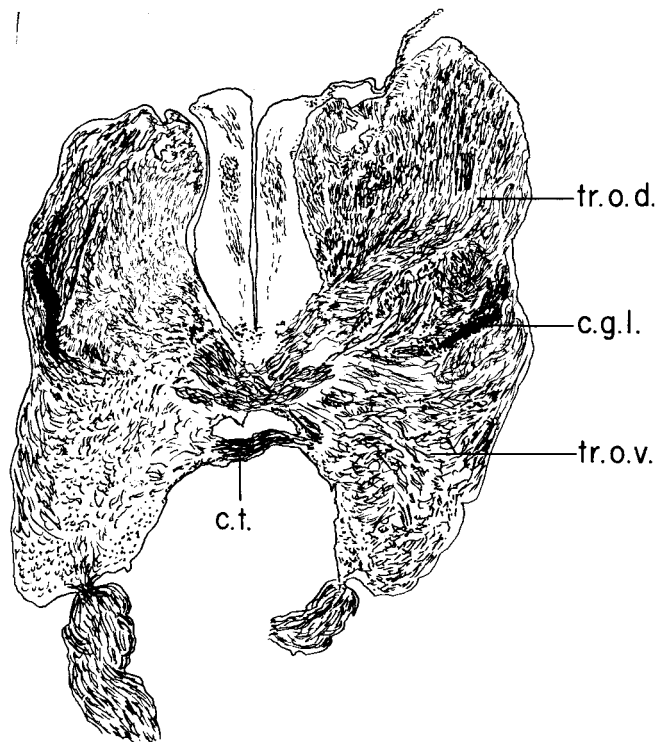

FIGURE 4. Transverse section through the brain of an adult anchovy at the level of the lateral geniculate nucleus (Bodian stain—30x). Tr. o. d.: dorsal optic tract; tr. o. v.: ventral optic tract; c. g. l.: lateral geniculate nucleus; c. t.: transverse commissure. The last bundle of the ventral optic tract passes through a thin bony lamella into the cranial cavity (constrictions).

the latero-caudal parts of the tectum. A small bundle branches off the dorsal tract medially and continues caudad where it joins the commissura minor. This is the fasciculus medialis nervi optici. (Bellonci, 1888; Kappers, 1906). The most lateral fibers form the fasciculus geniculatus tracti optici (Meador, 1934) and go to the corpus geniculatum laterale. Some apparently pass around this nucleus but many seem to terminate there, or form collaterals (Fig. 4). The geniculate fascicle is not clearly separated from the main dorsal tract, but its course can easily be observed for a certain distance by following this tract distally from its endings in the geniculate body.

The corpus geniculatum laterale is one of the most conspicuous optic centers and can be found throughout the vertebrate series. In mammals it becomes the relay station for visual impulses to the cortical representation area, and the tectal connection diminishes. In fish this center does not show the highly laminated structure that it does in some specialized mammals, although it can be folded in some (Franz, 1912). Franz could not identify the lateral geniculate body in *Ameiurus* and certain other bottom dwelling fish, but it is present in all teleosts with well developed vision.

In *Sardinops* and *Engraulis* the lateral geniculate extends very far rostrad, where all optic nerve fibers are still tightly grouped together, and it can be seen in the lateral wall of the dorsal optic tract as a thin lamella. A little farther caudad, its long axis which

was almost vertical changes to a dorsolateral-ventromedial direction (Fig. 4). The caudal portion of the lateral geniculate body is almost horizontally oriented. This nucleus consists of a very dense net of fibers intermingled with a few cells and enveloped by a layer of small cells. In sections, one can see that fibers of the geniculate fascicle stream predominantly into the ventral portion of the lateral geniculate body.

#### *Tectum opticum and torus longitudinalis*

In all fish which are equipped with good vision the optic tectum is a dominant part of the brain. As the name designates, the optic tectum covers the basal parts of the midbrain like a roof and receives visual information. Phylogenetically, it maintains this highly developed state through birds. In mammals, however, the tectum becomes reduced in relative size because of the greatly enlarged telencephalon; but, as superior colliculus, it probably retains the former reflex functions. Recapitulating phylogeny, the midbrain roof is found as a dominating part of the brain in the embryonic development of mammals. In teleost fish the optic tectum shows a greater differentiation in its fiber architecture than does any other part of the central nervous system.

The optic tectum has been studied extensively and can be divided into various layers. Ramon (1899) described ten strata, and, more recently, Leghissa (1955) distinguished seven layers which can be recognized in all teleosts. Beginning from the optic ventricle towards the surface, they are: 1) stratum griseum periventriculare, 2) stratum fibrosum profundum, 3) stratum griseum internum, 4) stratum plexiforme internum, 5) stratum griseum externum, 6) stratum

plexiforme et fibrosum externum, 7) stratum fibrosum marginale (Fig. 5).

Afferent fibers from retinal ganglion cells spread over the surface of the contralateral tectum. The course of these myelinated axons can be followed in the outer layers, the separation of which is not very distinct in sardine and anchovy. According to Leghissa (1955) retinal fibers of the dorsal optic tract are mixed with olfactory fibers of the strio-tectal tract in these layers. Optic terminal fibers curve sharply towards the inside where they synapse, mostly in the plexiform and fibrous layer, with dendrites of deeper situated neurons. Some fiber strands traverse the entire tectum obliquely from the superficial layer to the deep fiber layer. Leghissa (1955) claims that these fibers are efferent from the tectum and are axons from marginal neurons in the external plexiform and fiber layer. These fiber bundles are especially numerous in the more caudal portion of the tectum (Fig. 6). They join other fiber bundles in the deep fibrous layer, most of which course medially and cross over to the contralateral tectum as the fasciculus commissuralis intertectalis, or they have synapses in the contralateral torus longitudinalis.

The torus longitudinalis is a paired median structure which connects the tectal halves in the midline. Present in most teleosts, although rather small in some like anchovy and sardine (Fig. 5), the torus longitudinalis begins rostrally at the commissura posterior and becomes a paired structure caudally. At its anterior pole the torus can be seen to incorporate the fibers from the pars dorsalis of the posterior commissure (Fig. 7). Kudo's (1923) claim that axons of granule cells of the torus enter superficial tectal lay-

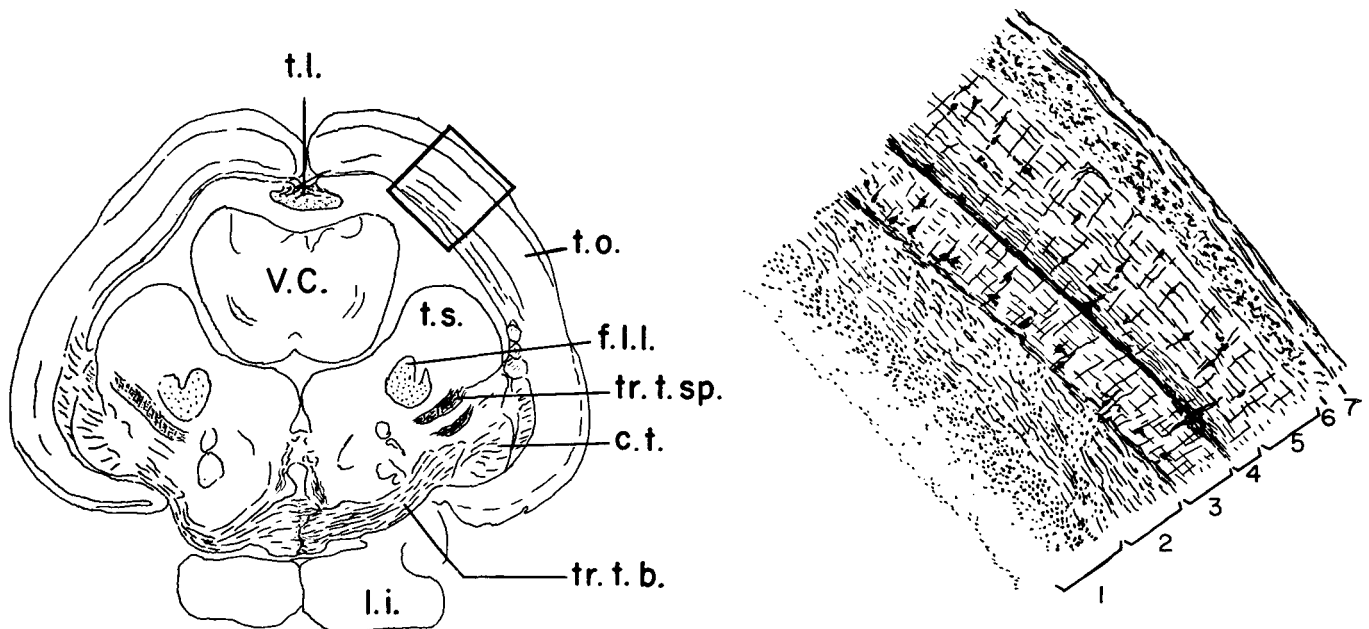

FIGURE 5. Transverse section through the midbrain of an adult anchovy, diagrammatically on the left (30x). Higher magnification of part of the optic tectum on the right (Bodian stain—100x). t.l.: torus longitudinalis; t.o.: optic tectum; t.s.: torus semicircularis; v.c.: valvula cerebelli; l.i.: inferior lobe of thalamus; f.l.l.: fasciculus longitudinalis lateralis (lateral lemniscus); tr. t. sp.: tecto-spinal tract; tr. t. b.: tecto-bulbar tract; c.t.: transverse commissure. Numbers 1 to 7 indicate the seven strata of the optic tectum.

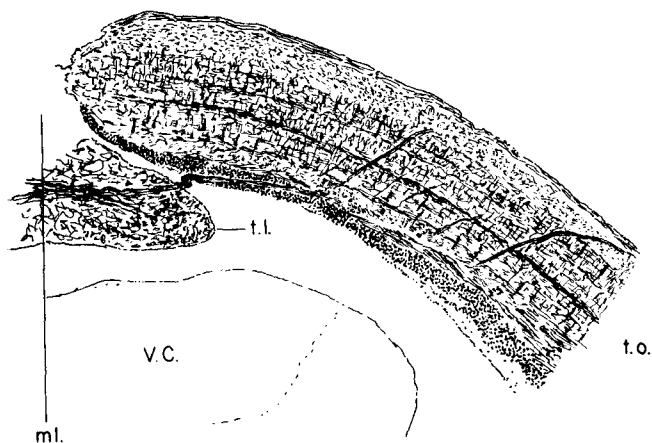

FIGURE 6. Transverse section through the optic tectum 550 micra farther caudad than Figure 5. (Bodian stain—50x). ml.: midline; other abbreviations see legend to Figure 5. Oblique bundles of fibers from layers 6 or 7 can be seen streaming into the efferent fiber layer.

ers, was disputed by Leghissa (1955). P. Ramon actually showed that axons of neurons in the torus enter the stratum opticum of the ipsilateral tectum (Ramon, 1899; Fig. 4). Our material does not show such connection. Axons of torus neurons form fiber bundles which stream rostrally and seem to leave the torus with the pars dorsalis of the posterior commissure. The connections of this dorsal part of the posterior commissure had been the cause of dispute (Kappers, Huber, Crosby, 1936, page 919). Leghissa (1955) describes part of the dorsal portion entering the tractus mesencephalo-cerebellaris anterior. The torus longitudinalis is a major visual center, interrelating visual

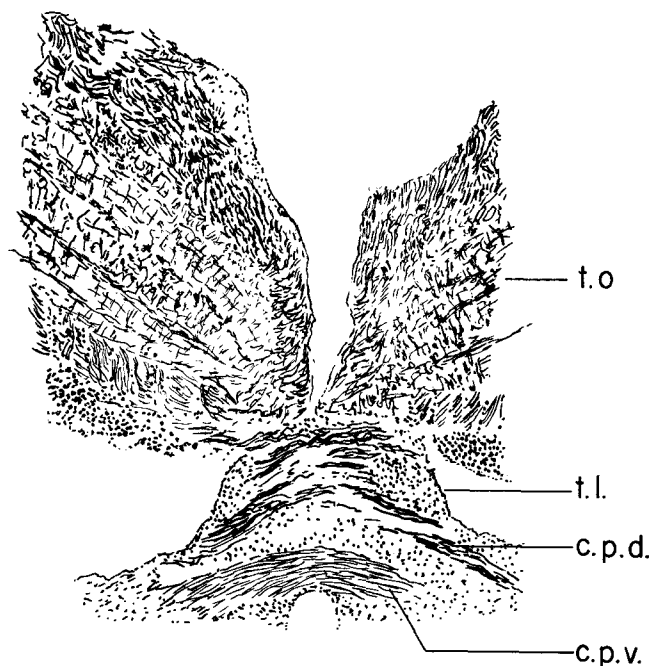

FIGURE 7. Transverse section through the anterior portion of the optic tectum (Bodian stain—100x), t.o.: optic tectum; t.l.: torus longitudinalis; c. p. d.: dorsal part of posterior commissure; c. p. v.: ventral part of posterior commissure.

information between the two lateral optic tecta, and may also play a role in correlating visual with gravistatic information, as suggested by the connection with the cerebellum.

There is extensive differentiation of efferent tracts. The tractus tectobulbaris is a large bundle which crosses as the commissura ansulata before proceeding to the medulla (Fig. 5). Another is the tractus tecto-spinalis which leads to the spinal cord. The commissura transversa receives tectal fibers, some of which connect to the ganglion isthmi.

**Other nuclei concerned with vision**

In addition to the geniculate body, the tectum opticum and the torus longitudinalis, there are several smaller nuclei situated in the basal mesencephalon and the thalamus. Almost all of these are concerned with relaying visual information because they have connections with the above three main centers and also with each other. Unfortunately, the nomenclature of these nuclei is in a disorderly state. Many apparently homologous structures were given different names by different authors and often the same name was applied to different structures (Kappers, Huber, and Crosby, 1936, page 925). We wish to mention only a few which are easily identified in our sections.

The corpus glomerulosum pars anterior (Franz, 1912; nucleus anterior thalami of earlier authors) lies caudal and slightly dorsal to the lateral geniculate (Fig. 8). It is connected with the latter and also with the tectum. A pars rotunda of this usually elongated corpus glomerulosum complex is absent in sardine and anchovy and apparently is missing in all physostomes which have been examined.



FIGURE 8. Transverse section through the right ventral midbrain and thalamus (Bodian stain—50x). t.o.: optic tectum; n.i.: nucleus intermedius; n.a.: nucleus anterior (corpus glomerulosum pars anterior); tr. o. v.: ventral optic tract.

Another optic relay station in close proximity to the geniculate and pars anterior of the glomerulosum complex is the nucleus intermedius (Goldstein, 1905; Brickner, 1929) which receives a loose bundle from the optic tract and also connects to the tectum and the geniculate (Fig. 8).

## DEVELOPMENT OF VISUAL STRUCTURES IN THE LARVA

An attempt was made to determine on which day after hatching visual structures make their first appearance. This was not easy because of the very small size of the larvae and because of the difficulty in staining the first fine nerve fibers. The larvae were hatched and reared at 18° C. All yolk sac larvae were *Sardinops*, the later stages *Sardinops* as well as *Engraulis*.

On the first day, the day of hatching, neurons are not yet differentiated; migration of neuroblasts in the mesencephalon has not begun. The lateral optic vesicles have formed a double layer and show the first signs of lens formation in their lateral walls. The cells in the lens placode are arranged spherically (Fig. 9). There is no differentiation of cells in the inner retinal layer of this secondary optic vesicle.

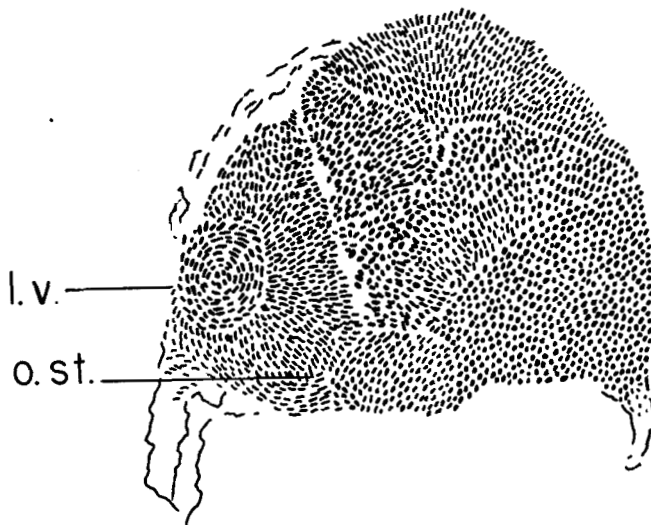

FIGURE 9. Cross section through the brain of a larval sardine on the day of hatching (Bodian stain—200x). l.v.: lens vesicle; o.st.: optic stalk.

On the second day (average length 4.93 mm) the eye is very advanced; pigment is present, visual cells are developed and the stratification of the retina into different layers is progressing (Fig. 10). At this stage no optic nerve fibers can be seen. The dorsal mid-brain shows a layer of nerve fiber endings; however, these may not be visual but somatic afferent. According to Leghissa (1955) the latter reach the tectum before retinal fibers. The gut of the two day old is still closed and yolk is present.

At three days of age (average length 5.27 mm) the cells of the bacillary layer in the retina have a greenish outer segment as in the eye of the adult fish. This probably indicates the presence of visual pigment. Optic nerve fibers leaving the eye and decussating with fibers from the other eye can be observed (Fig. 11). These visual fibers can be followed into the tectum where the fibrous layer now appears greatly enlarged. The foregut is opening in the three day old larva although the yolk sac has not been completely absorbed.

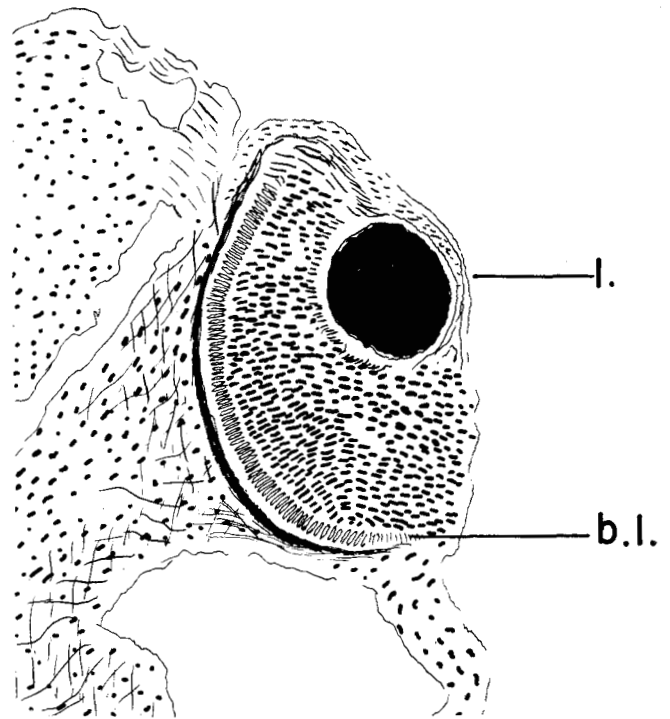

FIGURE 10. Cross section through the eye of a two-day old sardine (Bodian stain—300x). lens (l) and bacillary layer (b. l.) are well developed.

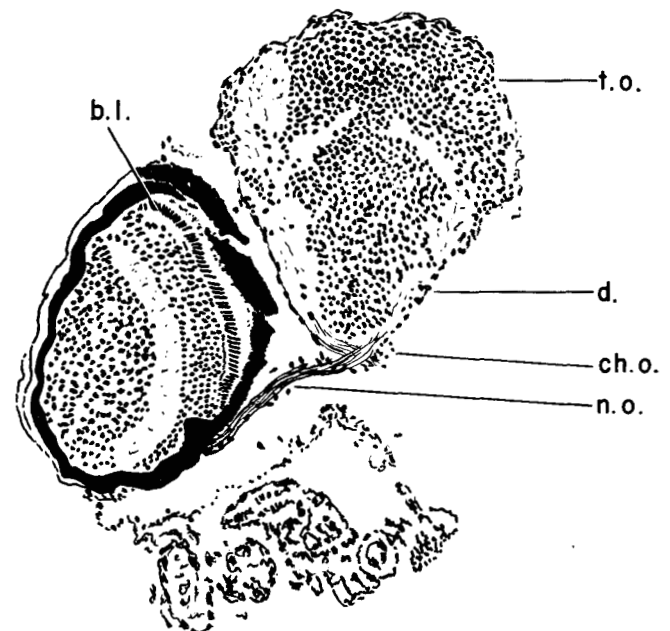

FIGURE 11. Three-day old sardine. Cross section through eye, thalamus and developing midbrain (Bodian stain—200x). b.l.: bacillary layer; n.o.: optic nerve; ch. o.: optic chiasma; d.: diencephalon; t.o.: optic tectum.

In the five day old larva (average length 5.56 mm), optic nerve fibers are well myelinated and appear yellowish-brown in Ranson-stained material (Fig. 12). In this section we can detect the first indication of an interdigitating chiasma. A small ventral bundle

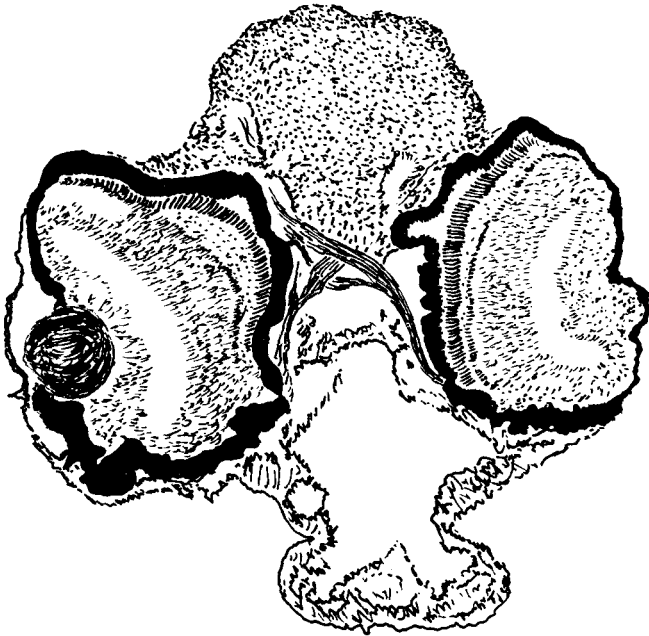

FIGURE 12. Five-day old sardine. Cross section through the head at the level of the optic chiasma (Ranson stain—200x). The optic nerve from the left seems to perforate the nerve from the right.

branches off the main part of the nerve and runs ventral to the nerve from the left eye. Retinal fibers can be easily followed in their course through the lateral portion of the diencephalon into the optic tectum.

The later development and differentiation of the visual system proceeds at a slower pace. The number of optic nerve fibers increases; the superficial part of the optic tectum becomes thicker as the different layers develop, whereas the underlying matrix of undifferentiated nerve cells decreases in size. This cellular layer is mostly concentrated dorsomedially where the torus longitudinalis will form. The torus longitudinalis appears in its final form relatively late, although fibers from the efferent fiber stratum connect the two tectal halves at an early stage. One of the earliest visual centers to develop is the lateral geniculate nucleus which can be detected in the five day old larva. However, the dense net of unmyelinated fibers inside this nucleus can be seen in later stages only.

### PHYSIOLOGICAL CONSIDERATIONS

Nerve fibers from retinal ganglion cells connect to the optic tectum in three day old larval sardines reared at 18° C. At this stage the young larva appears to begin feeding on its own; the yolk is almost absorbed and the foregut is opening. The eyes and connecting neural pathways are slowly assuming their important role in providing necessary information about the surrounding environment. An important question is how well the young larva is able to see with a visual system at such an early developmental state. There are about 40 individual fibers in the optic tract of the five day old larva and these fibers

terminate in a relatively small dorsolateral area of the contralateral tectum. It is known from experimental histological studies on the visual system of fish (Lubsen, 1921; Akert, 1949) that there is a topographic projection of the retina onto the optic tectum. In this work small lesions are made in different parts of the retina. The axons of destroyed ganglion cells degenerate, as do their myelin sheaths, and the degenerating myelin impregnates better with osmium salts than does normal myelin. The course of degenerating nerve fibers can subsequently be followed to an approximate location on the optic tectum. The details and the precision of this orderly projection have been worked out for several fresh water fish (Schwassmann and Kruger, 1965). Objects in the dorsal field of view which stimulate the ventral retina are projected to the medial portion of the contralateral tectum. The anterior visual field is represented rostrally on the tectum, whereas the posterior field can be detected in the caudal portion and the ventral field projects to the lateroventral portion. Receptive fields of individual ganglion cells were found to be very small (many less than four degrees) corresponding to an area of about one third of a millimeter in diameter on the retina of a 10 mm eye.

Obviously, true shape perception and good visual acuity depend on a precisely defined topographical projection of a great number of retinal axons onto the optic tectum. These requirements are certainly not fulfilled in the larva of only five days. The young sardine at the beginning of the feeding stage might be capable of a very coarse type of movement perception. Food particles might be detected by a partial shadowing effect on the eye, and their direction could be determined by alternate and simultaneous stimulation of both eyes.

Some indirect evidence that the precise retino-tectal projection is functional only at a later stage after feeding has already begun is found in Székely's studies with *Triturus* larvae (Székely, 1954). He exchanged different halves of the embryonic retinae resulting in a characteristic reversal of the corresponding visual fields which he noted by observing the feeding behavior. However, this reversal occurred only after the larva had been feeding normally for one week.

Only behavioral studies with young sardine larvae can provide information about the role of the early visual system in the detection and capture of food. The fact that the visual pathways and centers are operational toward the end of the yolk sac stage means that vision begins to play an important role in the life of the growing larva.

### ACKNOWLEDGEMENTS

I wish to express my thanks to Dr. George O. Schumann of the Biological Laboratory, United States Bureau of Commercial Fisheries at La Jolla, California for providing all of the larval material. Special thanks are extended to Miss Sharon Lee Ucker for the histological preparation of a large number of spec-

imens, to Suzanne Arlen for several of the drawings, and to Mrs. Marcia Herrmann and Miss Norma Jean Bodey for helping with the manuscript. I am indebted to Dr. Lawrence Kruger for providing laboratory facilities as well as funds for this study.

## REFERENCES

- Akert, K. 1949. Der visuelle Greifreflex. *Helv. Physiol. Acta* 7: 112-134.
- Bellonci, J. 1888. Ueber die centrale Endigung des Nervus opticus bei den Vertebraten. *Zeitsch. f. wissenschaft. Zool.* 47: 1-46.
- Brickner, R. M. 1929. A description and interpretation of certain parts of the teleostean midbrain and thalamus. *J. Comp. Neur.* 47:225-282.
- Franz, V. 1912. Beiträge zur Kenntnis des Mittelhirns und Zwischenhirns der Knochenfische. *Folia neuro-biol.* 6:402-441.
- Goldstein, K. 1905. Untersuchungen über das Vorderhirn und Zwischenhirn einiger Knochenfische, nebst einigen Beiträgen über Mittelhirn und Kleinhirn derselben. *Arch. mikr. Anat.* 66:135-219.
- Gross, J. 1903. Über die Sehnervenkreuzung bei den Reptilien. *Zool. Jahrb. Abt. Anat.* 17: 763-799.
- Kappers, C. U. Ariëns 1906. The structure of the teleostean and selachian brain. *J. Comp. Neur.* 16: 1-109.
- Kappers, C. U. Ariëns, G. C. Huber, and E. C. Crosby 1936. The comparative anatomy of the nervous system of vertebrates, including man. Repr. Hafner, New York, 1960. 3 Vols.
- Klüver, H. and E. Barrera 1953. A method for the combined staining of cells and fibers in the nervous system. *J. Neuropath. Exp. Neurol.* 12:400-403.
- Kudo, K. 1923. Contributions to the knowledge of the brain of bony fishes, *Proc. Kon. Akad. Wetensch.* 26: 65-78.
- Leghissa, S. 1955. La struttura microscopica e la citoarchitettura del tetto ottico dei pesci teleostei. *Zeitsch. Anat. Entwickl.* 118: 427-463.
- Lissner, H. 1923. Das Gehirn der Knochenfische. *Wiss. Meeresunters. Abt. Helgoland* 14:125-184.
- Lubsen, J. 1921. Over de projectie van het netvlies op het tectum opticum bij een beenvisch. *Nederl. Tijds. v. Geneesk.* 2: 1258-1261.
- Meador, R. G. 1934. The optic system of the teleost, *Holocentrus*. I. The primary optic pathways and the corpus geniculatum complex. *J. Comp. Neur.* 60: 361-407.
- Ramón, P. 1899. El lóbulo óptico de los peces. *Rev. trimestr. micrograf.* 4: 87-107.
- Ranson, S. W. 1911. Non-medullated nerve fibers in the spinal nerves. *Am. J. Anat.* 12: 67-87.
- Schwassmann, H. O. and L. Kruger 1965. Organization of the visual projection upon the optic tectum of some freshwater fish. *J. Comp. Neur.* 124:113-126.
- Solger, B. F. 1877. Über das noch nicht beschriebene Chiasma nervi optici von *Engraulis*, *Sitz. ber. Naturf. Ges. Halle.* 10-11.
- Ströer, W. F. W. 1939. Zur vergleichenden Anatomie des primären optischen Systems bei Wirbeltieren. *Zeitsch. Anat. Entwickl.* 110: 301-321.
- Székeley, G. 1954. Zur Ausbildung der lokalen funktionellen Spezifität der Retina. *Acta biol. Hung.* 5: 157-167.
- Weber, E. H. 1827. Beim Häring durchbohrt der Sehnerv des rechten Auges den des linken. *Meckel's Arch. Anat. Physiol.* 317.
- Ziesmer, Ch. 1952. Silberfärbung an Paraffinschnitten. Eine weitere Verbesserung der Bodian-Methode. *Mikroskopie* 7: 415-417.

## SOME ASPECTS OF BEHAVIOR IN CLUPEID LARVAE

GEORGE O. SCHUMANN

U.S. Bureau of Commercial Fisheries Biological Laboratory  
La Jolla, California

One of the most interesting phases of my project of rearing larvae of pelagic fishes has been the opportunity to investigate some aspects of theories proposed to explain peculiarities of feeding and high mortality among clupeid larvae. Owing to the marked decline of Pacific sardine (*Sardinops caerulea*) populations off the coast of California, particular emphasis has been placed on studying the larval history of this fish.

Sardine larvae can be placed into a natural assemblage of fish larvae possessing non-functional optic, oral, digestive and excretory systems at hatching. Food reserves in the form of egg-yolk are generally small in this group, and the larvae also seem to be exceedingly sensitive to largely undetermined environmental factors affecting survival during early larval life. In addition to pelagic larvae this group includes some larvae originating from demersal eggs of marine and freshwater species as well.

### LARVAL MORTALITY

One of the primary considerations in studies of clupeoid fishes, and particularly in studies on the Pacific sardine has been the elucidation of factors responsible for mortality of larvae during a period up to and including metamorphosis of larvae to the adult body form. As in all fish spawning large numbers of eggs, an enormous reduction in numbers of individuals occurs between the egg and adult. Although it was known long ago that mortality must be highest in the earlier life stages, it is only recently that anyone has attempted to learn just when and where in time this took place.

Early attempts at rearing the pelagic young of some marine fishes were for the most part futile, even though a quite comprehensive hatchery technology had been developed for rearing many species of freshwater fishes. Two of the earliest investigators of pelagic marine fish larvae, Fabre-Domergue and Biéatrix (1897), noted that small marine fish larvae being reared in aquaria died soon after the yolk-sac was absorbed and the tiny larvae became dependent upon the environment for nourishment. Because mortality was low or absent during embryonic, and the pro-larval stages, and high when the yolk reserve was exhausted and the larva began to search for food, some significance was attached to rate of survival during the first days of active life. This time of apparent extreme sensitivity to the environment was termed a "critical period." Later Hjort (1914, 1926) discussed a critical period concept whereby in general fish larvae were thought to have sensitive periods particularly in relation to their food supply.

Specifically, a "critical period" is thought to be a time when larvae are prone to markedly increased mortality over a short time span. "Short time" in this context may be a matter of several days to several weeks depending upon the species of fish and period in the life history. For instance, a "critical period" for sardine larvae reared in aquaria (although not definitely established for larvae in nature) may occupy a time interval of between several hours to several days, may occur more than once during larval life.

Attempts to study the rate of survival of various species of fish larvae in nature have proven difficult. Although much of our still inadequate information concerning survival has been drawn from studies of economically important freshwater fish populations, our knowledge of the details affecting survival of fish from the time of hatching to some early juvenile stage is fragmentary even for the most intensely studied and easily accessible freshwater fish species. It is not surprising, therefore, that although special interest and studies concerning the fate of pelagic eggs and larvae of various marine fishes took shape some 60 years ago, very little factual information is at hand on details concerning survival of larvae in the open sea.

One of the most informative studies on the survival of sardine eggs and larvae over the major portion of the distributional range, has been that of Ahlstrom (1954), whose Figure 32 (p. 138) is reproduced here as Figure 1. It may be seen that losses seem to be quite high between the final egg stage (hatching) and larvae of 3.25 and even 5.75 mm in length.

It would be of considerable importance to know precisely when losses took place because if mortality were actually high during a limited period of time, a few days after the yolk was absorbed, for instance, then the term "critical period" might have special biological significance. The factors causing mortality might then be sought in the physiology and particular food relations of larvae during the short time when they become wholly dependent upon external sources of nutrition and first subject to the stresses of an active life.

On the other hand, if losses were of a high but decreasing intensity over the first weeks of life, no one period could logically be considered as potentially more hazardous for sardine larvae than any other period. Mortality would then be a form of continuous environmental attrition removing a percentage of the larval population. Factors causing mortality might then be expected to be any or all normal dangers of life such as disease, predation, food supply and the like.

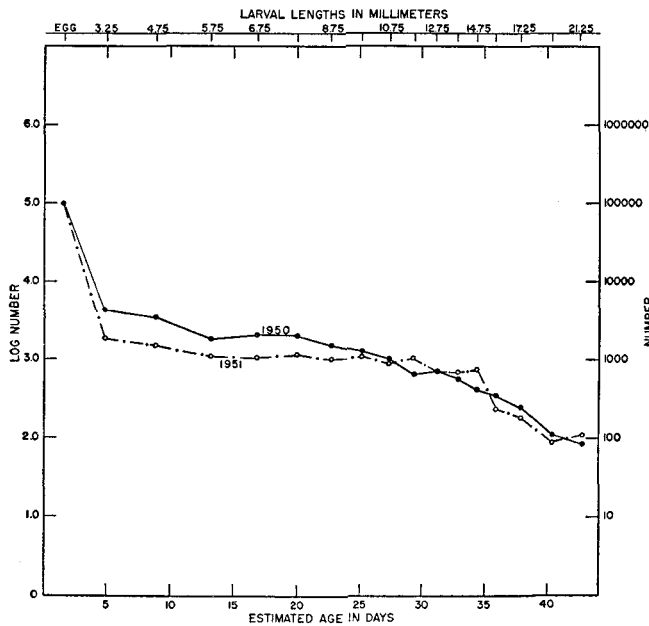

FIGURE 1. Survival of sardine larvae in the sea based on numbers of larvae in net samples (after Ahlstrom, 1954).

In discussing his Figure 32, Ahlstrom points out that although there seems to be an abrupt decline in numbers of larvae during the yolk-sac stages of development (when larvae are independent of external sources of nourishment), it is more likely the loss is an artifact resulting from the escape of very small larvae through the meshes of the net. Marr (1956), in discussing the significance of this loss (p. 167), mentions that evidence suggests only one-tenth of 3.25 mm sardine larvae encompassed by the net used by Ahlstrom were retained by the meshes. Figure 1 shows that rate of survival seems fairly constant from about the 5.75 mm stage of growth to at least 12.0 mm, therefore it may be assumed that the net had reasonably good retention of larvae from at least the end of the yolk stage, or by the onset of feeding (5.0–5.5 mm) in sardine larvae. If this assumption is reasonable then the numbers of larvae reported by Ahlstrom to be present at the 5.75 mm stage of growth may have represented the actual situation, while numbers reported present in the 3.25 to 4.75 (or 5.0) mm stage may in actuality have been far higher at one stage or another, meaning after Marr, that the magnitude of increase could be nine fold at any point. In other words, escapement may mask when any sudden reduction in numbers may occur and the severity of such reduction. In any event, there seems little reason to doubt that quite rapid decline in numbers does take place in sardine larval populations between two fairly reliable points of population estimation i.e., the egg and 5.75 mm stage. The recent paper by Isaacs (1964) and the discussion elsewhere in this symposium show that when all data are considered (70,000 sardine larvae from 10,000 plankton hauls over the years 1950 to 1957) there is a steep mortality curve for sardine larvae ending at approximately 5.75 mm–6.75 mm.

It is not the purpose of this paper to enter too deeply at this time into the specific question of whether or not "critical periods" do actually exist in nature during larval development, but rather to present some facets of larval behavior occurring during the first weeks of active life. On the other hand, some interesting though tentative observations on survival rate of "populations" of sardine larvae in large aquaria seem worth mentioning here, particularly in relation to Figure 1. A curve describing the mode of survival of 200 sardine eggs, pro-larvae and larvae up to 12 mm in length (Fig. 2) very closely approximates the curves in Figure 1.

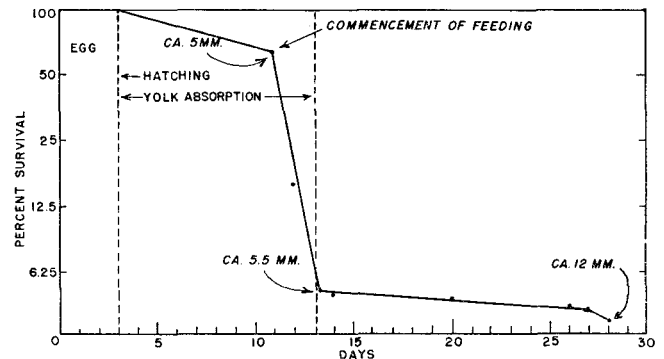

FIGURE 2. Aquarium experiment. Pattern of survival of 200 sardines at various stages of development.

In these aquarium experiments 200 sardine eggs of the same stage of development were allowed to hatch and a record maintained of daily losses in all stages of growth. Losses were very low or absent during the embryonic period; tests included a number of experiments with eggs collected at an early stage of development thus requiring about  $2\frac{1}{2}$  days to hatch (at  $16^\circ$ ), and eggs held for longer periods at low temperatures. Losses were also low or absent during the pro-larval stage (7 days), while nutrition was obtained from the yolk supply. Approximately at the point, however, when larvae began actively searching for food (5.0–5.5 mm) while existing on stored energy and body tissue, losses began to mount rapidly. Only in exceptional cases was survival during the next three days better than 10 out of about 200 pro-larvae. In several separate instances, after 5 or 10 larvae had survived to a size of approximately 5.5 to 6.0 mm in length, no further losses were experienced until about the 11–12.0 mm stage of growth (about 30 days after hatching), and a time when larvae seemed to be changing their feeding habits, when losses again were high.

Rearing experiments by Blaxter (1962) with herring larvae seem to indicate a pattern of survival comparable to that found for the Pacific sardine. After an initially high mortality upon complete yolk absorption, surviving herring larvae had a low mortality until a later period in development when mortality was again high. Blaxter's Figure 5, reproduced here as Figure 3, is particularly interesting in that the overall pattern of survival in each experiment changed little although the actual number of larvae surviving subsequent to hatching varied from 10 to 50 percent.



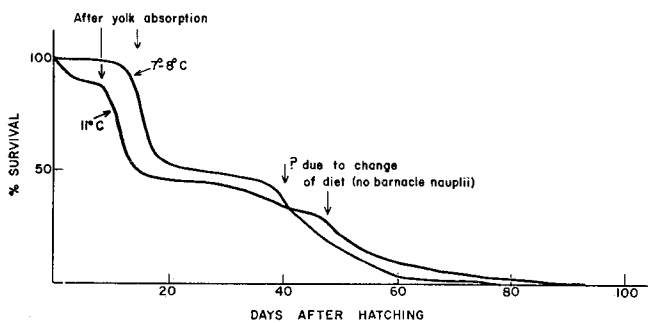

FIGURE 3. Aquarium experiments on survival of herring larvae at different temperatures (after Blaxter, 1962).

Ahlstrom's interpretation (p. 136-137) of his Figure 32 chooses between the seeming alternatives of a "critical period," or an artifact of net selectivity, to explain the abrupt decline between terminal egg and yolk-sac stages. Ahlstrom favored the latter explanation, but it seems at least possible, in light of the experimental results outlined above, that both conditions might apply. In other words, nets are not sampling the earliest larval stages accurately enough to detect a period of increased larval mortality just prior to the 5.75 mm stage of development, if, following Marr's (1961) conclusion that nine-tenths of the very earliest larval sardine stages escape through the meshes.

The curves showing survival in Figure 1, level off somewhat in the section reporting abundance of larvae between 5.75 and 11.75 mm in length, the 1950 curve not showing quite as pronounced a flat section. In commenting upon the more or less level sections in the curves, Ahlstrom noted that "this means, interpreted literally, that mortality during this period of life was negligible, after having been precipitous immediately following hatching. This does not seem reasonable. Net selectivity severest on newly hatched larvae [i.e., 5-5.75 mm larvae] and becoming progressively less severe with increase in larvae size, could produce a flat section of the curve." One might well ask why this type of survival is unreasonable, particularly in light of a similar "flat section" occurring in the rate of survival of clupeid larvae being reared under experimental conditions where predation of larvae was absent and the presumed main condition for larval survival was adequate quantities of food of the correct size and type.

Survival curves drawn from sampling at sea, and efforts at rearing sardine larvae are at present too incomplete to offer more than interesting parallels. However, it is in the small details of larval ecology and behavior—particularly the relation between the larva and its food organisms—that experimental rearing of pelagic fish larvae can aid studies on the same species of larvae in nature. For the period when feeding of larvae is governed by innate behavior, at least, it seems likely that normal behavior will be expressed whether the microcosm occupied by the larva be in the sea, or in an aquarium where it can be observed.

### INCIDENCE OF FEEDING

Examination of various species of clupeoid larvae seems to indicate that incidence of feeding is very

low (Lebour, 1921; Soleim, 1942; Arthur, 1956), in contrast to that of some flatfish (Scott, 1922), Cod, (Wiborg, 1948), and mackerel, (Lebour, 1920; Arthur, 1956). Theories on low incidence of feeding presume a number of factors being responsible for few clupeid larvae containing food in samples containing hundreds or thousands of specimens. The magnitude of the proportions—i.e. larvae containing food to those not containing food—as judged from tow net samples, is enormous in some species. For example, Berner (1959) found that in a sample of 13,620 anchovy larvae (*Engraulis mordax*) captured in the year 1954, only 211 contained food.

The chief artificial factor proposed to explain the low food content of captured larvae is that nets tend to selectively capture dead or dying larvae in disproportionate numbers, therefore low incidence of feeding may be an artifact of sampling (Arthur, 1956; Berner, 1959; Soleim, 1942). On the other hand, no one seems to have proposed an explanation of the cause underlying the natural occurrence of such quantities of dead or dying larvae in the plankton; Marr (1956) noted that poorly washed nets may have been contributory to such (artificial) occurrences in some cases.

Another possibility to which apparent low incidence of feeding could be ascribed, is that the majority of clupeoid larvae investigated come from samples taken at night when larvae are thought not to feed. It is possible that this objection is valid. However, Arthur (1956) noted that young sardine larvae of 5 to 6 mm in length contained about as much food at night as they did during the day, whereas older larvae containing food occurred only in samples collected during the day. This note is all the more interesting in light of observations of my own which suggest anchovy larvae of about 4 to 5 mm in length, hatched and reared out of doors in a 50 gallon aquarium, feed during the night or at least under very low light intensities. The larval hind-gut and frequently the mid-gut of the fish was filled with food organisms by 5:30 in the morning. The observed feeding frequency (the act of striking at food) indicated that the gut could not have been filled to the observed extent in the short period between dawn and time of observation.

As a general rule, however, we may assume that the majority of particulate feeding fish larvae will exhibit diurnal feeding habits, or at least have a higher food intake during the day than at night, and we may further assume that regardless of species more clupeid larvae will be collected at night than during the day. This also would hold true for most pelagic species, but even so, clupeid larvae seem to be noteworthy for the low number of individuals captured containing food.

Other theories accept low incidence of feeding among clupeoid larvae as a natural occurrence. Factors affecting low incidence of feeding include the possibility that food must be quickly digested and excreted because its presence in the gut would tend to make a transparent larva conspicuous and thus more subject to predation (Lebour, 1921). It is pre-

sumed that food is taken at long intervals and rapidly passed through the gut. Since the rate of digestion and gut clearance of sardine larvae has been established by Arthur (1956) at approximately 11 hours for 5.5 mm larvae and 3 hours for 10 to 25 mm larvae, the survival value theses of rapid digestion seems questionable, at least for sardine larvae. My experiments tend to confirm Arthur's data on the rate of gut clearance, although the rate of digestion of *Artemia* by sardine and anchovy (*Engraulis mordax*) larvae may vary from that for natural marine plankters. I have observed that an average of only 25 seconds is required by larvae of 15 mm in length or larger to pass an *Artemia* nauplius from the mouth to approximately one-half the length of the digestive tract (to a point just under the air bladder). Progress of a food particle (*Artemia*) through the remainder of the gut is much slower, with an average of two minutes required for food to reach the end of the gut and form a food plug.

The food of the jack mackerel (*Trachurus symmetricus*) has been found by Arthur (1956) to be substantially the same as that of sardine and anchovy larvae, but the ontogeny of the two body types and food capacities are very dissimilar. When they emerge from the egg, the jack mackerel is about 2 mm long and the sardine about 3 mm. Neither fish has functional eyes, mouth, or digestive system. Soon after the onset of feeding, (about 3.5 mm) the jack mackerel has developed a large head and capacious mouth. The sardine larva at this time is about 5.0-5.5 mm long and has a small head and mouth. The relative capabilities of the two types of oral apparatus may be seen in the progressive increase in food consumed by the jack mackerel larvae as compared to the anchovy, the latter being morphologically very similar to sardine larvae. Arthur notes (p. 95) that "at a length of 4.5 mm, the jack mackerel might contain about .004 cc of food. Assuming that the volume of the jack mackerel increases roughly by the cube of its length, then doubling its length would result in a body-volume increase of eight times; the volume of food, however, has increased about 200 times. The anchovy, while increasing in length from 4.0 to 7.0 mm theoretically increases in bulk by a factor of about 5.4 times. Its average food volume increases during this growth only by a factor of 1.25 times." It would seem, on the basis of these calculations, that low food intake may be a normal occurrence among clupeoid larvae, although low consumption does not rule out the possibility that the conversion of food to energy may be very high. Presumably the energy expended in hunting food is roughly similar in the two types, at least during early larval stages.

At onset of feeding, sardine larvae have been observed to spend only an average of 25 minutes per hour in motion, when food is captured, and an average of 35 minutes resting motionless in the water. The duration of each individual active or quiescent period lasted from roughly 30 seconds to 10 minutes, with a number of alternating active and quiescent periods occurring in one hour. It appears that there is a correlation between the length of time a larva had been

active and length of the succeeding quiescent period, i.e. the longer (or more energetic) the active period was, the longer the duration of the following quiescent period. Several explanations for this behavior seem feasible. The most intriguing conjecture concerns the effect of the metabolite level which presumably increases during activity and which must be reduced—possibly by diffusion—as the larva rests motionless in the water. Small (5-7 mm) larvae do not show evidence of a well developed vascular system. Thus it may be assumed that waste products of metabolism, along with oxygen, pass through the skin by simple diffusion. It is interesting to note, in this context, that erythrocytes or at least hemoglobin, indicating an increased role of the blood in oxygen transport develop first in the larva at metamorphosis when the skin becomes covered by scales and thus presumably impermeable to diffusion. The motionless-drift period may also be a time when food is digested and absorbed and energy is conserved.

The yolk is exhausted at the 4.5-5.0 mm stage of development and larvae exist on their own tissue and whatever food they capture. An average of two units of effort (a striking motion) per 25 minute active period, to capture food is the observed situation at onset of feeding for sardine larvae held in aquaria. It is not known, in every instance, whether or not larvae are successful at every attempt at feeding. A deficit may be acquired during the 25 minute average active period of one hour, which may be rectified by a double success in a succeeding active period. It should be pointed out, in any case, that the margin between life and death in sardine larvae at onset of feeding seems exceedingly narrow (Lasker, 1962).

This type of alternating active and resting behavior, which limits food intake of sardine larvae, but conserves energy, contrasts with feeding behavior of some other pelagic fish larvae equal or smaller in size to the sardine larva at onset of feeding. Various species of 2-3 mm flatfish larvae, for instance have been observed to move slowly but constantly through the water feeding at short intervals on organisms in their path. Presumably flatfish larvae acquire more food when rich aggregations are encountered, but expend more energy than do sardine larvae when food is widely dispersed. The young of the California flying fish (*Cypselurus californicus*), which hatch with an abundant food reserve, have been observed to swim continuously from the moment of hatching and to capture food (*Artemia*) while some yolk remained unabsorbed. Food is located by this fish, as in the large group of larvae from demersally spawned eggs, by traveling long distances in proportion to the body length. Most of the larvae in this group are physically, and probably physiologically, well developed at birth and rely less on chance—as does the sardine larvae at onset of feeding—to bring them into contact with food, than on their own swimming abilities.

One very interesting report concerning incidence of feeding raises some questions which observation on living material has been able to at least partially answer. Arthur (1956) states "Feeding incidence, when high, obviously implies . . . that a large percentage of

the fish larvae [in a net-tow sample] have been able to secure food. In other words, there is a relation between feeding incidence and the number of food particles per feeding fish, and the number of particles found in a larva should be related to its probability of securing a food particle during the digestive period. In one sample, 279 sardine larvae were captured, of which 200 had completed yolk absorption. Of these 200 potentially feeding larvae, 14 contained food and a total of 30 food particles were found in these 14 larvae. Using a Poisson type distribution for 30 particles scattered among 300 individuals, the expected number of larvae containing 0, 1, 2, and 3 particles was calculated. The expected number of particles becomes insignificantly low for 4 or more particles. The difference between the observed and the expected frequency distributions is that the actual larvae with food were fewer than the number calculated on the basis of chance, whereas the larvae with three or more particles were more numerous than calculated." Arthur goes on to say that "this may be explained by assuming that a larva that has captured one food particle has an increased probability of catching another within a unit length of time. Such a situation would follow if the larva is somehow conditioned by the first particle thereby increasing its efforts or ability to obtain a second or third particle." A second explanation of the disparity between the observed and the expected values within a sample was also discussed. The gist of Arthur's explanation is that it would be possible to capture with the same net, portions of two or more larval concentrations which had been living with dissimilar local plankton aggregations. This situation obviously implies a marked heterogeneity of plankton distribution within a small area.

Among the items of interest brought out by the above are 1) conditioning of feeding behavior, and 2) the problem of plankton dispersal, more specifically, the availability of food for sardine larvae.

### CONDITIONING OF FEEDING BEHAVIOR

In the first instance, if sardine larvae can be conditioned to further efforts by the capture of food, presumably they would also be liable to frustration upon repeated failure. Both premises are valid for some species of adult fish at least. Soleim (1942) described a conditioning of non-feeding behavior in herring (*Clupea harengus*), whereby the larva having failed to capture food after several attempts, gives up and ultimately dies. I have observed this behavior to occur at onset of feeding in sardine larvae, however, it is not entirely clear whether the fish experiences a loss of motivation, or simply exhausts its limited energy reserve, and in either case starves. Perhaps the stimulus provided by the act of capturing prey, or by food in the gut, engenders—or permits—further food getting activity.

A second assumption is that the larva increases its ability to obtain a second or third food particle; in other words, the larva learns to feed, becoming more proficient at recognizing, stalking and striking food organisms. Although learning undoubtedly occurs in

later larval stages it seems probable that for the earliest larval stages feeding behavior is a reflection of ontogenetic development of inherited instinctive behavior patterns.

Limited observations of sardine and anchovy larvae indicate the presence of behavior patterns which probably have some influence on larvae finding food. One such pattern was observed most often after a sardine larva (6-7 mm) had captured food, or had attempted to capture food. The larva seemed to engage in a pattern of "search" in which after moving a distance in one direction, a 90° turn to the right or left was made and an equal distance covered before turning 90° again in the same direction. Some larvae were observed to turn six times, though the usual number of turns seemed to be three or four. Anchovy larvae also appear to stay within an area where they have been successful in obtaining food, but a distinct "search" pattern has not been observed in larvae of 4-5 mm in length which had been reared in aquaria.

It seems possible that the presence of a "search" behavior in sardine larvae may account for Arthur's (1956) observation that among larvae containing food, each individual contained more food organisms than could be accounted for by chance. In other words, a larva that has captured one food particle would stand an increased probability of catching another if instinct caused it to hunt in the same area where food organisms were aggregated. This seems to be the case rather than the sardine larva being a randomly oriented predator operating on a randomly dispersed food supply.

The feeding reflex of sardine larvae, conditionable or not, does not begin immediately after the yolk sac is absorbed. The transition from yolk nutrition to feeding upon other organisms seems to be interspersed with a short period in which larvae subsist on the energy derived from body tissue. This is indicated by slight shrinkage in the length of the body. Presumably an adjustment is necessary in the visual, or some other organ system, because during this period a larva will move about periodically with slow undulations of the body, pausing now and then when it perceives small organisms nearby. Visual perception is assumed because a larva would occasionally recoil slightly and the head and eyes would move although no attempt would be made to feed. Usually the larva drifted motionless in the water for several minutes before becoming active again. The first active interest in food is seen when a larva apparently tries to focus on a particle in the water. The body is slightly drawn into an S-shaped position and the head is jockeyed back and forth in what seems to be an attempt to keep a moving particle within a very critical point of focus. Apparently the stimulus to feed is not always high enough at this period to cause the larva to strike at whatever it is that it perceives. Presumably the larva and the particle drift apart and visual contact is lost, or the feeding instinct is latent and there is a loss of interest in the particle. The larva may abruptly break off its inspection and lapse into motionless drifting, or move away. In following periods the sinuous position of the body becomes more pronounced, the head moves rap-

idly back and forth, and the first attempt to capture a particle is made. Only one lunge is made at a particle at onset of feeding.

Sardine larvae which are successful in their first attempts at feeding develop in later stages an obvious proficiency at capturing food. A food particle is sighted and struck in rapid succession. After the larva has reached 7 mm in length the broad swimming undulations are followed by short, rapid undulations as food is sighted. The head of the larva moves from side to side and the eyes are in constant motion as the body is drawn into a pronounced S-shape and a rapid strike is made. Each of these acts progress smoothly and the hesitancy seen during the first attempts at capturing food is no longer observed. One has the distinct impression that visual acuity is improving and that the larva can perceive movement of food organisms at a greater distance—presumably the head must still be brought very close to an organism, however, before it can be recognized as “edible”. As the larva grows in length, the rest periods become shorter and at about 9 mm the larva is in almost constant motion.

When *Artemia* ranging in size from newly hatched nauplii to several mm in length are introduced into a tank containing advanced sardine or anchovy larvae, it is at once apparent that larvae of about 15 mm in length obtain proportionally less food than larvae of 30 mm in length during the first few minutes of feeding. It is not primarily a question of fewer optimum sized *Artemia* being present that limits the food intake of the smaller fish, but it seems that smaller larvae still retain the early larval behavior of inspecting each food particle before eating or rejecting it. The larger larvae are at the point of metamorphosing to the adult body form and are possibly at the threshold of true filter feeding.

### HOMOGENEITY OF PLANKTON DISPERSAL

The second item of interest noted under “incidence of feeding” concerned the relation between the sardine larva and the distribution of plankton in the larva’s environment, and whether the potential food is uniformly dispersed or occurs in patches. This question is directly related to the availability of food, as opposed to the physical quantity present in a given volume of sea water. Present sampling methods tend to indicate the volume or mass of plankton present in a volume of water, but provide little information on micro-aggregations of organisms. In general, papers speculating on dynamics of larval marine fish populations equate numbers of invertebrate plankters with their availability as food, or, to put it another way, show that the ratio of larvae to food-mass is low, and therefore food is not of major significance to survival of larvae.

It seems evident from a perusal of the literature that the large volume of food organisms frequently associated with larvae in the contents of tow-net samples seems irreconcilable to the thesis that sardine, or other fish larvae may starve in the sea. The ratio of sardine larvae to potential food organisms has been calculated by Arthur (1956) who found a distinct

“surplus” of food organisms. Arthur calculated the distance between food organisms on the basis of numbers caught per volume of water sieved by the tow-net, and gave a mean distance between food organisms as 10 cm or less at 70 percent of his stations, and 7 cm or less at 50 percent of his stations. This would seem to lend credibility to the notion that food for larvae is abundant in the sea, or that, as observed by Murphy (1961) “because of motion of food and larvae, only a short time need pass before a [sardine] larva has a food organism within easy reach.” Random distribution of food is obviously assumed in this statement, because if an aggregation of food organisms were separated from a larva by only 20 cm, a great deal of time might pass before a 5 mm larva would find food within easy reach. The relative rates of drift for plankton aggregation and larva, in this circumstance, would be the same and even if the larva was disposed to swim four times its body length in one direction, there probably would be no clue as to the direction it must take to reach food. There is reason to believe, in fact, that 5 to 7 mm larvae are not capable of perceiving, or at least recognizing food organisms if they are more than a fraction of a millimeter distant. This statement is based upon many hours of observing larvae when they first attempt to feed.

During early stages of growth the larval sardine is incapable of much directed movement, thus if “chance of random encounter”, produced by macro- or micro-currents in the sea, was the sole, or major means of sardine larvae obtaining food, any biological or physical phenomena which hindered random distribution presumably would in like degree hinder or prevent larval fish from feeding. The real problem then, is to establish what the true conditions are in the sea; i.e. not whether mixing of sea water takes place but whether such mixing has any effect on the spatial distribution of organisms. We are again subject to the limitation of not having very much information on just how small crustacea and other potential food organisms react to various physical influences which would tend to disperse them. Numerous studies of predator-prey relationships, among other pertinent studies have pointed up the fact that randomness of distribution of either predator or prey is exceedingly rare in nature and regardless of the physical conditions imposed upon a population of organisms—whether bacteria or crustacea nauplii—aggregation rather than dispersal is the general rule. Although the sea may present a somewhat more uniform aspect than land, distribution of pelagic organisms is known not to be uniform with depth and, after a number of investigators, has also been found not to be uniform in a horizontal plane. Barnes and Marshall (1951) for instance, concluded that various copepod nauplii, lamellibranch larvae, and unidentified eggs were not distributed at random, except at low population densities, but had a contagious distribution. It is interesting to note that although copepod nauplii and lamellibranch larvae would be able to resist dispersal by

micro-currents, the unidentified eggs being non-motile, would not. Conceivably micro-currents, or convergences in the sea may be more liable to concentrate organisms or particles than they would be to disperse such material. Phenomena such as foam-lines and slicks, denoting concentrating rather than dispersing action, are frequent at sea.

At this point we are confronted by a very incongruous set of data. On the one hand a low incidence of feeding among clupeoid larvae seems to be well documented from many parts of the world. On the other hand, calculations of the ratio of plankters to larvae—indicate an abundance of food in the sea. In both cases, however, the contents of tow-nets were assessed to obtain the data.

A third incongruity is provided by observation of larvae held in aquaria under experimental conditions. Sardine and anchovy larvae ranging in size from 15 to 17 mm in length have been found to feed continuously on *Artemia* when these organisms are offered as food. Both species have been observed to completely fill the gut in about ten minutes and to have an initial mean feeding interval of 17 seconds, i.e. a strike by a larva at an *Artemia* nauplius was observed to result in its capture. When the gut is filled and some digestion has taken place, after about 30 minutes, feeding slows down to approximately one *Artemia* per minute as long as food is present. Larvae larger than 17 mm fill the gut in less time and capture food much more rapidly by gulping one or more *Artemia* in continuous feeding.

One may well wonder, however, if this is "normal" behavior, and whether it is representative of feeding behavior of larvae in the sea under comparable conditions of high food concentration. If it is natural for clupeoid, or at least sardine and anchovy larvae to eat as much as they can hold when food is readily available, then a re-evaluation of our methods of estimating the abundance of the available larval fish food biomass is in order.

Very little information is on hand to judge the actual availability of food organisms to larvae under natural conditions, but one important study points up the necessity of further investigation on this question. In his study of the relation between larval fish and food organisms, Arthur (1956) observed an unusual natural occurrence of sardine and anchovy larvae behaving like the larvae held under the experimental conditions noted above. In this instance Arthur reported (p. 96) that "approximately 36 sardine and 264 anchovy larvae were in this haul. Twenty-seven of the sardine and 41 of the anchovy larvae were 10.0 mm or longer. The *unusual* (italics mine) aspect of the sample is that most of the larger larvae of each species were literally crammed with pteropods." This sample was omitted from the list of food eaten, as Arthur reported "because the number of pteropods found in this one sample is larger than the total number of food particles found in the larger sardine and anchovy larvae of all other samples examined. . ." In my opinion, the sample should have been retained as a rare natural example of food aggregation and larval

feeding behavior. The natural biomass (pteropods) had, in this instance, very likely the same relative availability as the *Artemia* in the feeding experiments previously described, and the larvae which found themselves in this aggregation of pteropods ate to capacity.

The behavior of sardine and anchovy larvae, when one considers all aspects, seems intimately correlated to the behavior of the food organisms, indicating copepod behavior studies must be considered in conjunction with studies of larval fish ecology. Calculations of mean distances between food organisms may well represent only mathematical probabilities rather than biological actualities. The factors which influence fish populations cannot be viewed from the standpoint of all-encompassing equations, but rather must be studied as a series of minutiae which affect each individual step in the life history of fish from the egg to spawning adult. Each growth period or phase in the larval stage alone presents to the individual larva a new range of potentialities for success or disaster. My observations, limited as they are, indicate changes of survival tend to increase after the individual sardine has passed through one critical period at onset of feeding and very likely another period at about 11 to 12 mm in length. Thus agreeing in general with Marr's (1956) hypothesis that survival rate of sardine larvae increases at a nearly constant rate. Concomitant improvement in vision, the ability to range further in search of food, increased experience in capturing food, and the phasing in and out of certain behavior patterns throughout larval life all serve, to point up the large element of chance that determines life or death for sardine larvae at the critical onset of feeding. Probably at no other time in its life is the sardine so dependent upon the capture of food and so inadequately equipped to obtain it.

## REFERENCES

- Ahlstrom, E. H. 1954. Distribution and abundance of egg and larva population of the Pacific sardine. *U.S. Dept. Interior, Fish and Wildl. Ser. Bull.* 93: 83-140.
- Arthur, D. K. 1956. The particulate food and food resources of the larvae of three pelagic fishes, especially the Pacific sardine, *Sardinops caerulea*. Ph.D. Thesis, University of California, Scripps Institution of Oceanography, :231 pp. (Typewritten)
- Barnes, H. and S. M. Marshall. 1951. On the variability of replicate plankton samples and some applications of 'contagious' series to the statistical distribution of catches over restricted periods. *J. Mar. Biol. Ass. U.K.* 30: 233-263.
- Berner, L. 1959. The food of the larvae of the northern anchovy *Engraulis mordax*. *Inter-American tropical tuna Comm. Bull.* 4 (1): 3-22.
- Blaxter, J. H. S. 1962. Herring rearing—IV. Rearing beyond the yolk-sac stage. *Mar. Res. Scot.*, 1962, No. 1 18 pp.
- Fabre-Domergue, P. and E. Biétreix 1897. La periode critique post-larvaire des poissons marins. *Bull. Mus. Hist. Nat. Paris*, 3: 8-57.
- Hjort, J. 1914. Fluctuations in the great fisheries of northern Europe viewed in the light of biological research. *J. Cons. Explor. Mer.* 20: 1-228.
1926. Fluctuations in the year classes of important food fishes. *J. Cons. Explor. Mer.* 1 (1): 5-38.

- Isaacs, J. D. 1964. Night-caught and day-caught larvae of the California sardine. *Science* 144:1132-1133.
- Lasker, R. 1962. Efficiency and rate of yolk utilization by developing embryo and larvae of the Pacific sardine. *Sardinops caerulea*, *J. Fish. Res. Bd. Canada*. 19 (5): 867-875.
- Lebour, M. V. 1920. The food of young fish. No. 3, *J. Mar. Biol. Ass. U.K.* 12:261-324.
1921. The food of young clupeoids. *J. Mar. Biol. Ass. U.K.* 12: 458-465.
- Marr, J. C. 1956. The critical period in the early life history of marine fishes. *J. Cons. Int. Explor. Mer*, 21 (2) :160-170.
- Murphy, G. I. 1961. Oceanography and variations in the Pacific sardine population. California Cooperative Oceanic Fisheries Investigations. 8:55-64.
- Scott, A. 1922. On the food of young plaice (*Pleuronectes platessa*). *J. Mar. Biol. Ass. U.K.* 12: 678-687.
- Wiborg, K. F. 1948. Investigations on cod larvae in the coastal waters of northern Norway. *Fiskeridir. Skrifter Ser. Havunders.* 9 (3) : 1-27.

# THE FEEDING OF HERRING LARVAE AND THEIR ECOLOGY IN RELATION TO FEEDING

J. H. S. BLAXTER \*

Marine Laboratory, Aberdeen, Scotland

## INTRODUCTION

This contribution to the symposium consists of a review of published work and of new data obtained from recent experiments, some of which require confirmation. As material for study both dead larvae caught in plankton nets and live larvae reared in tanks have been used. It is difficult to catch live larvae by plankton net, but attempts to rear the Atlantic herring from the egg stage have met with more success than those on some other clupeoid species, thus providing interesting experimental material. Only brief consideration will be given to the feeding of herring larvae at the transition period from an internal yolk food supply to external sources and to concepts related to the "Critical Period" hypotheses, as this has been dealt with by Hempel in an earlier paper given to the symposium.

## THE FEEDING PROCESS

Larvae up to a length of 30 mm or more catch their food by a darting movement produced by an S-shaped flexure of the body. Smaller larvae may follow active food organisms over short distances in the S-shaped position, presumably by movements of the pectorals or primordial fin. Smaller larvae appear to sight possible food organisms when they are about 5 mm away and make the forward dart with the food about 2 mm from the head. After ingestion the food may be seen to pass rapidly to the posterior end of the gut where digestion takes place.

## NUMBERS OF FOOD ORGANISMS TAKEN

*Feeding incidence:* Herring larval surveys and analyses of gut contents have been especially done by European workers. The percentages of larvae caught with food organisms in the gut vary greatly. For instance Bowers and Williamson (1951) found values of 60–70%, whereas in other instances only small numbers or no larvae contained food (Lebour, 1921; Mielck, 1925; Marshall, Nicholls and Orr, 1937). Waldmann (1961) found that the incidence of feeding increased with size of larvae, but this might be deduced from the fact that older larvae have been presumably more successful at feeding and have a greater consumption. One reason for low percentages, apart from lack of suitable food, may be sampling at night. Hentschel (1950), for example, found that twenty times more larvae were found with food by day than by night. Another reason may be defecation

\* Present address: Natural History Department, Aberdeen University, Scotland.

under stress as Hardy (1924) observed in larvae kept in jars after capture. The present author saw larvae defecating under anaesthesia, but in tests to assess the effect of formalin on live larvae only about 10% of larvae were found to empty their guts during fixation.

*Numbers:* Some knowledge of numbers of food organisms taken is required to assess the food potential of an area and to estimate maintenance and growth requirements. The numbers found in those sea-caught larvae containing food vary greatly, depending on the size of the larvae and of the food organisms, quite apart from external factors such as time of day or artifacts such as the effect of capture. Hentschel (1950) gave the following average values:

Length of herring larvae	Copepods/larva	
	day	night
7–18 mm	0.72	0.21
18–30 mm	4.9	0.26
30–45 mm	5.9	0.41

Further values are summarized in Table 1. These are mainly instances of rather large numbers found in larvae which were feeding and not average values which may appear small due to a low incidence of feeding. The impression gained from the table, when comparing it with the percentage of larvae feeding and some instances of *average* number of organisms observed, is that herring larvae probably only rarely reach their capacity for ingestion. The feeding drive, the effect of satiation as studied in reared larvae and the concentration of food organisms in areas where larvae are caught are described in later sections.

## SIZE OF FOOD ORGANISMS TAKEN

It is necessary to know something of the capacity to ingest large and small organisms in order to estimate the relevant biomass in the plankton. In the young stages very small food organisms may be taken, for example *Coscinodiscus* about 0.15 mm across (Hardy, 1924). Larvae up to 18 mm will take *Tintinnopsis*, measuring about 0.08 x 0.07 mm (Hentschel, 1950) or *Mytilus* trochophores about 0.1 mm long (Blaxter and Hempel, 1961). Larvae up to 40 mm in length will still feed on *Artemia* nauplii about 0.4 mm long (Blaxter, new data).

The average size of food taken depends on the size of the larvae as nearly all the workers have shown in general terms. Hentschel (1950) provided the following, more detailed data:

	Carapace length of copepods eaten in mm				
	0.3	0.3–0.6	0.6–0.9	0.9–1.1	1.1
9–18 mm	7%	61%	32%	0%	0%
18–40 mm	2%	18%	75%	2%	4%

TABLE 1  
OBSERVATIONS ON AVERAGE AND ESPECIALLY HIGH NUMBERS OF FOOD ORGANISMS TAKEN BY HERRING LARVAE

Author	Length of larvae in mm	Organism	Number	Remarks
Bhattacharyya, 1957	14	<i>Limacina</i>	4.6/larva 62 in one larva	North Sea
Blaxter, 1962 new data	10-12 14-15	<i>Artemia; Balanus</i> nauplii <i>Artemia</i>	up to 10/larva up to 40/larva	Rearing experiments
Blaxter and Hempel, 1961	8-10 35	<i>Artemia</i> nauplii copepods	5-10/larva about 50 taken in 5 mins	Rearing experiments
Bowers and Williamson, 1951	6-10 10-15 >15	Gastropod larvae Gastropod larvae <i>Pseudocalanus</i> VI	4-10/larva 7/larva 3.6/larva	Irish Sea Irish Sea Irish Sea
Kurata, 1959*	<14	<i>Artemia</i> nauplii	5-11/larva 19 in one larva	Rearing experiments
Marshall, Nicholls and Orr, 1937	18.2 35	Crustacean eggs mixed copepodites	26.8/larva 69 in one larva + 26 other organisms	Clyde Clyde
Meyer, 1878			up to 20	Rearing experiments
Mielck, 1925	12-20	Small copepods?	up to 5	North Sea
Ogilvie, 1927	38, 41 35-40 -40-45 40+	<i>Pseudocalanus</i> VI Copepods Copepods Copepods	51 in each fish 27/fish 150/fish 479 in one fish	North Sea North Sea North Sea North Sea
Waldmann, 1961	16-25 26-35 36-45	"organisms" "organisms" "organisms"	2-3/larva 2-14/larva 2-60/fish	Baltic Baltic Baltic

\* *Clupea pallasii*, all others *Clupea harengus*

The maximum sizes of food organisms taken for different lengths of larvae, as compiled from the various authors cited so far, are shown in Figure 1. As very few authors measured the food organisms they observed, the main dimensions (total length of the body, breadth including the antennae turned back) are mainly taken from Wiborg (1948), although it is appreciated that there may be differences in the size of a copepod species as a result of temperature (Raymont, 1963).

There are exceptional instances of large organisms being taken, for example adult *Pseudocalanus* by a 6 mm larva and adult *Calanus* by a 19 mm larva (Bowers and Williamson, 1951). Adult *Pseudocalanus* are taken normally at lengths from 12 mm onwards.

In his detailed work on the size of food of other clupeoid larvae Arthur (1956) found that those of *Sardinops caerulea* took food up to 0.08 mm at a length of 4 mm and up to 0.2 mm at 10 mm; those of *Engraulis mordax* could take food up to 0.05 mm greater at any given length of the larva.

The gape of the jaws may be related to the size of food taken. In Figure 2 the vertical gape (assuming an angle of 60° between upper and lower jaw) is shown for samples of herring larvae at various stages living on their yolk reserves before active feeding commenced (from 6-11 mm). Clear differences may be seen between different races, as a result of the size of the original egg.

In Figure 3 the gape for herring larvae of various races still living on their yolk reserves is given re-

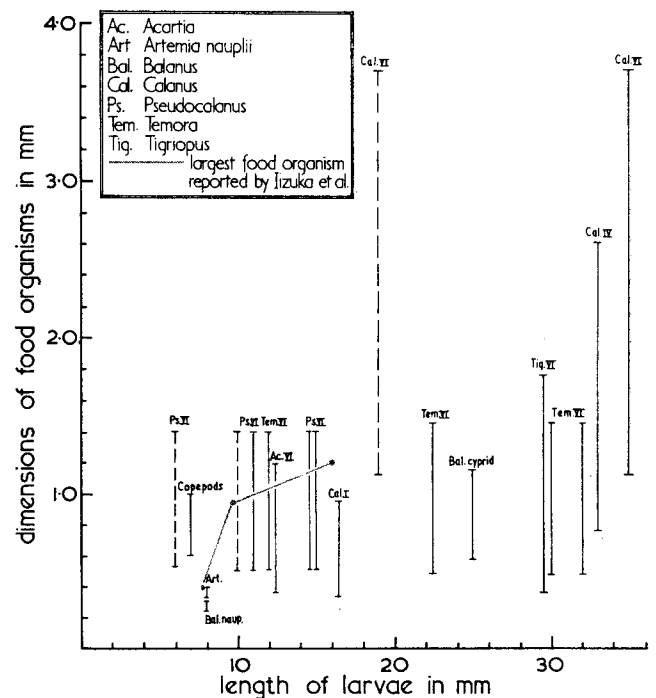

FIGURE 1. The dimensions of food organisms (total length and maximum breadth of body) reported by various authors to be taken by herring larvae.

--- normally taken  
— exceptional cases



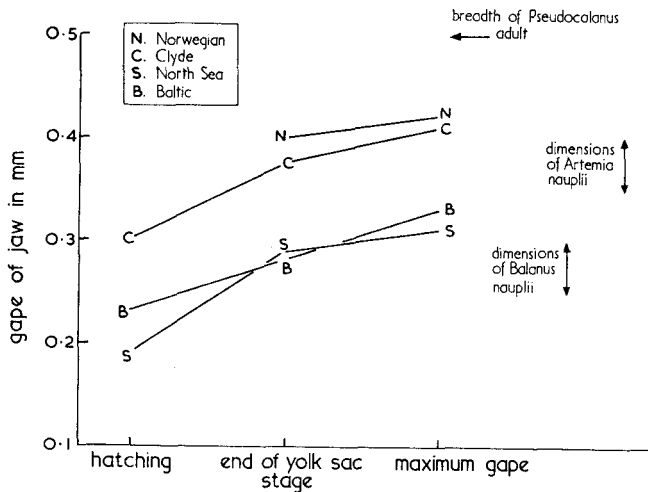

FIGURE 2. The vertical gape of the jaws of young herring larvae living on their yolk reserves, assuming an angle of 60° between the upper and lower jaw (using data from Blaxter and Hempel, 1963).

lated to length. In both figures the dimensions of the body (length and breadth) of *Artemia* and *Balanus* nauplii are given indicating that feeding on these sizes of organism might only just be possible. The racial differences in jaw gape could be of great significance. The reported cases of *Pseudocalanus* adults being taken at about 12 mm must mean that those organisms are taken "end on" and even then the gape would seem to be barely adequate. Recently Flüchter (1963) described an elastic ligament as the jaw articulation in herring larvae. This might enable large organisms to pass the restrictions of the articulation, but an instance has been found of a larva choked by taking too large a food organism.

Feeding is not only dependent on the size of the body of the food organism, but also on the nature of its appendages. Copepods are usually found taken with the antennae folded back along the body. This is probably not due to an intentional mode of feeding by the larvae. It is more likely that only organisms with their appendages folded in such a way

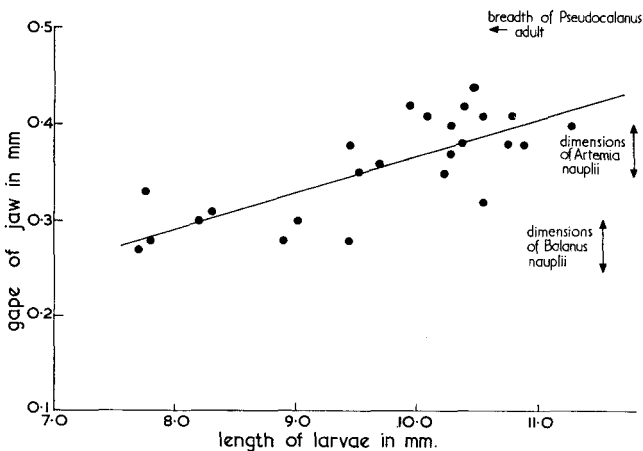

FIGURE 3. The vertical gape of the jaws of young herring larvae living on their yolk reserves related to length of the larvae (using data from Blaxter and Hempel, 1963).

during capture and approached from the right direction could be successfully fed on. Spiny organisms such as *Ceratium* might not pass through the mouth but presumably an ability to reject spiny objects might save the gut from being perforated.

**SELECTION OF FOOD AND RATE OF FEEDING**

Analyses of gut contents of herring larvae and also of the relevant zooplankton enable conclusions to be drawn about selection. The smaller larvae caught at sea most often contain copepod nauplii and eggs, mollusc larvae and some green food; at later stages copepodites and adult copepods, especially *Pseudocalanus* are found. Hardy (1924) inclined to the view that *Pseudocalanus* was selected and *Acartia* either ignored or rejected. Bowers and Williamson (1951) found that *Biddulphia sinensis* and *Ceratium* were not taken while *Acartia* occurred rarely in the guts in relation to its frequency in the plankton. Hentschel (1950) also found few *Biddulphia* but many *Coscinodiscus* in the gut when both were plentiful externally. Nauplii were not taken though they comprised 50% of the plankton; adult copepods, however, were predominant in the gut though comprising numerically only 6% of the plankton. Waldmann (1961) found a preference for *Eurytemora* compared with *Acartia* and few nauplii in the guts. More *Acartia* were taken than *Eurytemora* only when the ratio was 15:1 or greater in the plankton. Lishev, Rannak and Lisivnenko (1961) found that Baltic herring only fed on Rotatoria when copepods were scarce.

My observations show that herring larvae in tanks will take almost any kind of floating object ranging from their own faeces to bubbles on the surface, although they may rapidly adjust their initial selection after some experience of unfavorable food. Once an object is seized, secondary selection takes place within the mouth on the basis of taste and texture, as was shown in adult herring by Blaxter and Holliday (1958). For instance the larvae take fresh squid, but when it is soaked for 24 hours in sea water it is rejected. Live *Tigriopus* are retained but dead ones often rejected. Both live and dead *Daphnia* are also rejected, as are the eggs of herring, lemon sole and whiting, but not the connective tissue surrounding them.

The feeding drive may be weakened by experiencing unsuitable food, both at the initial selection and secondary selection stage. This drive also depends on the previous feeding history of the fish and weakens more rapidly with some types of food than others. In Figure 4 the number of pieces of squid flesh taken each minute by a group of eight larvae 22-40 mm long is shown after different periods without food. The effect of the time since last feeding is very variable but it seems that the first burst of feeding is at a high rate as long as the last feed was about five hours or more before. The rate drops rather rapidly with squid but picks up quickly if live *Tigriopus* are offered. The movement of *Tigriopus* seems to enhance the feeding drive as the number of organisms taken drops immediately when dead *Tigrio-*

pus are offered (Fig. 5). It should be remembered, however, that sea-caught larvae are often found with non-motile organisms, such as diatoms and copepod eggs, in the gut, so that movement of prey is far from essential to the feeding drive.

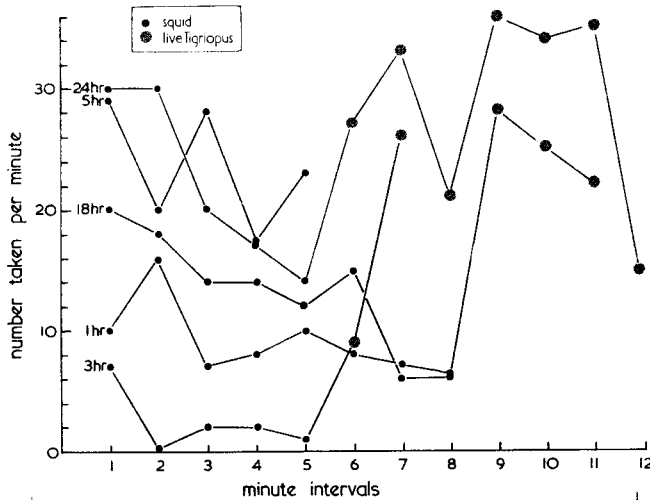

FIGURE 4. Number of pieces of squid flesh (weighing about 1.0 mg wet weight) and later live *Tigriopus* (wet weight about 0.5 mg) taken per minute by eight herring larvae 22-40 mm long after different periods without food at about 14° C. (new data)

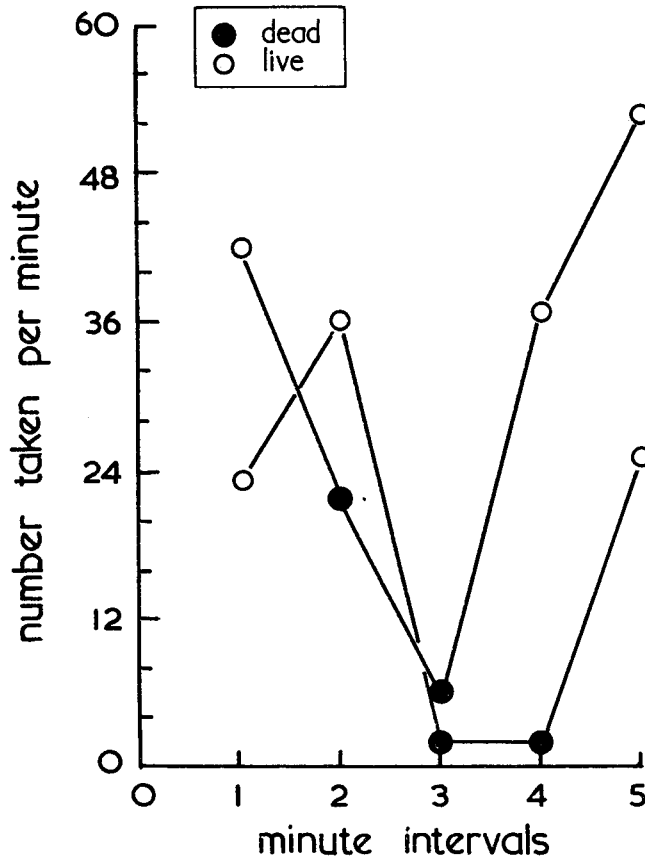

FIGURE 5. Number of live or dead *Tigriopus* (killed by drying, then soaked in sea water) taken per minute at a temperature of about 14° C (new data).

Arthur (1956), working on a restricted sample of *Sardinops caerulea* larvae, found that the distribution of food organisms in the guts was not random, but there were more larvae with a high number of food organisms than was expected by chance. He concluded that feeding might be enhanced in marginal food concentrations by the previous capture of an organism.

The rate of feeding may also be influenced by social factors. In rearing experiments size-hierarchy effects are apparent (Blaxter and Hempel, 1961; Blaxter, 1962). At the end of a period of two to three months after hatching the largest larva in a tank may be twice the length of the shortest, although abundant food has been offered and the larvae came from the same parents. While this may be partly due to differences in the ability to convert food, observations show that larvae may snap at each other, as well as compete actively for food.

DIGESTION

It has been suggested that digestion should be rapid in transparent larvae as an aid to remaining inconspicuous. The digestion time, defined as the time taken for the gut contents to become transparent, is given for different temperatures in Figure 6., based on tank observations and estimates from the study of gut contents of larvae caught at sea after dark. The time ranges from about 8 hours at 7°C to 4 hours at 15°C giving a Q<sub>10</sub> of 2.4. Arthur (1956) working on *Sardinops caerulea* found times ranging from 11 hours in larvae 5.5 mm long to 3 hours when 10-25 mm long.

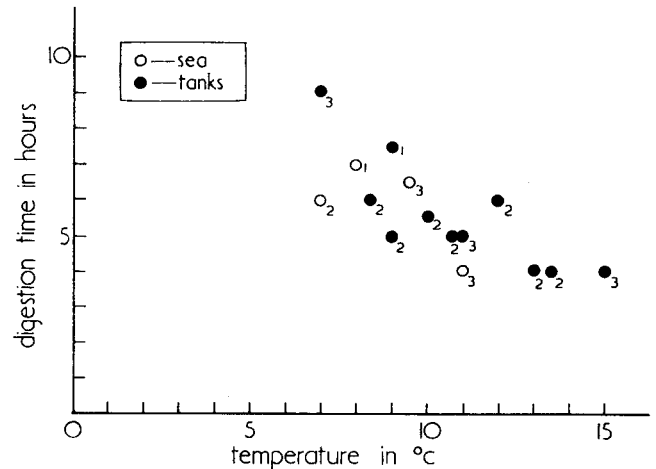

FIGURE 6. Time for digestion (taken as when gut contents become transparent) at different temperatures.  
 ○ Sea: 1. Hentschel (1950), 2. Hempel (unpubl.), 3. Bhattacharyya (1957).  
 ● Tank experiments: 1. Kurata (1957), 2. Blaxter and Hempel (1961), 3. Blaxter (1962).

The time for gut clearance depends much more on the feeding history of the larvae because feeding before or after a test feed can alter the rate of passage of food through the gut. Kurata (1959) gave the fol-

lowing figures for Pacific herring larvae 12 mm long held in tanks at 9°C.

Fed on 2-4 <i>Artemia</i> .....	12 h
Fed on 5-7 <i>Artemia</i> .....	15 h
Fed on 9-15 <i>Artemia</i> .....	19+ h

By feeding older larvae with squid flesh and using single feeds of *Tigriopus*, an orange copepod, as a marker, I found it possible to measure gut clearance by looking for the first signs of orange faeces. The time varied from 24-30 hours at 12°C if no food was given subsequent to the orange food.

**SOME CONSIDERATION OF NUTRITION**

Almost all authors who have studied the gut contents of herring have noted that food was taken before the yolk was resorbed. However, Schach (1939) found food in the gut only four days after resorption in rearing experiments. In the early stages green food remains have been reported by many authors (e.g. Hardy, 1924; Lebour, 1921, 1924; Ogilvie, 1927; Marshall *et al.*, 1937; Bhattacharyya, 1957) though it is not quite clear how often these are the results of secondary feeding, i.e. green food in the guts of zooplankton organisms taken as food. Schach (1939) and Blaxter and Hempel (1961) reared larvae to metamorphosis without green food being given while Soleim (1942) was of the opinion that green food was inadequate alone. The importance of dissolved organic matter (Pütter's Theory) has been discussed by Morris (1955), but evidence for the intake of such substances in marine fish larvae is still lacking.

*Artemia* nauplii have been used as a suitable food for rearing plaice larvae to metamorphosis (Shelbourne—this symposium) but Blaxter and Hempel (1961) were not successful in rearing larvae beyond a length of about 25 mm with *Artemia* alone; *Artemia* and wild plankton together produced better results. More recent experiments, given in Table 2, show a similar result.

**TABLE 2**  
**NUMBERS OF LARVAE REACHING DIFFERENT LENGTHS ON DIFFERENT DIETS (BLAXTER, NEW DATA)**

Tank	Number hatched	Number* reaching			
		15 mm	20 mm	25 mm	30 mm
1 Fed on <i>Artemia</i>	3166	715	24	2	--
2 Fed on wild plankton.....	2676	682	127	44	23

\* Corrected for larvae sacrificed.

Older larvae have been maintained, at least for a time, on chopped *Mytilus* (Dannevig, 1948) and squid (Blaxter—unpublished). No data are available on maintenance diets for herring larvae and their growth requirements, but experiments to determine these are in hand. The problems of making estimates when larvae cannot be kept singly in tanks, and when there is a fairly high, steady mortality, have to be solved.

**IMPORTANCE OF VISION**

The importance of vision in the life history of herring was reviewed by Blaxter and Holliday (1963). The feeding behavior of herring larvae and their prominent eyes stress the importance of vision in the early stages. This is supported by observations on the incidence of feeding in the sea by day and night (see later) and by preliminary experiments to measure the light intensity required for feeding in tanks. Larvae of 12-14 mm were dark-adapted in two black-walled tanks for at least two hours after a period of at least 12 hours without food. After dark-adaptation a given quantity of either *Artemia* or *Balanus* nauplii was put in the tanks. In one tank the overhead lighting was held at about 1000 lux while in the other the light was varied from experiment to experiment by means of neutral filters. The light intensity was measured at the surface, where the larvae feed, by a photo-multiplier unit (Craig and Lawrie, 1962) with a green filter giving a maximum sensitivity at about 510 mμ and calibrated against a standard light source in photopic lux. After one hour with food in the water a count was made in each tank to assess the proportion of larvae with food in the gut (this was easily seen as the guts are transparent). The proportion feeding after one hour in different light intensities was then expressed as a percentage of the proportion feeding in the control tank. The results are given in Figure 7, the threshold light intensity being taken when the proportion feeding in the experimental tank was half that in the control tank. The threshold using *Balanus* nauplii was 13 lux and for *Artemia* nauplii 0.3 lux; presumably the difference being due to the smaller size and greater transparency of the *Balanus* nauplii.

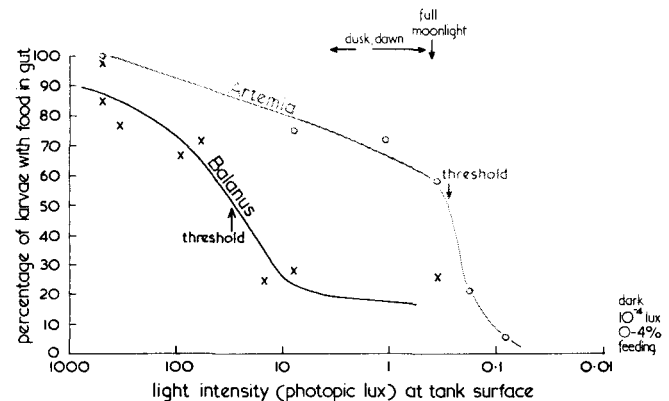

**FIGURE 7.** Percentage feeding on *Artemia* (o) and *Balanus* (x) nauplii fed at different light intensities in tanks (new data).

Initial studies of the histology of the eye of 8 mm and larger herring larvae (Jones and Blaxter—unpublished) show the presence of cones, but no rods have been demonstrated by the staining techniques to date. Their presence in larger larvae may be inferred from the density of nuclei in the "outer nuclear layer" (the layer containing the nuclei of the visual cells) which is much higher than the density of the cones. There are no signs of a foveal structure in the retina, al-

though there are some areas where the cones are especially dense. The size of the cones tends to increase with age of the larvae and the density decreases, as shown in Figure 8. The acuity of the eye, which is related to the reciprocal of the focal length and the density of cones (Tamura, 1957) will tend to be high in the young larvae as a result of the high density, but this will be offset by the small lens. In the older larvae the decrease in density and increase in size of the cones will tend to reduce the acuity, but this will probably be more than compensated for by the increase in size of the lens.

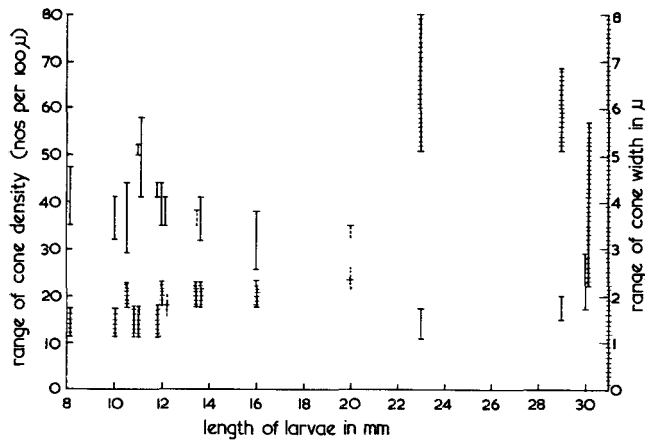

FIGURE 8. Density of cones (numbers/100 $\mu$  section) and width of ellipsoids in  $\mu$  for larvae of different length (Jones and Blaxter—new data).

Measurements on the pigment layer surrounding the retina in larvae adapted to different light intensities have as yet shown no clear trace of a photomechanical response whereby the more sensitive rods might become free of pigment at low light intensities. This pigment migration occurs in the adult and its onset appears at a larval length of about 30 mm, at a time when the main pigmentation of the body begins to be laid down. The main movement of the retinal pigment is at intensities from 10–1 photopic lux.

The position of the eyes of the larvae suggests that there is a degree of binocular vision which should facilitate the estimation of distance when catching food organisms.

### SUCCESS AND FAILURE IN FEEDING

Success and failure in feeding will depend on the searching power of the larvae, their ability to catch food and the abundance of suitable plankton.

*Searching power:* This may be defined as the distance covered by the larvae per day in search of food at times when the light is sufficient to make feeding possible. Light conditions are a limiting factor, for it has been shown that feeding does not occur at very low light intensities. This is confirmed by analyses of gut contents by day and night as shown in Figures 9a–d. Here the percentage of larvae with gut contents in three series of samples (Figs. 9a–c) is plotted against time of day, the hour of sunrise and sun-

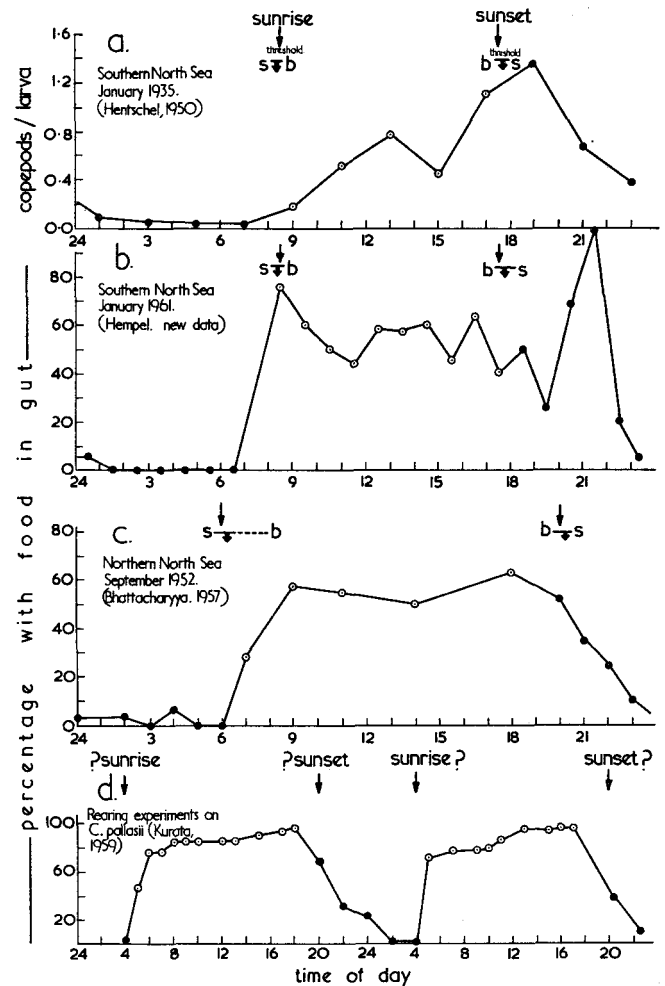

FIGURE 9a–d. Incidence of feeding at different times of day and night. a–c, sea caught larvae, d, rearing experiment. Times of sunrise and sunset are shown and related to the time when the threshold (taken as 1 lux) is reached at the bottom (B) and surface (S).

set and the approximate time when the threshold light intensity (taken as 1 lux) is reached at the surface and bottom. In Figure 9d the results of a 2-day feeding experiment in natural light conditions (Kurata, 1959) are given. All show how feeding falls off in the dark hours and from this a measure of digestion time can be obtained (given earlier). Observations made on light intensity in three areas and seasons, where spawning occurs and larvae are caught show how the time for searching may vary quite widely, by as much as 5 hours in 24 (Table 3).

Presumably larger and stronger larvae will have greater powers of locomotion and be able to cover greater distances within the daylight period. Bishai (1960) found that herring larvae 6–8 mm long could sustain a water current of 0.58–1.03 cm/sec for at least one hour, perhaps giving them the possibility of swimming 20–30 m in one hour. At an average cruising speed of 1 cm/sec and with a perception distance of 5 mm, a small larvae could search about 3 liters of water per hour. Blaxter (1962) showed that the maximum speeds of herring larvae range from about 3

TABLE 3  
TIME PER DAY FOR FEEDING OF HERRING LARVAE (10-20MM)  
BASED ON THRESHOLD LIGHT INTENSITY OF 1 LUX  
(BLAXTER, HEMPEL, NEW DATA)

Area	Month	Hours for feeding/day	
		Surface	Bottom
Southern North Sea.....	Mid-January.....	9.8	8.8*
Clyde.....	Mid-March.....	12.8	12.1
Northern North Sea.....	Mid-September.....	14.7	11.7†

\* In some shallow turbid areas (e.g. Sandettle) the light is never above threshold on bottom.

† Measurements were probably made in an area more turbid than average.

cm/sec for 8 mm larvae to 30 cm/sec for 20 mm larvae with a rather sudden increase in their abilities at a length around 15 mm when the caudal fin is formed. No data are yet available on the activity of herring larvae, except those of Woodhead and Woodhead (1955), who found differences in activity of newly-hatched larvae in relation to light intensity, which they related to vertical migration.

While certain factors such as swimming ability may increase searching power and other factors such as temperature or light or the feeding drive may influence activity and swimming, all these will raise the metabolic rate and therefore the food demands of the larvae. Holliday, Blaxter and Lasker (1964) found that the metabolic rate may increase up to ten times from the resting rate during periods of intense activity. It seems that in darkness activity drops, at least in tanks, the larvae moving slowly or sinking gently, and in this way food reserves may be conserved.

*Abundance of food:* Few estimates have been made of the food concentrations required for herring larvae and no correlations have been made between food available and larval mortalities, although Lishev *et al.* (1963) showed a relationship between relative numbers of Baltic herring "fry" (shortly after hatch-

ing) and the food supply from year to year. It seemed that larvae were four times more abundant in years when there were 20,000 food organisms/m<sup>3</sup> (copepod nauplii and copepodites) than when there were about 5500/m<sup>3</sup>. Waldmann (1961), by counting the gut contents of Baltic herring larvae showed, for example, in 1958, that 68,000 larvae 5-15 mm long would be required to take the plankton during one feed in 1 m<sup>3</sup> in May, or 64 larvae 36-45 mm long the plankton in 1 m<sup>3</sup> in July. From this and other data he concluded the plankton was adequate, as such concentrations of larvae were not found. Nikitinskaya (1958), working on Pacific herring larvae hatched in tanks, estimated that densities of 22,000 organisms/m<sup>3</sup> or a biomass from 20-50 mg/m<sup>3</sup> (? wet weight) were required for newly-feeding larvae to find sufficient food. In 1955 in the Sakhalin area such quantities were rarely found. Dementeva (1958) was of the opinion that food supply was not limiting for larvae of the Sea of Azov anchovy and Murphy (1961), considering Arthur's (1956) data on *Sardinops caerulea* larvae, found little evidence which suggested that food supply was limiting. In 70% of all stations the standing crop of food organisms was 1000/m<sup>3</sup> or greater, and in 50%, 3000/m<sup>3</sup> or greater. Taking a particular station with a high density of larvae as a guide, and making certain other assumptions, this gave a ratio of larvae to food organisms of 1:500 in 70% of stations and 1:1500 in 50%, suggesting very little competition for food. The mean distances between food organisms, assuming a random distribution, are given in Table 4 based on the work of these authors. The table shows that in instances where estimates have been made food seems to be abundant. If the distance between food organisms is halved to give a measure of the distance between a larvae and a food organism, it can be seen that in these particular surveys larvae had only very short distances to swim in order to meet food, up to about 5 cm, a distance they could swim in about 5 seconds or less without extending themselves. There are clearly res-

TABLE 4  
DISTANCES BETWEEN FOOD ORGANISMS

Author	Species of larvae	Species of food	Mean distance between food organisms (cm)	Remarks
Lishev <i>et al.</i> (1963)	Baltic herring	Copepod nauplii and copepodites	3-4 12-13	In years when larvae most abundant In years when larvae about ¼ as abundant
Waldmann (1961)	Baltic herring	nauplii <i>Eurytemora</i> <i>Acartia</i>	2-4.5 5+-16 5-7	Variations in years 1958-1959 between May and July—considered to be adequate
Nikitinskaya (1958)	Pacific herring	not given	3-4	Considered adequate density for newly-feeding larvae
Murphy (1961) using Arthur's (1956) data	<i>Sardinops caerulea</i>	nauplii	7 or less 10 or less	In 50% of stations ratio of larvae to food 1:1500 In 70% of stations ratio of larvae to food 1:500



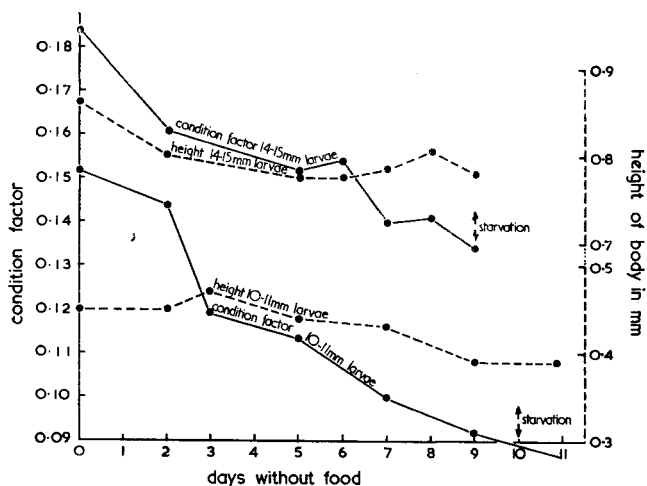

FIGURE 12. The condition factor and body height of herring larvae held in sea water tanks without adding food. Larvae of 10–11 mm had been living on yolk reserves, larvae of 14–15 mm had been feeding on *Artemia* and *Balanus* nauplii (from Blaxter and Hempel, 1963 and new data).

serious source of error in larval surveys for moribund larvae will quickly sink to the bottom. The condition factor and body height of some samples of herring larvae taken in the Clyde from 1959–1961 are shown in Figure 13 a and b. (Hempel and Blaxter, 1963 and new data). Also shown are the condition factor and body heights of larvae near starvation in tanks. The condition factors are much higher in the early stages up to 10 mm, presumably due to remnants of yolk reserves within the body (larvae with yolk sacs were not used), but they fall to a lower level between 10 and 15 mm and then rise again as a result of allometric growth and the formation of skeletal structures. Thus comparisons of condition factor, and of height, from year to year, need to be made within restricted length ranges. If this is done it can be seen that there is a tendency for the 1959 condition factor to be low and those of 1960 to be higher. What is of interest is that both in terms of condition factor and height the 10–11 mm larvae seem to be rather near the starvation point. At 14–15 mm they appear to be in very poor condition—unless the growth of larvae in tanks is abnormal giving high condition factors and body heights at starvation. Obviously this work, which is only in progress, requires confirmation. Data over a series of years are especially required, covering both the condition of the larvae and the available plankton. Further measurements are also needed on larvae reared in tanks and spurious factors in the measurement of condition factor and body height, such as shrinkage and differences in water content, need to be allowed for.

From the foregoing it would seem that in some areas covered, such as the Clyde (and also the southern North Sea), studies on the larvae and knowledge of the plankton suggest a fairly strong influence of availability of food on larval survival. Not only is the plankton scarcer but the hours for feeding are also less. The somewhat greater size of the winter-

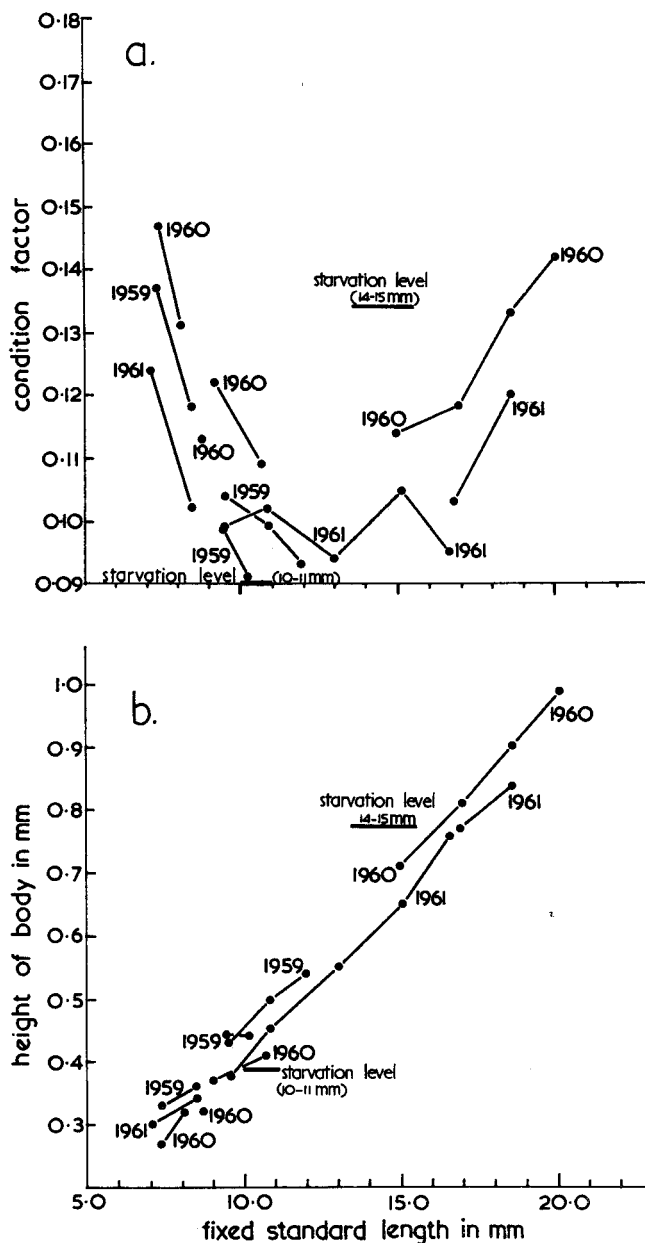

FIGURE 13. a. Condition factor; b. body height of herring larvae of different length caught in the Clyde in the spring 1959–1961 with estimated values at starvation (from Hempel and Blaxter, 1963 and new data).

and spring-spawned larvae may well have considerable adaptive significance. In the Baltic, at a later season, food might be less limiting (Waldmann, 1961) and here the larvae are smaller at hatching.

REFERENCES

Arthur, D. K. 1956. The particulate food and the food resources of the larvae of three pelagic fishes, especially the Pacific sardine, *Sardinops caerulea*. Ph.D. Thesis, University of California, Scripps Institution of Oceanography, : 231 (Typewritten).

Bhattacharyya, R. N. 1957. The food and feeding habits of larval and post-larval herring in the northern North Sea. Mar. Res. Scot. No. 3: 14 pp.

- Bishai, H. M. 1960. The effect of water currents on the survival and distribution of fish larvae. *J. Cons. int. Explor. Mer*, 25: 134-46.
- Blaxter, J. H. S. 1962. Herring Rearing—IV. Rearing beyond the yolk sac stage. *Mar. Res. Scot.*, No. 1: 18 pp.
- Blaxter, J. H. S. and G. Hempel 1961. Biologische Beobachtungen bei der Aufzucht von Heringsbrut. *Helgoländ. Wiss. Meeresunters.*, 7: 260-83.
- Blaxter, J. H. S. and G. Hempel 1963. The influence of egg size on herring larvae, *J. Cons. int. Explor. Mer*, 28: 211-40.
- Blaxter, J. H. S. and F. G. T. Holliday 1958. Herring (*Clupea harengus* L.) in aquaria.—II. feeding. *Mar. Res. Scot.*, No. 6: 22 pp.
- Blaxter, J. H. S. and F. G. T. Holliday 1963. The behaviour and physiology of the herring and other clupeoids. In "Advances in Marine Biology" Vol. 1, Ed. F. S. Russell. Academic Press, London and New York: 410 pp.
- Bowers, A. B. and D. I. Williamson 1951. Food of larval and early post-larval stages of autumn spawned herring in Manx waters. *Rep. mar. biol. Stat. Pt. Erin*, 63: 17-26.
- Craig, R. E. and R. G. Lawrie 1962. An underwater light intensity meter. *Limnol. Oceanogr.*, 7: 259-61.
- Dannevig, A. 1948. Rearing experiments at the Flødevigen sea fish hatchery 1943-1946. *J. Cons. int. Explor. Mer*, 15: 277-83.
- Dementeva, T. F. 1958. Methods of studying the effect of environmental factors on the fluctuations in abundance of the Azov anchovy. *Trudy V.N.I.R.O.*, 34: 30-62.
- Flüchter, J. 1962. Funktionsanatomische Untersuchungen am Kieferapparat der Heringslarven. *Kurz. Mitt. Inst. Fischereibiologie Hamburg*, 12: 1-12.
- Hardy, A. C. 1924. The herring in relation to its animate environment. Pt. I. The food and feeding habits of the herring with special reference to the east coast of England. *Fish. Invest. Lond., Ser II*, 7 (3): 53 pp.
- Hempel, G. and J. H. S. Blaxter 1963. On the condition of herring larvae. *Rapp. Cons. Explor. Mer*, 154: 35-40.
- Hentschel, E. 1950. Die Nahrung der Heringslarven. *Helgoländ. Wiss. Meeresunters.*, 3: 59-81.
- Holliday, F. G. T., J. H. S. Blaxter and R. Lasker 1964. Oxygen uptake of developing eggs and larvae of the herring (*Clupea harengus* L.) *J. mar. biol. Ass. U.K.*, 44: 711-23.
- Iizuka, A., S. Mikami and M. Tamura 1962. Studies on the early life history of herring *Clupea pallasii*. 2. On the growth and survival of larvae in Akkeshi Bay, Hokkaido. *Bull. Hokkaido Reg. Fish. Res. Lab.*, 25: 1-10.
- Kurata, H. 1959. Preliminary report on the rearing of the herring larvae. *Bull. Hokkaido Reg. Fish. Res. Lab.*, 20: 117-38.
- Lebour, M. V. 1921. The food of young clupeoids. *J. mar. biol. Ass. U.K.*, 12: 458-67.
- Lebour, M. V. 1924. The food of young herring. *J. mar. biol. Ass. U.K.*, 13: 325-30.
- Lishev, M. N., L. A. Rannak and L. N. Lisivnenko 1961. Condition of the Baltic herring stock in north-eastern Baltic and Gulf of Riga. *I.C.E.S. Baltic-Belt Sea Committ*, Paper No. 124 (mimeo).
- Marshall, S. M., A. G. Nicholls and A. P. Orr 1937. On the growth and feeding of the larval and post-larval stages of the Clyde herring. *J. mar. biol. Ass. U.K.*, 22: 245-67.
- Mielck, W. 1925. Heringslarven, Eier und Larven anderer Fische und Nahrung der Larven in der westlichen Nordsee im Oktober 1922. *Ber. dtsh. Komm. Meeresforsch.*, 1: 209-46.
- Morris, R. W. 1955. Some considerations regarding the nutrition of marine fish larvae. *J. Cons. int. Explor. Mer*, 20: 255-65.
- Murphy, G. I. 1961. Oceanography and variations in the Pacific sardine population. *California Cooperative Oceanic Fisheries Investigations*, 8: 55-64.
- Nikitinskaya, I. V. 1958. On the onset of active feeding of the larvae of *Clupea harengus pallasii* Val. (In Russian) *Zool. Zh.*, 37: 1568-71.
- Ogilvie, H. S. 1927. Observations on the food of post-larval herring from the Scottish Coast. *Rep. Fish. Bd. Scot.*, No. 1: 10 pp.
- Raymont, J. E. G. 1963. "Plankton and productivity in the oceans." Pergamon Press, London and New York: 660 pp.
- Schach, H. 1939. Die künstliche Aufzucht von *Clupea harengus*. *Helgoländ. Wiss. Meeresunters.*, 1: 359-72.
- Soleim, P. A. 1942. Årsaker til rike og fattige årganger av Sild. *Fiskeridir. Skr. Havundersøk.*, 7(2): 39 pp.
- Tamura, T. 1957. A study of visual perception in fish, especially on resolving power and accommodation. *Bull. Jap. Soc. Sci. Fish.*, 22: 536-57.
- Verheijen, F. J. 1959. A peculiar nystagmus and a corresponding foveal structure in the eye of the herring (*Clupea harengus* L.), *Experientia*, 15: 443-4.
- Waldmann, J. 1961. Untersuchungen an Heringslarven und Zooplankton des Greifswalder Boddens in den Jahren 1958 und 1959. *Zeit. Fisch. Hilfswiss.*, 10: 523-36.
- Wiborg, K. F. 1948. Experiments with the Clarke-Bumpus plankton sampler and with a plankton pump in the Lofoten area in northern Norway. *Fiskeridir. Skr. Havundersøk.*, 9 (2): 32 pp.
- Woodhead, P. M. J. and A. D. Woodhead 1955. The reactions of herring larvae to light; a mechanism of vertical migration. *Nature, Lond.*, 176: 349-50.



# OSMOREGULATION IN MARINE TELEOST EGGS AND LARVAE

F. G. T. HOLLIDAY

Natural History Department, Aberdeen University  
Aberdeen, Scotland

The fact that the eggs and larvae of some marine teleosts can survive and develop in sea water with a very low salt content was established by investigators such as Ford (1929) who incubated herring eggs in a salinity of 4.8‰, and Johansen (1908) who reported newly hatched plaice larvae living in 7‰ in the Baltic. It has also been found that the larvae of some marine fish, for example the clupeids and the rockling, can tolerate salinities considerably greater than sea-water. Battle (1930) reared *Encheilyopus cimbrius* in a salinity as high as 70‰. Kurata (1959) found that the yolk sac larvae of *Clupea pallasii* could tolerate 59.5‰ for 24 hours, and Holliday & Blaxter (1960) found that the same stage of *Clupea harengus* could tolerate 60.1‰. The ability to survive in extremes of salinity was apparently based on the actual tolerance by the embryonic tissues of a change in their water content, coupled with the ability of the developing organism to regulate, at least to some extent, the osmotic concentration of the tissues and tissue fluids.

Among the questions posed by these findings were

- (a) Is this ability found in a wide range of species, and does the age and condition of the fish affect its ability to survive in different salinities?
- (b) How extreme are the changes in water content and are they at the cellular or extracellular level?
- (c) Where are the sites of regulation, and how much does it 'cost' the organism metabolically?

A research program designed to investigate some aspects of these problems is at present being pursued on three species, the Atlantic herring (*Clupea harengus*) the plaice (*Pleuronectes platessa*) and, to a lesser extent, the cod (*Gadus callarias*). These species differ in their adult distribution, spawning habits and developmental pattern. All three are commercially important and two at least have been the subject of hatchery and farming experiments (see Shelbourne et al. 1963 and Bibov, 1960), and basic information on their physiological capabilities is desirable from this point of view.

Much of the material for this work was supplied by, and some of the work done in collaboration or close association with, J.H.S. Blaxter (Aberdeen), A.B. Bowers (Isle of Man), G. Hempel (Hamburg) and J.E. Shelbourne (Lowestoft), and I am grateful to them for the material and for stimulating discussions of the work.

## MATERIAL AND METHODS OF INCUBATION

Herring eggs were obtained from autumn spawning fish of the Scottish east coast, and from spring spawning fish of the Scottish Clyde estuary, Norwegian coast and the Baltic. Gametes were collected and stored as described by Blaxter (1955). Plaice eggs were obtained from sea-caught spawners off the Isle of Man and from plaice that had matured during an over-wintering period in outdoor ponds attached to the Marine Biological Station, Isle of Man. In some experiments the plaice eggs were stripped from the ripe parents, in other cases fertilized eggs were skimmed from the surface of the holding ponds. The cod eggs were obtained from a natural spawning of these fish kept in the aquarium of the Marine Biological Station, Isle of Man.

After fertilization in 500 ml jars the eggs were incubated in glass tanks of 5 to 50 liters capacity. Smaller numbers of eggs and larvae were kept in 500 ml jars and the water changed every second day. Glass fibre tanks, capacity 350 liters, were used for long term holding experiments. The water in these tanks was filtered and recirculated.

Low salinity water was made up by adding distilled water to sea water; high salinity water by adding NaCl to sea water. Freezing point depressions ( $\Delta^{\circ}\text{C}$ ) were determined using the apparatus of Ramsay & Brown (1955). Experiments were made at specific temperatures in the range 4–14°C. In some experiments the water was treated with antibiotics (sodium penicillin G and streptomycin sulphate mixture) to keep down bacterial growth (see Shelbourne, 1963).

## THE GAMETES

In both plaice and cod the mature gametes were isotonic with the blood of the parent, in the herring the semen was isotonic but the eggs were hypotonic (see Table 1).

Table 1  
FREEZING POINT DEPRESSIONS OF FISH BLOOD AND GAMETES ( $\Delta^{\circ}\text{C}$ )

Species	Adult Blood $\Delta$	Egg $\Delta$	Semen $\Delta$
Plaice.....	0.58	0.60	0.59
Cod.....	0.81	0.80	0.84
Herring.....	0.92	0.75	0.92

Measurements of changes in the osmotic pressure of the peri-vitelline fluid (see fig. 1) showed that the chorion of the egg in all three species was freely permeable, offering no protection against osmotic withdrawal of water in high salinities, but mechanically opposing the entry into the cytoplasm of the egg of more than a certain amount of water in low salinities (Lasker & Theilacker (1962) reported that removal of the chorion resulted in the rapid swelling and bursting of the eggs of *Sardinops caerulea* in low salinities). The sperm have no mechanical barrier to water movement and it is not yet known if any mechanism exists to oppose osmotic change.

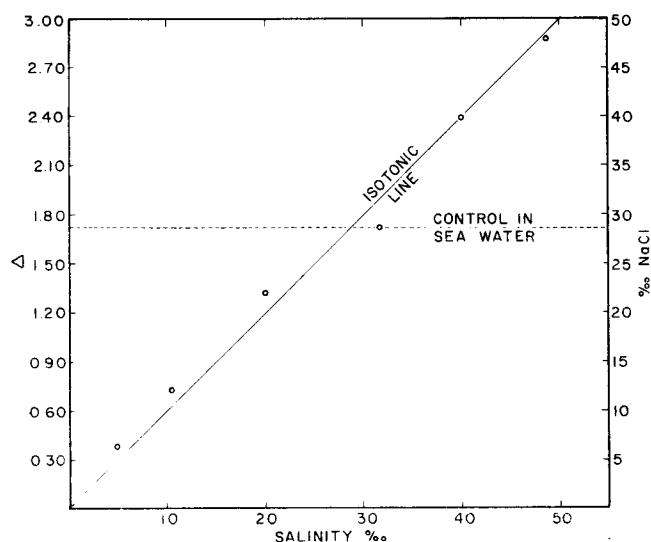

FIGURE 1. Osmotic pressure of the perivitelline fluid of herring eggs, 24 hours after transfer from sea water (32.3‰). Plaice and cod gave almost identical results.

**FERTILIZATION**

Measurements of percentage fertilization were made on both herring and plaice eggs as a criterion of tolerance of the gametes. Eggs and sperm were stripped directly into two separate 500 ml containers of the test salinity, allowed to stand for 1-2 minutes and then mixed; after a further 10 minutes the water was changed. The results are shown in fig. 2.

Blaxter and Holliday (1963) reported that immediately after the egg of the herring (which is demersal) was shed, the osmotic concentration of the yolk changed rapidly, approaching close to isotonicity with the water into which it was released. Preliminary results suggest that the same trend is not true in the pelagic eggs of the plaice and cod, in these the changes are not so extreme and a large concentration difference is still maintained between the yolk and the external salinity.

**EARLY DEVELOPMENT**

The size of the developing egg was fixed at or shortly after fertilization. The eggs were larger and heavier in the lower salinities due to their higher water content (see fig. 3).

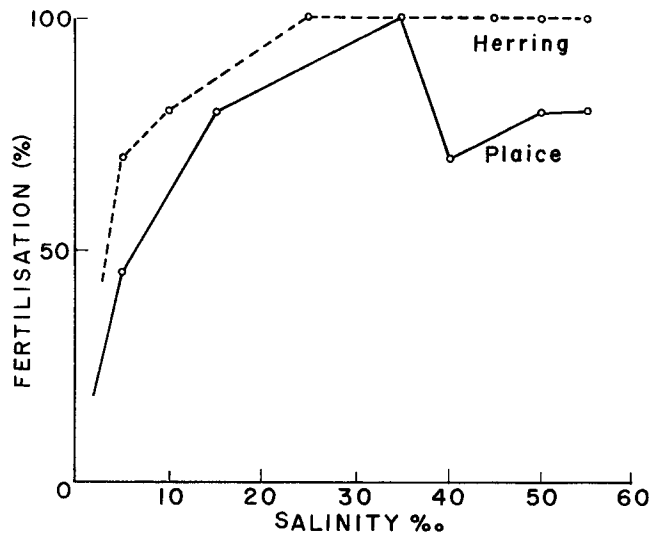

FIGURE 2. Percentage fertilization of herring and plaice eggs. (Data for herring from Holliday & Blaxter 1960).

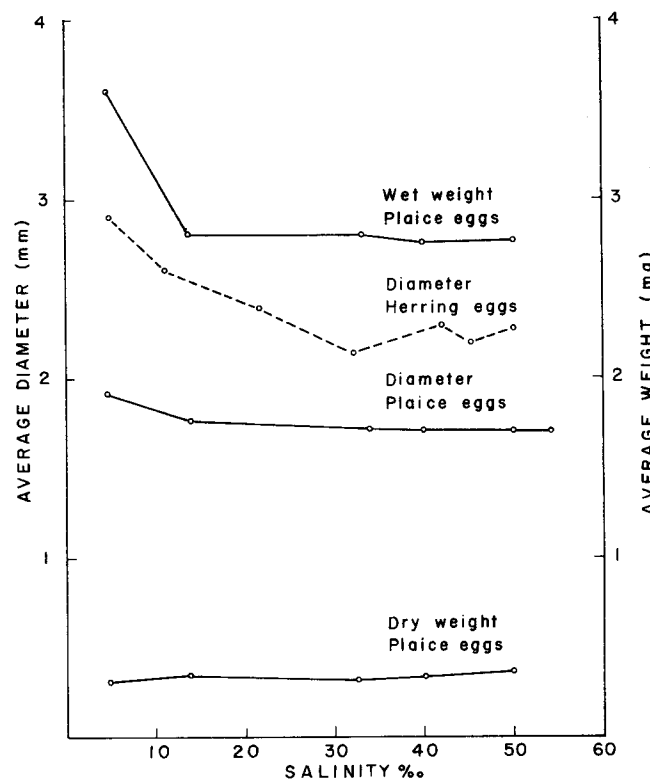

FIGURE 3. Size of developing herring and plaice eggs. (Data for herring from Holliday & Blaxter 1960).

The effects of the low salinities on the size of the developing egg were also apparent in the size of the individual cells of the blastula cap, and the diameter of the whole blastula cap (fig. 4a & b). If plaice and cod eggs, at the 8-16 cell stage, were transferred from sea-water (34‰) to other salinities, changes in the size of the cells and the appearance of the blastula cap occurred within 10 minutes. In the low salinities the cells became bloated, irregular in shape

and tightly pressed together. In the high salinities the cell boundaries became very sharply defined, the cells shrank slightly and became distinctly rounded, remaining in contact with each other only at points on their boundaries.

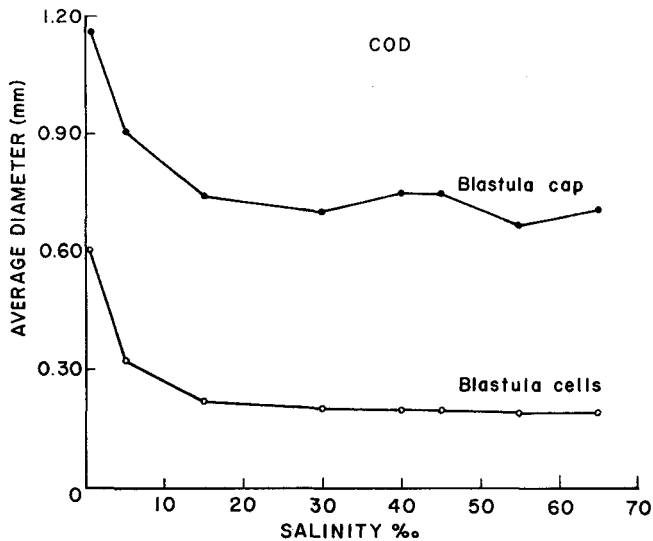

FIGURE 4. Size of the blastula cap and cells of cod and plaice eggs.

In the very low salinities (less than 5‰) the cells of the blastula cap of the plaice showed abnormal cleavage divisions; these divisions appeared to be the result of the tight packing together of the swollen cells. The divisions were sometimes incomplete and often unequal, producing a great range of cell sizes.

The blastula stage in the plaice had little tolerance to low salinities, but after gastrulation the tolerance to the lower salinities was greater (see fig. 5). In the cod heavy mortalities occurred prior to gastrulation in salinities outside the range 35–45‰. McMynn & Hoar (1953), working on the effects of low salinity on the survival of the eggs of *Clupea pallasii*, found that after the closure of the blasto-

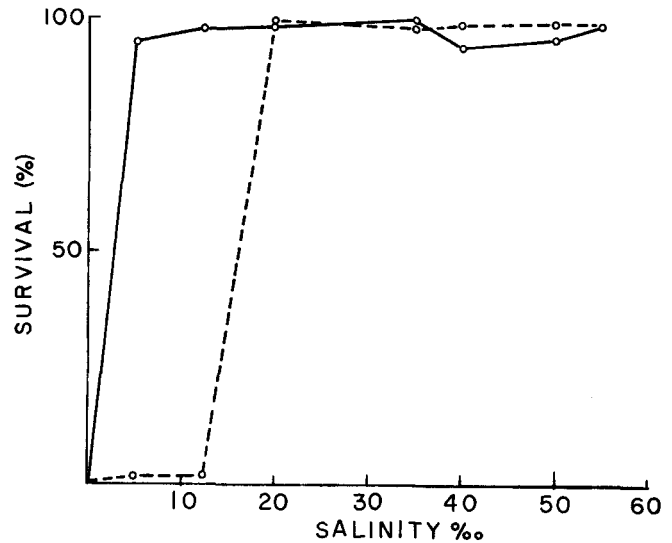

FIGURE 5. The effects of salinity on the survival of plaice eggs. --- blastula stage ——— gastrula stage

pore (i.e. the end of gastrulation) there was a greater ability to tolerate low salinities.

The ability of the developing egg to regulate the osmotic concentration of the yolk and tissues is still being investigated; preliminary results on the herring (Blaxter & Holliday, 1963) suggest that at the blastula stage there is little regulation of the yolk. After gastrulation, when the entire surface of the egg is covered by ecto and endodermal layers, there is developed the power to regulate, and the osmotic content of both the yolk and the tissues are, at the primitive streak stage, regulated to the level found at hatching. The cells of the ecto and endoderm appear to be the site of this regulation, and osmotic and ionic exchange between the egg and the medium takes place over the whole of the exposed ectodermal surface.

### HATCHING

The percentage of eggs hatching after incubation in a range of test salinities may be used as an index of the tolerance of the most susceptible stage in development. Figure 6 shows this data for the herring, plaice and cod. The developing eggs of the herring are more tolerant of the low salinities than either cod or plaice, and the plaice eggs are more tolerant of high salinities than the herring or cod.

Ford (1929) and McMynn & Hoar (1953) reported an increase in mortality of Atlantic and Pacific herring eggs at, or just prior to, hatching in low salinities. Larvae were found dead partly emerged from the chorions. This phenomenon was also found in the experiments on cod and plaice. It varied both from year to year and with the origin of the eggs. For example, eggs from pond-wintered plaice in 1963 showed heavier mortalities from this cause than eggs from pond wintered plaice in 1962 or sea wintered fish in 1962 or 1963. An inability to completely wriggle free of the chorion may be due to poorly developed tail musculature in the low salinities (as suggested by Battle (1930) in the rockling). However this was not espe-

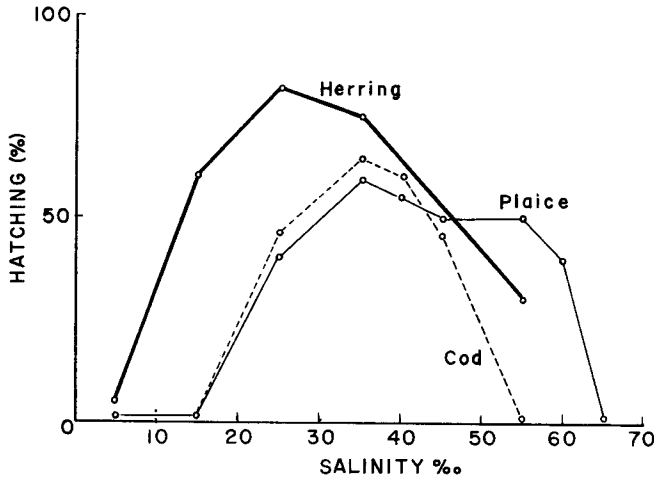

FIGURE 6. Percentage hatching of herring, cod and plaice eggs. (Data for herring from Holliday & Blaxter 1960).

cially obvious and it is possible that the low specific gravity of the water made it more difficult for the larvae to get free. It may also be that the chorions do not rupture so easily in low salinities, and differences in 'toughness' of the chorion might account for year to year variations.

There are several reports of structural abnormalities of larvae hatched in unnatural salinities (e.g. Battle, 1930 and Kryzhanovski, 1956). The abnormalities were usually either skeletal or distortions of the body cavities. About 2 per cent of the cod larvae hatched in 45‰ had deformed tails. No deformities were found in either plaice or herring larvae, although there was a clear difference in size between different

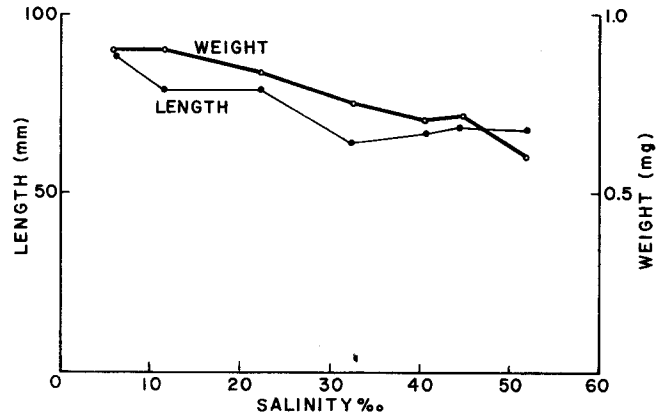

FIGURE 7. Size of newly hatched herring larvae.

salinities, this is shown for herring larvae in fig. 7. Plaice and cod showed very similar trends.

The size difference is almost certainly due to the greater water content of the larvae hatched in the lower salinities. The yolk sacs of larvae produced in salinities greater than 50‰ were shrunken, bright yellow in color and firm when touched. In salinities below 15‰ the yolk sacs were turgid and pale yellow in color.

THE LARVAE

The behavior of the newly hatched larvae depended on the salinity. Herring and plaice larvae in sea water (34‰) swam actively almost the whole time. Cod larvae tended to remain quiescent, floating near the surface and occasionally swimming in rapid bursts of

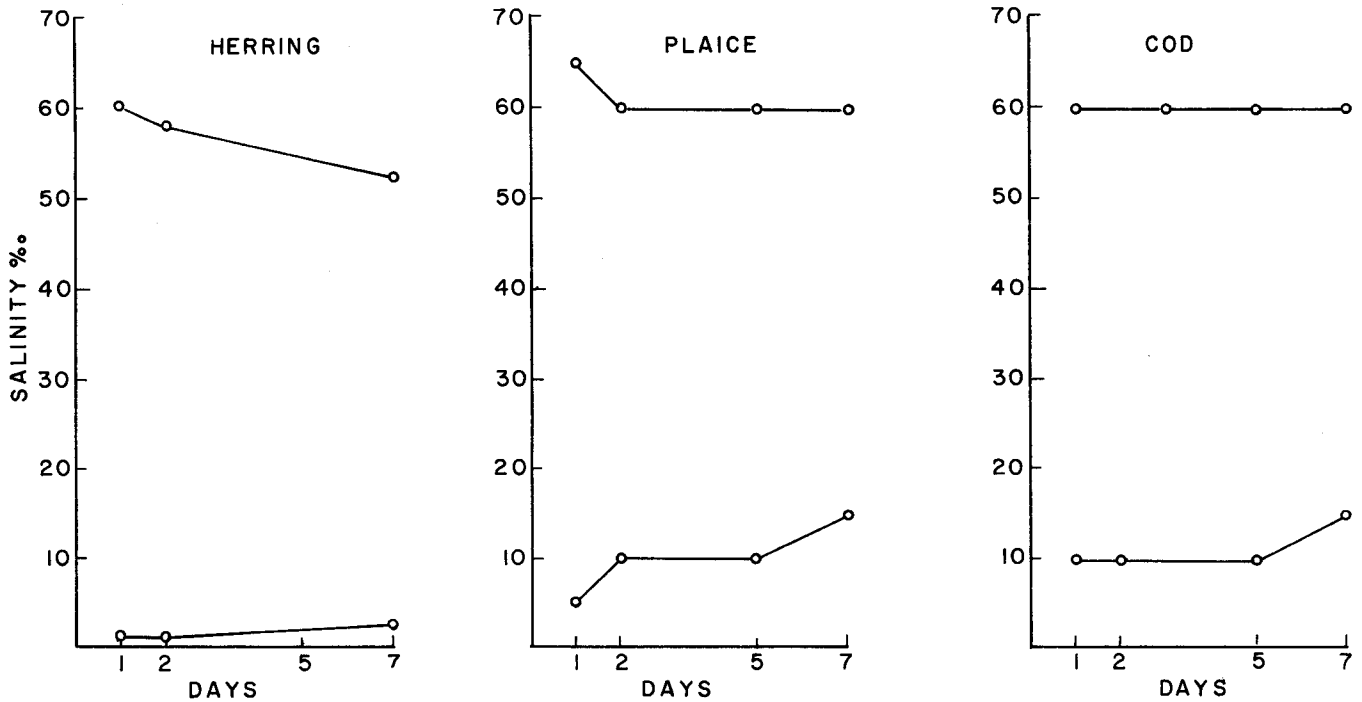

FIGURE 8. Salinity tolerance of newly hatched larvae. Criterion of tolerance was that 50% of the larvae should survive and remain active for 7 days in the test salinity.

activity. In salinities less than 12‰ all the larvae swam near to the bottom, and often lay there for long periods. In salinities from 12‰ to 45‰ activity was the same as in sea water. In salinities above 45‰ the herring and plaice larvae spent a good deal of time trying to swim down; cod larvae remained very quiescent on the surface, moving violently if disturbed. These differences in activity are discussed later in relation to energy expenditure and survival in different salinities.

The results of salinity tolerance experiments on the yolk sac larvae are shown in figs. 8a, b & c. Clearly at this stage all three species are capable of withstanding a wide range of salinities, for the test periods of up to 7 days. Again an interesting difference between the species was the greater tolerance of yolk sac herring larvae to the lower salinities, and the greater tolerance of plaice and cod larvae to higher salinities. It has been shown (Holliday & Blaxter, 1960) that the survival in high and low salinities in the herring is based on tissue tolerance and body fluid regulation. This is also true in plaice and preliminary results on the cod do not suggest any different mechanism involved. Figures 9 and 10 show changes in total body weight and in the freezing point of the tissue fluids which indicate the osmotic movement of water into the tissues in low salinities and from the tissues in high salinities. There is a short term tolerance by the tissues of internal osmotic concentrations equivalent to

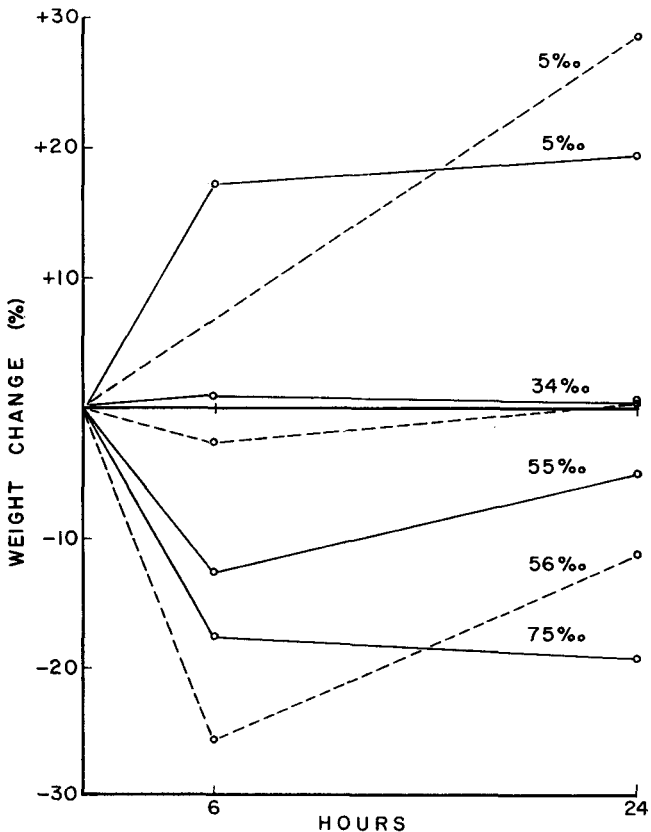

FIGURE 9. Weight changes of larvae after transfer from sea water (34‰) to the test salinity. ----- herring (data from Holliday & Blaxter 1960). ——— plaice.

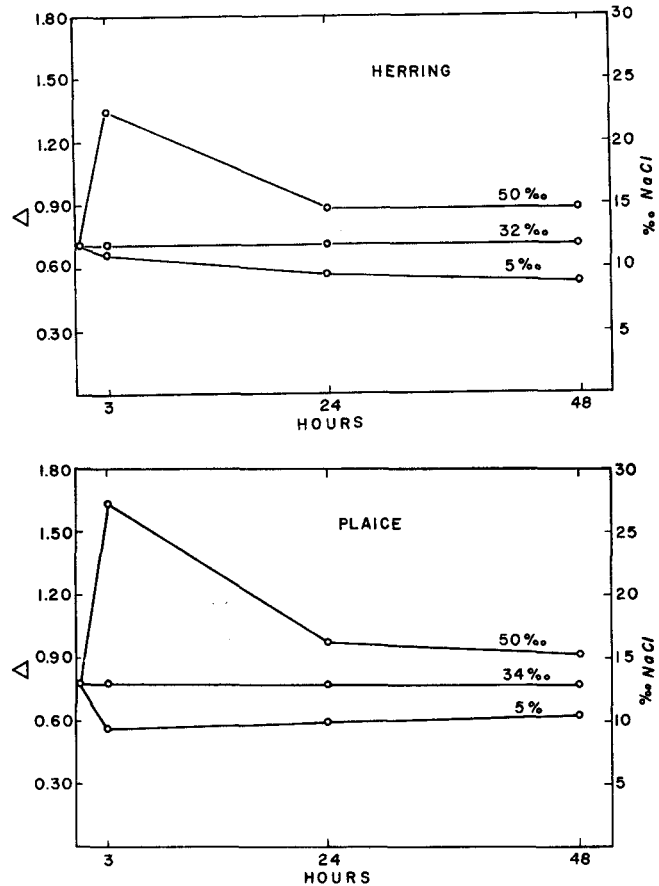

FIGURE 10. Osmotic concentrations of larval body fluids. Plaice larvae transferred from 34‰ . . . Herring larvae transferred from 32‰.

salinities of 30‰ in the plaice and 22.5‰ in the herring. Regulation takes place within 24 hours, returning the body fluid concentration to a level equivalent to about a third of the external environment in salinities of 35‰ and above, and at a level equivalent to about 10‰ in salinities below sea water.

The observations of changes in size of the blastula cells are a strong indication that changes in body water brought about by osmosis take place at the intra-cellular level. So far there is no evidence for this hypothesis in the larval stages, but Gordon (1959) concludes, for adult *Salmo trutta*, that tissue concentration changes were attributable to changes in intra-cellular water.

### THE EFFECTS OF AGE ON SALINITY TOLERANCE

Kurata (1959) showed that salinity tolerance in *Clupea pallasii* varied with age, 10-day old larvae were more tolerant, than yolk sac larvae, while 20-day old larvae were less tolerant. Holliday & Blaxter (1960) found that post-metamorphic *Clupea harengus* had a much narrower tolerance than the yolk sac larvae (Fig. 11a and b). Difficulties in rearing herring larvae to the stage of metamorphosis prevented the determination of the time when this change in tolerance oc-

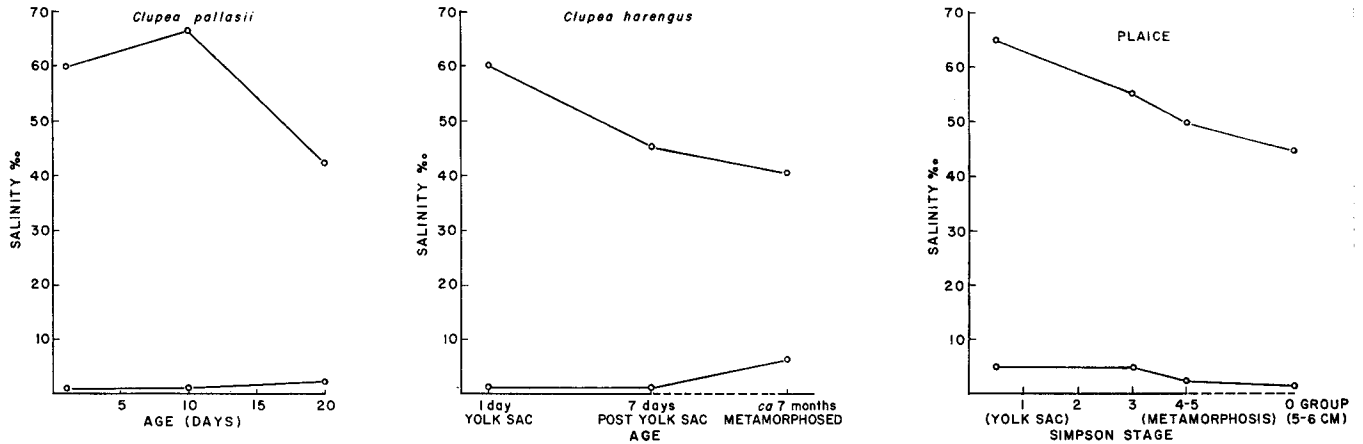

FIGURE 11. The effects of age on salinity tolerance. (Data for *Clupea pallasii* from Kurata 1959).

curred. This difficulty did not arise in the case of the plaice. Figure 11 c shows the salinity tolerance of plaice larvae at different stages in development.

Clearly the change in tolerance is a gradual process completed just after metamorphosis, when the typical adult pattern is established. In the plaice the tolerance to high salinities decreased, but it increased to low salinities. In the herring after metamorphosis, tolerance decreases to both high and low salinities.

At metamorphosis the epidermis thickens, develops scales and becomes chiefly protective in function. This is incompatible with the previous respiratory and regulatory functions and these processes are restricted to the gill epithelium.

Nothing is known of the osmo-regulatory functions of the pro-nephric kidney found in the early larvae of the herring, plaice and cod. The part played by the gut in osmo-regulation in the larvae is also unknown. It is normally not fully formed until a short time after hatching. It seems likely, at least from the structural point of view, that it is at metamorphosis that the adult pattern of regulation, based on the balance between gut absorption and renal and extra-renal excretion, is established.

**SALINITY AND METABOLISM**

The metabolic cost of osmotic regulation has been assessed as insignificant for the larvae of *Sardinops caerulea* (Lasker & Theilacker, 1962), and considerable for young and adult *Plotosus anguillaris* Job, (1959). It is not possible to generalize, as such factors as the state of adaptation, the sensitivity of the tissues of different species and the age and 'fitness' of the individual fish will almost certainly affect the metabolic response to different salinities.

Recent work by Holliday, Blaxter and Lasker (1964) on oxygen uptake of herring larvae showed that if the larvae were reared in a wide range of salinities (5-55‰) oxygen uptake did not vary with the salinity. However if the larvae were subjected to an abrupt change in salinity then oxygen uptake oscillated during the period of osmotic change, returning to its original level after regulation had taken place. It was found necessary to obtain a standard degree

of activity by anaesthetizing the larvae. As described earlier the difference in buoyancy of the larvae in different salinities resulted in activity (and hence oxygen uptake) being less in the low salinities. For this reason low salinities probably make less demands on the metabolism of the larvae. The ability to survive in a given salinity may also depend on the available food supply, a factor which may vary considerably in the sea. Shelbourne (1957) reported starving plaice larvae associated with poor plankton patches in the North Sea. He suggested that death might be due to a breakdown of osmo-regulatory ability. The results of experiments on the survival of starving larvae in different salinities are shown in Figure 12.

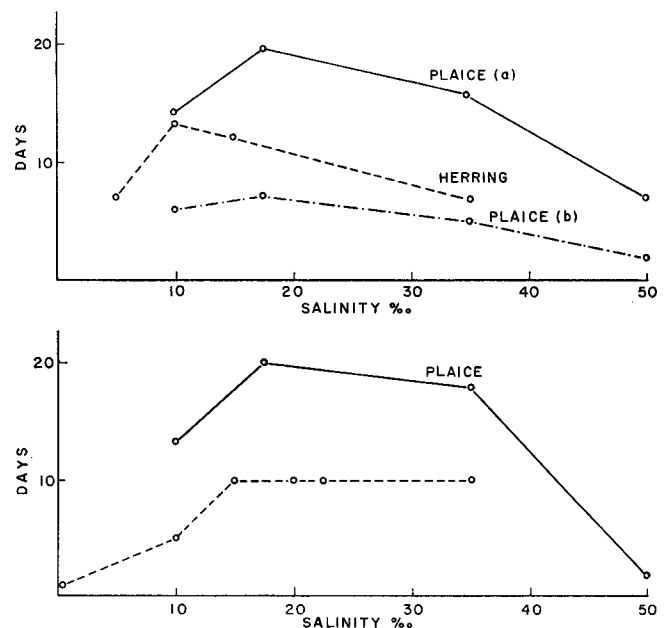

FIGURE 12. The survival of starving herring and plaice. a. Yolk sac larvae. Herring and plaice (a) starved in the test salinities. Plaice (b) starved for 10 days in sea water (34‰) then transferred to test salinity. b. ———, Plaice larvae, Simpson stages III and IV. - - - - O Group plaice 38-50 mm. (Data for herring and O group plaice from Bishai 1961 at temperatures of 13-17° C; other experiments at 8° C).

Survival is best in salinities from 10‰ to 17.5‰. These salinities are not far from isotonic with the body fluids and it might be argued that conservation of osmotic energy and therefore longer survival was possible for this reason. It seems more likely however that the beneficial effects of these salinities again lies in the effects of their specific gravity on the activity of the larvae. The favorable effects of salinities approximately isotonic with the body fluids were also reported by Gilson & Hirst (1955) on *Lebistes*. Growth rate was fastest in 9‰ sea water. Shanklin (1954) demonstrated in *Fundulus* the dependence of osmotic regulation on specific metabolic pathways. In the presence of suitable inhibitors the embryo would only tolerate isotonic salinities, when normally they would survive in 70‰.

## GENERAL CONCLUSIONS

It would appear that the ability to tolerate a wide range of salinities is a characteristic of the tissues of marine fish larvae, and it may be an indication of the unspecialized nature of the embryonic cells. Some stages are more tolerant than others, and the question of the long term effects of salinity changes is still to be investigated. Although survival for a given time period has been the criterion of tolerance adopted in this work, the absolute criterion of tolerance perhaps ought to be that the organism should survive and produce normal offspring. Preliminary experiments indicate that young herring and plaice can survive many months in water of 6–10‰ and grow apparently normally.

It is unlikely that extremes of salinity will be met with by eggs of most marine teleosts, although in areas such as the Baltic low salinities are usual; Brandhorst (1959) observed spawning herring in the Kiel canal in a salinity of 5‰ and some Baltic herring spawn in fresh water. Zaitsev (1955) reported that salinities as high as 60.25‰ occurred naturally in bays of the Black Sea. However the eggs of the Black Sea flounder did not hatch at all in salinities greater than 50.15‰, and percentage hatching was low in salinities above 39.75‰.

It would appear unlikely that minor salinity changes in rearing tanks would be harmful to larvae, although until long term experiments are done this cannot be certain. The larvae appear to be well adapted to meet any naturally occurring osmotic conditions.

## SUMMARY

Some effects of salinity on the developing eggs and larvae of *Clupea harengus*, *Pleuronectes platessa* and *Gadus callarias* are described. Measurements were made of percentage fertilization, size of developing eggs, percentage hatching and the salinity tolerance of various stages in development. Measurements of the freezing points of the tissue fluids indicated the osmotic movements of water into and from the organism. The effects of age, starvation, oxygen uptake and activity in relation to salinity were also investigated. The results are discussed with reference to survival at sea and in rearing tanks.

## REFERENCES

- Battle, H. I., 1930. Effects of extreme temperatures and salinities on the development of *Enchelyopus cimbrius* L. *Contr. Canad. biol. N.S.*, 5 (6), 107–192.
- Bibov, N. E., 1960. Acclimatization of salaka (Baltic herring) *Clupea harengus membras* L. in the Aral sea. *I.C.E.S. Herring Committee*, Paper No. 135 (mimeo).
- Bishai, H. M., 1961. The effect of salinity on the survival and distribution of larvae and young fish. *J. Cons. int. Explor. Mer.* 26, 292–311.
- Blaxter, J. H. S., 1955. Herring Rearing—I. The storage of herring gametes. *Mar. Res. Scot.* 3, 12 pp.
- Blaxter, J. H. S. and Holliday, F. G. T., 1963. The behaviour and physiology of the herring and other clupeids. In "Advances in Marine Biology" Vol. 1, Ed. F. S. Russell, 410 pp. Academic Press, London and New York.
- Brandhorst, W., 1959. Spawning activity of the herrings and growth of their larvae. *Int. oceanogr. Congress, New York*, Preprints, 218–21.
- Ford, E., 1929. Herring investigations at Plymouth VII. On the artificial fertilization and hatching of herring eggs under known conditions of salinity with some observation on the specific gravity of the larvae. *J. mar. biol. Ass. U.K.* 16, 43–8.
- Gilson, M. B. and Hirst, B., 1955. The effect of salinity and temperature on the pre-adult growth of guppies. *Copeia*, 3, 241–3.
- Gordon, M. S., 1959. Ionic regulation in the Brown Trout (*Salmo trutta* L.). *J. exp. Biol.* 36, 227–52.
- Holliday, F. G. T. and Blaxter, J. H. S., 1960. The effects of salinity on the developing eggs and larvae of the herring (*Clupea harengus* L.). *J. mar. biol. Ass. U.K.* 39, 591–603.
- Holliday, F. G. T., Blaxter, J. H. S. and Lasker, R., 1964. Oxygen uptake of developing eggs and larvae of the herring (*Clupea harengus*). *J. mar. biol. Ass. U.K.* 44, 711–723.
- Job, S. V., 1959. The metabolism of *Plotosus anguillaris* (Bloch) in various concentrations of salt and oxygen in the medium. *Proc. Ind. Acad. Sci.* 50 (B), 260–267.
- Johansen, A. C., 1908. Contributions to the biology of the plaice IV. Is the plaice indigenous to the true Baltic? *Medd. Komm. Havundersog. Kbl., Ser. Fisk.* 3 (5), 46 pp.
- Kryzhanovskii, S. G., 1956. Development of *Clupea harengus membras* in water of high salinity. (In Russian), *Voprosy Ikhtologii* 6, 100–4.
- Kurata, H., 1959. Preliminary report on the rearing of the herring larvae. *Bull. Hokkaido Reg. Fish. Res. Lab.* 20, 117–38.
- Lasker, R. and Theilacker, G. H., 1962. Oxygen consumption and osmoregulation by single Pacific sardine eggs and larvae. (*Sardinops caerulea* Girard). *J. Cons. int. Explor. Mer.* 27, 25–33.
- McMynn, R. G. and Hoar, W. S., 1953. Effects of salinity on the development of the Pacific herring. *Canad. J. Zool.* 31, 417–32.
- Ramsay, J. A. and Brown, R. H. J., 1955. Simplified apparatus and procedure for freezing point determinations upon small volumes of fluid. *J. sci. Instrum.*, 32, 273–5.
- Shanklin, D. R., 1954. Evidence for active transport in *Fundulus* embryos. *Biol. Bull., Woods Hole*, 107, 320.
- Shelbourne, J. E., 1957. The feeding and conditions of plaice larvae in good and bad plankton patches. *J. mar. biol. Ass. U.K.* 36, 539–52.
- Shelbourne, J. E., 1963. A marine fish-rearing experiment using antibiotics. *Nature Lond.* 198, 74–5.
- Shelbourne, J. E., Riley, J. D. and Thacker, G. T., 1963. Marine fish culture in Britain. I. Plaice rearing in closed circulation at Lowestoft, 1957–60. *J. Cons. int. Explor. Mer.* 28, 50–69.
- Zaitsev, J. P., 1955. Influence of the salinity of the water on the development of the eggs of the flounder (*Pleuronectes fesus luscus* Pallas). *Dokl. Akad. Nauk. S.S.S.R.*, 105 (b), 1364.

# THE PHYSIOLOGY OF PACIFIC SARDINE EMBRYOS AND LARVAE

REUBEN LASKER

U.S. Bureau of Commercial Fisheries Biological Laboratory  
La Jolla, California

## INTRODUCTION

The purpose of this paper is to review the present state of knowledge on the physiology of sardine eggs and larvae, to show the relationship between the developing larva and its yolk supply, and finally to offer some deductions on what the available food supply for larvae must be after the yolk supply is exhausted.

## GENERAL BIOLOGY OF THE SARDINE EGG AND LARVA

The sardine egg after fertilization is planktonic, has a chorion about 1.7 mm in diameter, a perivitelline space containing sea water and a spherical yolk sac about 1 mm in diameter. The chorion is freely permeable to water, salts and respiratory gases (Lasker and Theilacker, 1962). The yolk mass and developing embryo is less dense than the chorion and floats within the subchorionic space abutting the inside of the chorion at the top. During stage XI (see Ahlstrom, 1943 for stage descriptions) with development of the embryonic tissue and the concomitant utilization of the light yolk the entire egg sinks. This sinking period (depending on the temperature and density of the water) can be as long as 2-3 hours and at a rate of about two meters per hour whereupon the animal hatches out, probably by utilizing a hatching enzyme. Unencumbered by the heavier chorion the larva floats upward. At this stage the sardine larva lacks a mouth, an open gut, gills, pigment in the eyes, and its organ systems are virtually undeveloped. An electron micrograph (Threadgold and Lasker, unpublished) of the skin of the newly hatched larva is shown in Figure 1. The entire skin is composed of two cell layers, is  $1.7\mu$  thick in the fin-fold region, and  $3\mu$  in the main body region. In cross section each cell of the outer layer has an internal densely staining rod-shaped structure which may be the precursor of the true scale. There are structures in the outer cell layer which suggest a secretory function for the epithelium but an analysis of the role of subcellular structures in osmoregulation is yet to be done. As the larva develops (at  $15^{\circ}\text{C}$  for example) the mouth begins to form at 162 hours post-spawning and the gut opens four hours later. At this point the bulk of the yolk has been consumed and only a trace remains. Fully pigmented eyes and a movable jaw are complete at approximately 170 hours and the last trace of yolk is utilized seven hours later. At first opening the gut is  $40\mu$  in

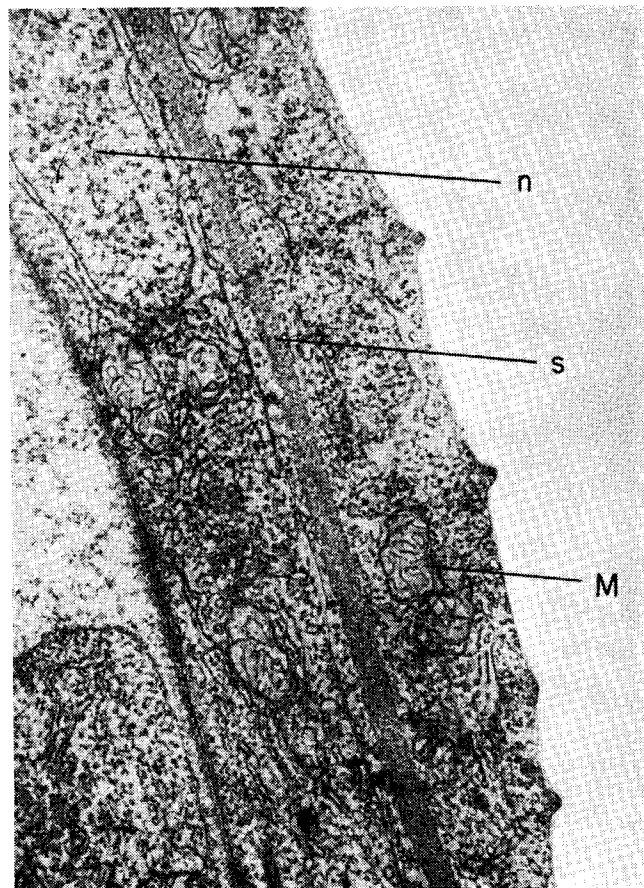

FIGURE 1. Electron micrograph photograph of a cross section of larval Pacific sardine skin. M, mitochondria; n, nucleus; s, scale anlage (?) photo by Dr. L. T. Threadgold, Queen's University, Belfast, Ireland). Larval skin is approximately  $3\mu$  across.

diameter and can be distended to  $100\mu$  the following day with food. In dense suspensions of unicellular algae (e.g. *Platymonas subcordiformis*) larvae with their intestines fully opened rapidly fill their gut by swallowing.

## ENERGY REQUIREMENTS

During development, as organized tissue is added, there is a gradual but definite increase in oxygen uptake (Fig. 2) and at the time the yolk is completely consumed the animal has its highest basal rate. Swimming movements are frequent and cause an increase in respiration. A balance sheet has been



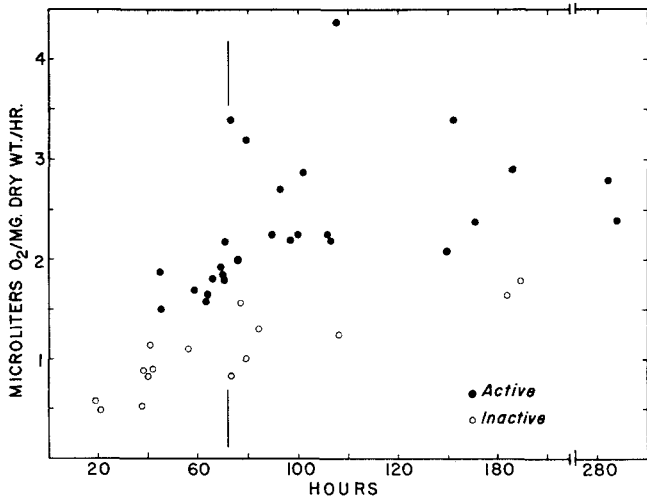

FIGURE 2.  $Q_{10}$ 's of active and inactive Pacific sardine eggs and larvae ( $14^{\circ}\text{C}$ ). The vertical line at 72 hours indicates time at hatching. Each dot represents an individual egg or larva. (Lasker and Theilacker, 1962).

constructed (Table 1) which shows that at  $14^{\circ}\text{C}$  the sardine larva metabolizes at a steady high rate and reaches a point where there is not enough yolk remaining to provide all the energy needed. This time is approximately 10 hours prior to complete eye pigmentation and development of the functional jaw. Conversion efficiency of the yolk to somatic tissue over the entire yolk sac period is high (78 per cent at  $14^{\circ}\text{C}$ ), and may be greater at slightly higher temperatures ( $16^{\circ}\text{C}$ ) if the attainment of maximum length is taken as the criterion (Fig. 3). Calculations of efficiency with time over the developmental period show that conversion efficiency declines as the embryo grows older (Table 2) and a greater proportion of the energy available is used up in catabolic processes.

Since the yolk supply is presumably ideally suited to the metabolic and growth needs of the embryo and larva, it should be possible to deduce from information of the energy value of yolk and the meta-

TABLE 1  
AVERAGE YOLK UTILIZATION BY SARDINE EMBRYOS AND LARVAE AT  $14^{\circ}\text{C}$  EXPRESSED AS DIMINISHING VOLUME AND CALORIC UPTAKE  
(Lasker, 1962)

Elapsed hours from spawning	Yolk volume ( $\text{mm}^3$ )	Calories remaining	Catabolic calories
0	0.56	0.300	0
42	0.48	0.260	0.0063
71	0.29	0.160	0.0096
80	0.25	0.130	0.0040
100	0.16	0.085	0.0088
120	0.09	0.048	0.0088
140	0.04	0.021	0.0088
160	0.01	0.005	0.0088
180	0	0	0.0088
		Total	0.064

$$\text{Per cent efficiency} = 100 \times \frac{0.300 - 0.064}{0.30} = 78.7\%$$

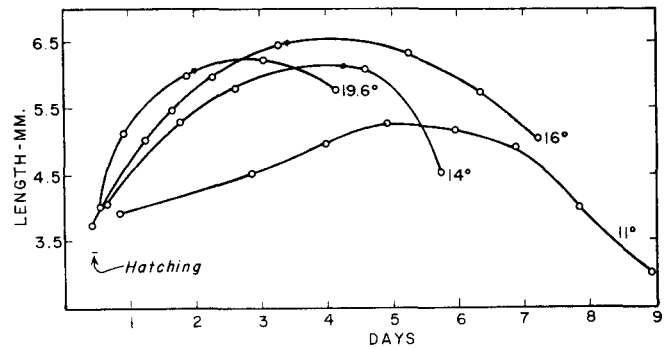

FIGURE 3. Increase in length of sardine larvae at four different temperatures. (Lasker, 1964).

bolic requirements of sardine larvae at yolk sac absorption, the food requirements of the larva when it begins to feed. Knowledge of the  $Q_{10}$  of yolk absorption (i.e., the relative rates over a span of  $10^{\circ}\text{C}$ ) permits these calculations to be made for a range of environmental temperatures.

The caloric value of a sardine egg yolk of  $0.56 \text{ mm}^3$  averages 0.3 calorie and at  $14^{\circ}\text{C}$  this is consumed in 180 hours (Lasker, 1962). Table 1 also shows the calorie requirement for catabolism by a sardine larva with time. The remainder of the yolk is utilized for growth. During the last day of yolk absorption the animal continues its high rate of metabolism but there is less yolk energy available than the catabolic demand. To maintain the same catabolic rate with no growth, the larva must eat and digest the caloric equivalent of  $4.4 \times 10^{-4} \text{ cal/hr}$ . If the same caloric uptake is needed that was supplied by the yolk, the larva must ingest the equivalent of  $17 \times 10^{-4} \text{ cal/hr}$ .

Food organisms taken by 4-6 mm sardine larvae range in cross sectional diameter from  $25\text{-}125\mu$  and are chiefly copepod nauplii (Arthur, 1956). The mode falls between  $75$  and  $80\mu$ . The volume of a nauplius  $80\mu$  wide is approximately  $4.0 \times 10^{-4} \text{ mm}^3$  and the dry weight of an animal of this size is  $1.2 \times 10^{-7} \text{ g}$  if the animal is 70 percent water. The caloric content of the copepods *Calanus helgolandicus* and *Tigriopus cal-*

TABLE 2  
CHANGING INCORPORATION EFFICIENCY WITH YOLK UTILIZATION IN SARDINE EMBRYOS ( $14^{\circ}\text{C}$ )

1	2	3	4	5	6
Elapsed hours from spawning	Time intervals	Total calories consumed per time interval	Catabolic calories per time interval	Incorporated calories 3-4	Incorporation efficiency
42	42	.040	.0063	.0337	84
71	29	.100	.0096	.0904	90
80	9	.030	.0040	.0260	87
100	20	.045	.0088	.0362	80
120	20	.037	.0088	.0282	76
140	20	.027	.0088	.0182	67
160	20	.016	.0088	.0072	45

$$\text{Per cent incorporation efficiency} = 100 \times \frac{\text{Incorporated calories}}{\text{Total calories consumed}}$$

*ifornicus* is shown in Table 3 (mean caloric value = 5100 cal/g dry weight).

TABLE 3  
CALORIC CONTENT OF TWO SPECIES OF COPEPOD, *TIGRIOPUS CALIFORNICUS* AND *CALANUS HELGOLANDICUS*

(Measurements made by Drs. B. L. Slobodkin and S. Richman, University of Michigan)

<i>T. californicus</i> , 0.9-1.1 mm	
Dry wt. (mg) .....	cal/g dry wt.
13.66 .....	5250
14.63 .....	5268
15.00 .....	5374
<i>C. helgolandicus</i> , stage V and adults + 6.5% other planktonic material	
25.26 .....	5125
20.10 .....	5103
24.95 .....	4917
24.05 .....	4910

Average of 7 determinations: 5135 cal/g dry wt.

Therefore at 14°C, to maintain catabolism, 0.7 copepod nauplius/hr must be ingested and digested by the newly feeding larva. To continue energy uptake equivalent to average yolk absorption, 2.8 copepod nauplii/hr are required. Per cent digestion is very high in fishes, usually over 80 per cent (Winberg, 1961). With a correction for per cent digestion these values can be adjusted to 0.9 nauplius/hr for catabolism only and 3.5 for total metabolism (which includes growth).

The effect of temperature on yolk absorption was determined and is plotted in Figure 4; a regression line is fitted to the data. The  $Q_{10}$  for this process is 4 for the environmental temperature interval from 15 to 21°C. Therefore, for each 5°C rise in temperature the rate of yolk utilization is doubled and will be reflected in the food requirement by doubling the number of food organisms required when the larva starts feeding.

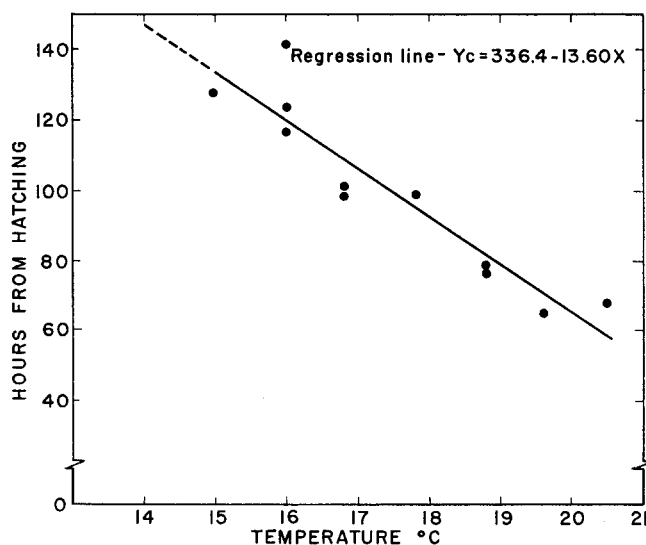

FIGURE 4. The effect of temperature on yolk absorption ( $Q_{10}=4$ ).

## VARIATIONS IN THE YOLK SUPPLY

Basing metabolic measurements on an average larva avoids the obvious fact that all eggs are not alike and all do not have the same potential. For example, there are small but significant differences in the amount of yolk available to the newly fertilized sardine egg, and in the chemistry and caloric value of the yolk. Yolk volumes may vary from 0.5 mm<sup>3</sup> to 0.6 mm<sup>3</sup> and the per cent dry weight of the yolk may span in one standard deviation 7.4 to 10.2 per cent. Although the nitrogen content (and therefore the protein) of the yolk is very constant, variations in the fat can be great. Phospholipids varied from 10.3-17.5 per cent in six individual determinations, total fat from 11.0-14.4 per cent in 11 determinations and caloric value for yolk from 5007 to 5598 cal/g in 9 determinations. An egg having a yolk volume of 0.5 mm<sup>3</sup>, could provide as little as 0.185 cal to the growing embryo which may be compared with the 0.3 cal available in an egg of average volume, dry weight and caloric value.

Figure 6 illustrates the variation in growth of sardine larvae kept at 17°C in the laboratory. All larvae hatch out at approximately the same length, but as time progresses and yolk reserves are depleted, the divergence in length becomes great. The consequences of variations in the yolk supply of individual embryos is not known as yet, but it seems safe to conclude that this may contribute to the generally observed wide differences in growth of sardine larvae at all temperatures.

Growth curves of yolk sac larvae at different temperatures (Fig. 3) show that after reaching a maximum length the sardine larva begins to shrink. Shrinking is a result of starvation since weight loss is a concomitant feature of this phenomenon and it can be shown that there is a sharp decrease in the quantity of structural proteins associated with this shrinking. The change in amount of cold trichloroacetic acid precipitable proteins with time and development is plotted in Figure 7. The curve shows the build-up of the somatic proteins and the subsequent decrease in these proteins with starvation; a horizontal bar indicates the time span over which the articulated jaw may complete its development. It is prior to this period that a metabolic deficit begins, and this once again illustrates the delicate balance between metabolic needs and the onset of feeding.

As far as growth of the post yolk sac larva is concerned no information is as yet available and until we are able to rear them in the laboratory, energy and food requirements will not be precisely known.

## SWIMMING

The most important drain on the energy resource of the sardine larva is its swimming activity. Lasker and Theilacker (1962) have shown that swimming can increase the oxygen consumption of a sardine larva as much as 3.5 times its basal uptake but the average increase in  $Q_{O_2}$  ( $\mu\text{l O}_2/\text{larva}/\text{hr}$ ) is 2 × the basal rate (Table 4). Dr. Schumann discusses in this symposium

**TABLE 4**  
**AVERAGE INCREASE IN OXYGEN CONSUMPTION BETWEEN**  
**INACTIVE AND ACTIVE EGGS AND LARVAE (14° C)**  
 $Q_{O_2} = \mu\text{l O}_2/\text{egg or larvae}/\text{hour}$  (Lasker and Theilacker, 1962)

	Number	$Q_{O_2}$ inactive	Number	$Q_{O_2}$ active	Increase $O_2$ consumption with activity
Eggs-----	8	0.0321	10	0.0714	2.2×
Larvae-----	7	0.0533	17	0.1072	2.0×

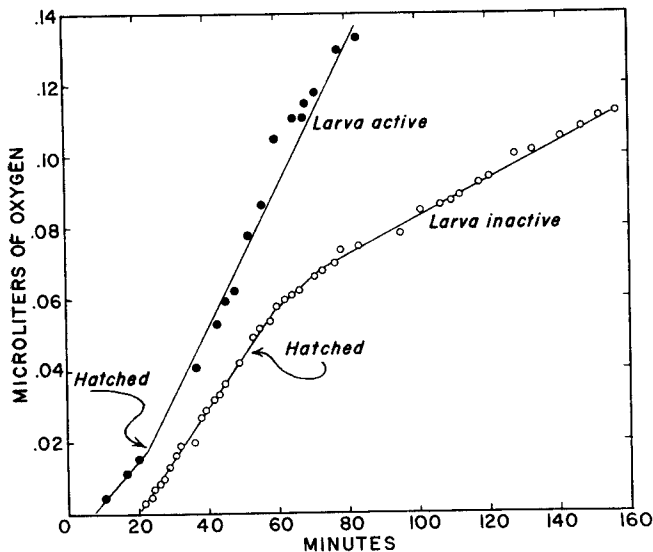

FIGURE 5. Effect of activity on oxygen consumption of sardine larvae. (Lasker and Theilacker, 1962).

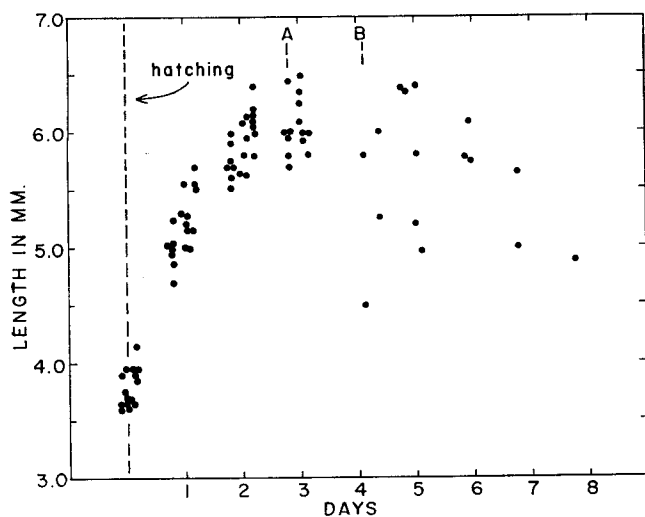

FIGURE 6. Variation in length of developing sardine larvae at 17° C. "A" indicates the time when development of a moveable jaw and eye pigmentation is completed; "B" is the time when the yolk is completely consumed.

the behavior of sardine larvae after yolk absorption and during the onset of their feeding. He has found that swimming and feeding alternate with periods of

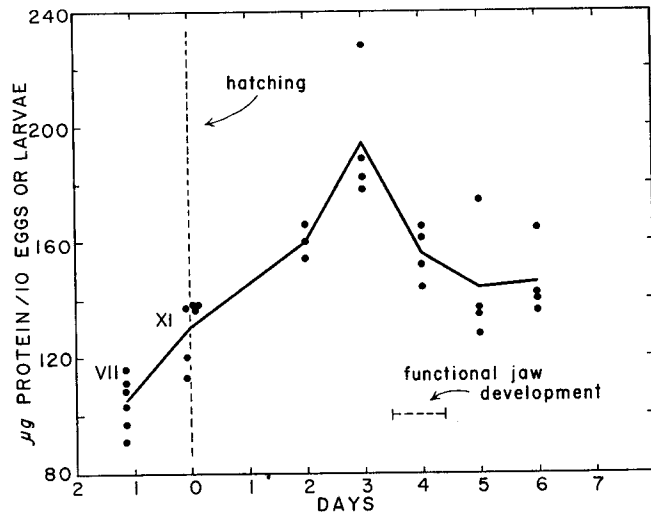

FIGURE 7. The quantitative change of somatic protein with time of development (16° C). Protein was precipitated with cold trichloroacetic acid.

rest, so that on the average a larva spends about 40% of its time swimming and 60% resting. As the larva grows, swimming time gradually increases and is continuous when the animal reaches about 9 mm in length. Figure 5 illustrates the effect of swimming activity on the energy requirement of the larva. The fact that the newly-feeding animal has alternate periods of rest and swimming allows the larva to conserve its energy at a critical time in its life cycle. Were swimming to be continuous at this time and no food found, the two-fold increase in its food requirement would further aggravate the energy deficit it is already experiencing.

### OSMOREGULATION

The sardine larva is hypotonic to sea water and thus must osmoregulate. Figure 8 presents the osmolar concentrations of sardine embryos and larvae compared with adult sera and plasma (sea water  $M = 0.56$ ). The surface membranes are permeable to the

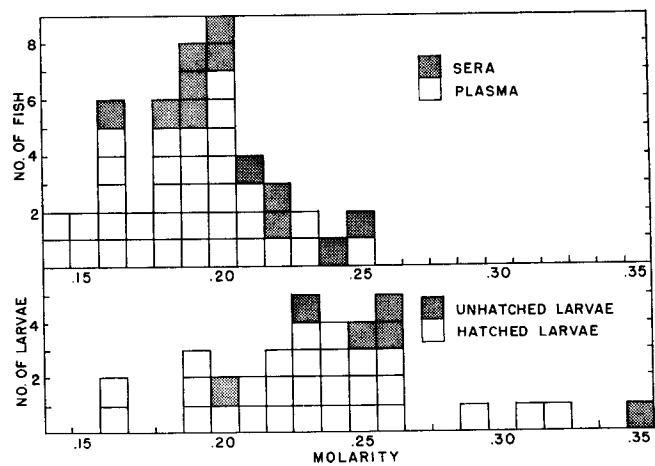

FIGURE 8. Osmolarities of sardine larval yolk and adult sardine sera and plasma.

environment since a loss of salts can be demonstrated after placing the animal in fresh water. Electron micrographs show a typical naked epithelium exposed to sea water. To maintain the hypotonic internal concentration a steady flow of salts must be excreted and water conserved (presumably by the epithelium). No significantly different oxygen uptake was found in larvae at different salinities and our conclusion was that the energy requirement for this physiological function was negligible (Lasker and Theilacker, 1962).

## TEMPERATURE

Incubation time, development of a functional jaw and fully pigmented eyes and yolk utilization (Fig. 4) all have a  $Q_{10}$  of 4 over the temperature range of 14 to 21°C (Lasker, 1964). At temperatures below 13°C sardine eggs hatch and the larvae develop to some extent, but there is no formation of a jaw and the eyes fail to pigment, therefore 13°C must be considered the lower limit for survival of sardine larvae.

The relative rates of development given in Table 5 indicate that at the lower temperature range, 15°–13°C, sardine larvae spend respectively 2 and 3 times as long in the larval stage as they do at 21°C, but differences in developmental rate at higher environmental temperatures are slight because the time-temperature curve approaches an asymptote. For example development is only 1.2 times longer at 19°C than at 21°C.

TABLE 5  
COMPARATIVE RATES OF EGG INCUBATION AND LARVAL JAW DEVELOPMENT—EYE PIGMENTATION AT DIFFERENT TEMPERATURES. RATE AT 21° = 1

(Lasker, 1964)

Incubation Time		Eye Pigmentation and Jaw Development
Temp.		
11	4.12	----
12	3.38	----
13	2.74	2.77
14	2.31	2.33
15	2.00	2.02
16	1.77	1.76
17	1.58	1.54
18	1.42	1.37
19	1.27	1.22
20	1.16	1.11
21	1.00	1.00

The Northern Anchovy (*Engraulis mordax*) was also studied with respect to temperature and presents an interesting comparison to the sardine. The anchovy's larval development is normal at 11 and 12°C and at these lower temperatures the anchovy hatches about a day earlier than the sardine. However, at higher temperatures the difference in rates between the two species diminishes although the anchovy always hatches and develops earlier. This is illustrated in Figure 9 and shows incubation time curves with temperature obtained for both species.

It is of interest to note that the lower temperature thresholds for both sardine (13°C) and anchovy

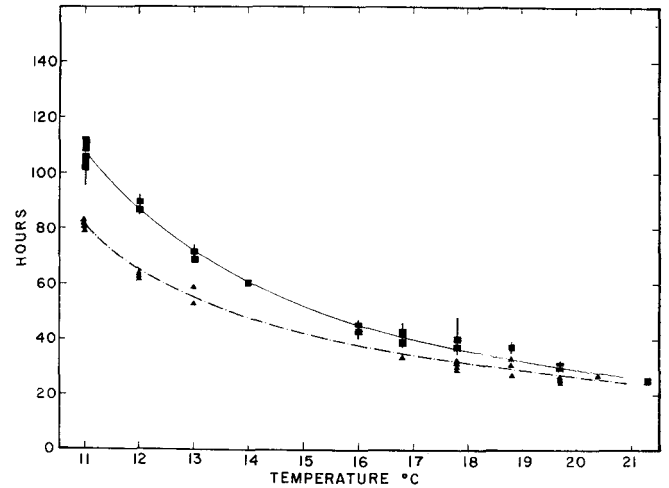

FIGURE 9. Observed incubation times for Pacific sardine and northern anchovy eggs (from stage IV). For the sardine the vertical lines indicate the range at each temperature and the bars the standard deviations around the mean;  $\Delta$  = anchovy individual.

(11°C) were determined and the effect of temperature on incubation time were deduced from field collections by Ahlstrom (1943, 1956). These have largely been borne out by laboratory results. A comparison of incubation times with temperature obtained by the two methods is given in Table 6.

TABLE 6  
INCUBATION TIMES OF PACIFIC SARDINE EGGS AT DIFFERENT TEMPERATURES. LABORATORY STUDIES COMPARED WITH FIELD STUDIES  
(Lasker, 1964)

Temp. °C	Incubation time in hours* (this study)	Incubation time in hours (Ahlstrom, 1954)	Percent difference†
11	140	114	18.5
12	115	100	13.0
13	93.0	88	5.3
14	78.5	77	1.9
15	68.1	68	0.1
16	60.2	60	0.3
17	53.7	53	1.3
18	48.4	46	5.0
19	43.2	41	5.1
20	39.3	36	8.4
21	34.0	31	8.8

\* Corrected for time from spawning to stage IV based on field observations by Miller (1952).

† Percent difference is calculated by dividing the difference in hours at a temperature with the time found experimentally ( $\times 100$ ).

## DISCUSSION

In 1926, Hjort, in discussing the concept of the "critical period" suggested "that those individuals which at the very moment of their being hatched did not succeed in finding the very special food they wanted would die from hunger. That in other words the origin of a rich year-class would require the contemporary hatching of the eggs and the development of the special sort of plants or nauplii which the newly hatched larvae needed for its nourishment." As this presentation has shown, the sardine larva

seems to fit this pattern in most of its details. Toward the end of yolk absorption and before feeding, the larva is on an energy deficit. This becomes particularly acute when the yolk is completely gone. The timing of development and the metabolic deficit are in delicate balance, and depending on the temperature, a day, or perhaps a few hours in the life of the larva will decide whether it will live or die. Because tissue resorption inevitably ensues, a sardine larva must encounter a particle of food soon after its mouth is formed if it is to have enough energy for succeeding food excursions. It also seems that this encounter may be a chance affair because the larva has not yet fully developed its vision (Schwassmann, this symposium) for accurate hunting.

A true "critical period" for a Pacific sardine larva could be the result of the lack of copepod nauplii or other suitable food organisms of the proper size and in sufficient density to ensure contact the first or second time the sardine larva hunts for food. Dr. Schumann discusses the implication of larval behavioral aspects in relation to feeding elsewhere in this symposium.

#### REFERENCES

- Ahlstrom, E. H. 1943. Studies on the Pacific pilchard or sardine (*Sardinops caerulea*). 4. Influence of temperature on the rate of development of pilchard eggs in nature. Spec. Sci. Rept., No. 23, U.S. Fish and Wild. Ser. : 26 pp.
- Ahlstrom, E. H. 1954. Distribution and abundance of egg and larval populations of the Pacific sardine. U.S. Dept. Interior, Fish and Wild. Ser. Fish. Bull. 93:83-140.
- Ahlstrom, E. H. 1956. Eggs and larvae of anchovy, jack mackerel and Pacific mackerel. *California Cooperative Oceanic Fisheries Investigations Progress Report*, 1 April 1955 to 30 June, 1956, :33-42.
- Arthur, D. K. 1956. The particulate food and the food resources of the larvae of three pelagic fishes, especially the Pacific sardine, *Sardinops caerulea*. Ph.D. Thesis, University of California, Scripps Institution of Oceanography, : 231 pp (Typewritten).
- Hjort, J. 1926. Fluctuations in the great fisheries of northern Europe viewed in the light of biological research. *J. Cons. Int. Explor. Mer*, 1(1) :5-38.
- Lasker, R. 1962. Efficiency and rate of yolk utilization by developing embryos and larvae of the Pacific sardine *Sardinops caerulea* (Girard) *J. Fish. Res. Bd. Canada*, 19(5) : 867-875.
- Lasker, R. 1964. An experimental study of the effect of temperature on the incubation time, development and growth of Pacific sardine embryos and larvae. *Copeia*, 1964 (2) : 399-405.
- Lasker, R. and G. H. Theilacker, 1962. Oxygen consumption and osmoregulation by single Pacific sardine eggs and larvae (*Sardinops caerulea* Girard). *J. Cons. Int. Explor. Mer*, 27(1) :25-33.
- Miller, D. J. 1952. Development through the prolarval stage of artificially fertilized eggs of the Pacific sardine (*Sardinops caerulea*). *California Fish and Game*, 38:587-595.
- Winberg, G. G. 1956. [Rate of metabolism and food requirements of fishes.] Belorussian State University, Minsk. 251 pp. [*Fish. Res. Bd. Canada* Translation Series No. 194.]

# LARVAL SARDINE AND ANCHOVY INTERRELATIONSHIPS<sup>1</sup>

JOHN D. ISAACS

Scripps Institution of Oceanography  
University of California at San Diego, La Jolla, California

## INTRODUCTION

This paper presents analyses of data on the size and numbers of sardine and anchovy larvae. The analyses are a selection from a larger number carried out by the author over the last several years, selected because of the insight that they provide or in some cases, because of the useful or intriguing questions that they raise.

The data employed are the length-frequencies of anchovy and sardine larvae collected over the years 1950–57 by the CalCOFI Program and measured and reported by the Bureau of Commercial Fisheries, La Jolla, California (Ahlstrom, 1950, 1951, 1952, 1956, 1957 and Ahlstrom and Kramer, 1953, 1954, 1955).

## PURPOSES OF THE ANALYSES

The adult stocks and the entering year classes of sardines have fluctuated rather widely. In addition, the stocks of adult anchovies, as judged by their eggs and larvae, have increased greatly over the years 1950 to 1957 and later. It is quite possible that these fluctuations are determined by changes in larval survival or growth. In addition, the co-occurrence of the two species at the larval level may impose changes in the larval statistics indicative of interaction.

There is another important purpose to these studies. The numbers of larvae of a species that are taken in a survey, are dependent upon a number of poorly understood factors. These factors include net efficiency versus size of larvae, towing speed and light level; growth rate of the larvae; and larval mortality rate. Analyses were performed in an attempt to separate the effect of these factors.

## RESULTS

An understanding of some of the factors of larval growth, mortality, and escape and of the developing anchovy-sardine interaction has been gained.

The increasing dominance of anchovies over sardines during the period is shown to have taken place with:

1. a rapidly increasing anchovy larval population and a slowly decreasing sardine larval population,
2. a rapidly increasing portion of the anchovy larval population free from association with sardines,
3. a slowly increasing portion of the sardine larvae free from association with anchovies and
4. an initially rapid increase in the numbers of anchovies associated with sardines, apparently becoming constant in later years at about 6 to 1.

Thus the anchovy simultaneously achieved not only increasing numbers, but also increasing freedom and association!

During the early portions of the period—about 1951 to 1953—the degree of mixing or association of larvae decreased with increasing larval size, whereas in 1954 and subsequently, the degree of association increased with increasing size.

The success of the year class of sardine larvae may be related to the degree of association with anchovies, perhaps indicating that areas with the best conditions are inhabited by both species.

A coherent picture of escape from the net, and growth rates and mortality of the larvae of both species has been derived.

The anchovy larvae is found to escape, probably through the webbing up to a size as much as 7.75 mm in length and to escape, probably out of the mouth of the net above 9.75 mm. The sardine escapes out of the mouth of the net above 14.75 mm.

Both species largely dodge the net in daytime. In the case of the sardine larvae the day-caught larvae are shown to be a measure of mortality of the population. From this, criteria of growth and survival are derived and are found to rank years in fair agreement with the sardine year class success as determined by the fishery. A similar treatment of the anchovy larvae could not be *directly* defended because of the brief sampling interval of these larvae. Nevertheless a treatment of the anchovy larvae in this way and derivation of anchovy growth and survival criteria results in a rational picture of the relationship between the two species. There is apparently some inverse correlation between the derived survival of the two species. The years strongly advantageous to one or the other species are clearly indicated by this analysis. For example, 1952 and 1956 are shown to have been relatively advantageous to the sardine; 1955 disadvantageous to both but relatively advantageous to the sardine and all other years in the series are shown to have been relatively advantageous to the anchovy with 1951 being the most advantageous.

It was found that a direct correlation exists between the criteria of growth and survival within each species. This accounts for the slightness of the variation between years of the slope of the length-frequency statistics, despite the changes in the growth and survival. In general, rates, which are derived from ratios, display more consistency than numerical survival. This argues that the sampling is more nearly adequate for representivity than for census, as must always be the case in such sampling programs.

<sup>1</sup> All figures appear at end of paper, pages 114 to 140.

The calculated survival of sardines appears directly correlated with the size at which the larvae of the anchovy cease escaping through the mesh of the net. This is believed to result from either some inverse correlation of sardine survival with the "condition" of the anchovy larvae, a direct correlation with some associated entangling material in the catch that early prevents anchovy larvae escape through the mesh, or a direct relationship of vigor in both species.

There exists a direct correlation between survival of the sardine and the slope of the length-frequency of extremely rare, very high catches of the larvae. This indicates perhaps that significant survival occurs in very small patches of highly advantageous conditions.

An assumed exponential growth combined with the real numbers of larvae caught, results in a linear biomass growth for both species, and this can be extrapolated to the adult stocks within good agreement of their relative size over the period. This suggests that larval survival is the result of a limiting input, and that biomass growth is independent of larval size (that is  $dw/dt \sim w$ ).

The algebra of the effect of growth on the length-frequency diagrams is developed.

**ANALYSES**

The analyses are discussed along with the presentation of the appropriate graphs or tables. In some cases no direct conclusions can be drawn but the analyses indicate peculiarities of the data that are provocative. These are merely pointed out.

In general, as will be established later, the significant size range of sardine larvae is about 5.75 mm to 14.75 mm and for anchovy larvae the significant interval is about 6.75 mm to 9.75 mm. Where slopes or integrations are performed the corresponding intervals are decreased 1 mm. Thus the data on the anchovy is severely limited in many cases.

**SIZE OF CATCHES—FIGURES 1-8.**

Numbers of sardine larvae taken in each net haul for each year are plotted versus length. Curve A is the average numbers of all positive hauls taking larvae at that length and Curve B is the median of all positive hauls.

For the larger larvae the numbers reported in the literature are in some instances influenced by aliquoting the samples. The largest number of large larvae found are usually the result of multiplying some very small number of larvae, (usually one), by the reciprocal of the aliquot fraction. This figure appears in the basic data, and there is no satisfactory statistical way to correct for it. Thus, the flattening of the curves from 15.75 mm on to greater lengths results from aliquoting and hence is not significant at the smaller sizes; where the larvae are more numerous, aliquoting introduces no such difficulty.

The following table summarizes the slopes of these curves.

**TABLE 1**  
**LOG SLOPES OF LARVAE CATCH DIAGRAMS**

	(1) Slope Extreme	(2) Slope Upper N	(3) Slope $\Sigma N_N$
1950-----	0.94	1.01	0.84
1951-----	0.70	0.84	0.74
1952-----	0.49	0.87	0.82
1953-----	0.60	1.04	0.86
1954-----	0.74	0.90	0.86
1955-----	0.80	0.86	0.87
1956-----	(0.17) 0.57	0.92	0.85
1957-----	0.89	0.89	0.77
Average-----	0.717	0.917	0.827

Slopes,  $\frac{\Delta \log N}{\Delta L}$

By way of explanation, the extreme was the extreme line that could be drawn through the uppermost separated points; the upper N was the average of the highest N number of samples in each size category, where N was the number of cruises in that year; and  $\Sigma N_N$  is the sum of all night samples at each length. (The slopes of the latter sum, are, of course, the same as the slopes of the night catch; i.e., from Figures 31-38, presented later.)

In the simple case, the slope of these lines might be thought of as a measure of mortality of some portion of the population. Hence, if larval survival were important to the development of a year class the years that were apparently years of relatively good year class survival (i.e. 1952 and 1956) would have small values of slope, and years that appear to be particularly poor years (i.e. 1950 and 1955) would have large values of slope. An inspection of the table of slopes indicates that none of these measures displays such relationships among the years, except for the slopes of the extreme. This, indeed, shows such a very flat slope for the year 1956 that the second extreme for that year is also recorded and it is still the second flattest slope in this series.

Perhaps the most intriguing aspect of these presentations is this existence of extremely high concentrations at a few lengths. For example, in Figures 3 (1952) and 7 (1956), there are several points that represent only a small decrease over the highest concentrations of very small larvae. These could be interpreted as the result of schooling behavior with increasing size. If this were the case, the effect of schooling should not be limited and it would seem reasonable to find occasional catches of large larvae that were greater than any catches of smaller larvae. Only in 1957 is there the suggestion of such a case but it involves comparison of only very small larvae. In most cases the extreme concentrations of large larvae is merely slightly less than the extreme concentration of smaller larvae.

An alternative explanation is that in these cases we are observing an occasional sample from a region of very high concentration and very high survival. It is not unreasonable that this might be so. The entire population of adult sardines easily could be re-

produced by extremely high survival in small patches that were much smaller than the grid of the survey pattern and hence only occasionally sampled. Such patches would presumably represent a maximum number of advantageous factors and a minimum number of disadvantageous factors.

That is, to explain these results we may suppose that the sardine survival results from small isolated patches a few square miles in extent where there is optimum food, a minimum of predators, a minimum of competitors, and other optimum conditions. If we consider the great number of factors that must influence the survival of larval sardines, and the spottiness of the distribution of these factors, there must be rare areas where an unusual concert of advantageous conditions is combined with a virtual absence of adverse conditions over a significant period of time.

That such circumstances could control the year class success is not so surprising.

If we were to try to reforest a great area by profligate seeding from aircraft we would not be surprised to discover most of the reproduction in very small well-defined areas where recognizable conditions greatly favored survival. It is by no means farfetched that similarly profound but virtually invisible conditions at sea lead to similar rare spots of unusual survival. Indeed if the apparent survival in these few extreme points is extrapolated to 180 mm by log linear extrapolation (i.e.  $\log N' = CL$ ), the surviving fish are of the order of  $10^{10}$ , quite in accord with the order of requirements of sardine recruitment. Add to this the superficial correlation of slope and apparent year class success between years and this hypothesis is not unattractive.

It should be noted that these rare large samples at early times are not a very large part of the total larval sardine catch. Their influence on the slope of the average curves is small and an average survival applied to these extreme concentrations will, of course, show only a slight survival.

An examination of the zooplankters associated with two of these high concentrations of sardine larvae reveals a mixed zoogeographical group of zooplankton. This group differs from adjacent stations in possessing fewer species of copepods including fewer predaceous species (Fleminger, 1963). This will be published later.

Later in this paper will be developed an hypothesis leading to the establishment of growth and mortality criteria for the general population of sardine larvae. These criteria are not derivable from single samples as they involve an interpretation of related day catches and night catches. However, there will be shown a correlogram (Fig. 65) of the mortality criterion for the year and the extreme slope. The correlation is reasonable, and especially so when one considers the rare nature of the samples upon which the extreme slope is based.

#### ANCHOVY AND SARDINE CATCHES— Figures 9, 10, 11, and 12

These figures consist of plots of all catches of sardine and/or anchovy larvae for the years 1950, 1952,

1955 and 1957. Numbers of larvae of each species for each catch are plotted against the numbers of the other species occurring in the same catch. The anchovy larvae were inadequately sampled in 1950, so this plot is somewhat biased toward sardine larvae. (In all drawings, points representing pure catches are sometimes "stacked" off the axis. The zero axis is intended in these cases.)

The trends over these years are conspicuous in these plots.<sup>1</sup> In 1952 there are many pure catches of sardines and many mixed catches as well as many pure catches of anchovies. The largest numbers of sardines are associated with anchovies! (Later it will be indicated that the high survival and growth of sardines may occur in the regions that the two species co-inhabit.) As time progresses, however, as shown in 1955 and 1957, the diagrams rotate toward the anchovy axis. Large pure catches of sardine larvae decrease dramatically, mixed schools have a greater proportion of anchovies and the pure catches of anchovies increase greatly. During this period the surveys were increasingly concentrating on the areas where sardines were abundant and hence the indicated trend was undoubtedly even more extreme.

Apparently any competition between the species takes place with an association that is at least sufficiently intimate to allow their larvae to be taken in the same oblique plankton hauls very frequently.

#### ANCHOVY-SARDINE RELATIONSHIPS WITH LENGTH—Figures 13–19 and 20–26

Another parameter in this association of anchovy and sardine larvae is the relation of the association with length. These are shown in Figures 13–26, where all larvae from night hauls are compared both in total (labeled night) and those from night hauls in which the other species was also present. The two sets of curves are of course not wholly independent, for associated anchovies, of course, imply the existence of associated sardines. However, the sets of curves are not entirely dependent as each one reflects the numbers of the particular species involved, and not the numbers but only the presence of the other species.

In comparisons of numbers at related lengths in different years the significant interval of sampling, discussed above, is not necessarily pertinent.

It is seen that for both species the relative association tends to decrease with increasing length for the years 1951, 1952 and 1954, (that is, the curves diverge), where as the opposite trend (convergence of the curves) obtains for both species for 1953, 1955 and 1956. (The 1957 graph for sardines is a possible exception.) The simplest explanation for convergence of the curves is an increasing dispersion and mixing of both species and perhaps increased co-schooling with increasing age. In the cases (1951, 1952 and 1954) where the curves diverge it is difficult to conceive of a simple dominant process by which the two species can become *less* associated with increasing age.

<sup>1</sup>The particular years selected for these diagrams display the trends but not the range of variations between years. Figures 27–29 show 1951 to have been a critical year, and 1954 and 1956 interesting. Similar plots of these years will be undertaken later.



Several factors could, however, account for the trend, including an increasing relative growth rate or decreasing relative mortality of the anchovy versus the sardine with age. Such a relationship in these years does not appear in subsequent analyses, however. A dispersion of one species and a schooling of the other could also account for the trend.

The principal conclusions of these diagrams are: (1) that over the majority of years the association of the two species tends to increase with age, and (2) that over the period the anchovy at all lengths becomes increasingly independent of the sardine whereas the sardine remains closely associated with the anchovy. To say this latter in a somewhat different way: there develops a large, unassociated population of anchovies at all lengths but not one of sardines.

This conclusion is essentially the same as that derived from Figures 9-12, but shows those conclusions to apply to all the ages sampled rather than only to the population as a whole. (See also footnote above.)

**ANCHOVY AND SARDINE NUMBERS VERSUS YEARS—Figures 27-29**

These figures demonstrate the onset and development of association even more dramatically. These figures cover the sums of larvae over only the length interval 6.75 to 9.75 mm for both species (i.e. the length interval of adequate sampling for the anchovy).

In Figure 27 the basic data are presented. It is seen that the numbers of pure sardines increase slowly over the period while the numbers of pure anchovies increase rapidly. The numbers of associated sardines and the numbers of sardines decrease with a two-year oscillation, the numbers of anchovies and pure anchovies increase throughout the period. Associated anchovies reach a peak in 1954 and level off subsequently.

Figure 28 shows these data as simple ratios. The number of associated sardines as a proportion of the total sardines decreases with a similar two-year oscillation, and with peaks above the trend in 1951, 1952, 1954 and 1956. The number of associated anchovies as a proportion of total anchovies similarly decreases. However, the ratio of the associates of the sardine larvae (i.e. associated anchovy larvae plus total sardine larvae) to the sardine larval numbers increases constantly with a sudden minimum in 1956. (This latter ratio reflects the average environmental pressure on sardine larvae from the combined larvae and/or adults of the two species.)

*Thus the anchovy larvae achieve an increasing freedom and an increasing association with the sardine larvae simultaneously!*

Figure 29 demonstrates the increasing dominance of both associated and total anchovies to associated and total sardines. These ratios with a brief respite in 1956 reach continuously higher levels.

The third curve of Figure 29 is the average of the ratio of these two previous ratios. This ratio is a com-

parison of the degree of association of the two larvae in the total area. (That is:

$$\frac{N_{aa}}{N_a} = K \frac{N_{sa}}{N_s} ; \text{ where } K \text{ is this third ratio.}$$

It is seen that this ratio varies between about 0.4 and 0.7 through 1955 and then declines abruptly for 1956 and returns to a higher level in 1957. The anchovy thus had only about half the degree of association as did the sardine during the years and much less in the year 1956. This is clearly another portrayal of the "breakthrough" of the population of anchovies which achieved increasing independence, while still maintaining a high level of competition.

It will be indicated later that the sardine may have suffered high larval mortality and slow growth in the year 1955. In 1955 the anchovy also apparently did not have an increasingly successful year. The anchovy subsequently recovered, however, and the sardine subsequently declined. (The year 1955 was the coldest year in a cold persistent period.)

At this point it should be noted that if the interactions of the two species were a purely random overlap of the two populations without serious effect on one or the other, the value of K should be a ratio of the magnitude of the environment occupied by the sardine larvae (and spawning adults) in respect to that occupied by the anchovy. This follows from the following argument.

Let  $E_s$ ,  $E_a$  and  $E_{as}$  be some appropriate quantitative measure of the size of the environment for the sardine, anchovy and the overlapping populations respectively.

Then  $\frac{N_s}{E_s} = \frac{N_{sa}}{E_{as}}$  and (1)

$$\frac{N_a}{E_a} = \frac{N_{aa}}{E_{as}} \quad (2)$$

Thus  $\frac{N_{aa}}{N_a} = \frac{E_s}{E_a} \times \frac{N_{sa}}{N_s}$  (3)

and  $\frac{E_s}{E_a} = K$  (3.1)

If, however, the overlap were still random but both of the larvae were equally interacting in the region of overlap (including the effects on the larvae of the presence of the adults of the two species) in a manner similar to some limiting effect on the separate populations, then:

$$\frac{N_s - N_{sa}}{E_s - E_{as}} = \frac{N_{sa} + N_{aa}}{E_{as}} \quad (4)$$

and  $\frac{N_a - N_{aa}}{E_a - E_{as}} = \frac{N_{sa} + N_{aa}}{E_{as}} \quad (4.1)$

solving,  $\frac{E_s}{E_a} = \frac{N_s + N_{aa}}{N_a + N_{sa}}$

It would be intriguing to compare such models with some quantitative measure of the environments occupied by the two species. The difficulty in doing this stems from selecting a measure. The environment of a pelagic creature can thin, thicken, spread or contract. Thus area is probably a poor measure of extent of the environment. This particular difficulty would be corrected by selection of a volumetric criterion. The plankton nets, of course, sample volumetrically, but this in no way guarantees that the volume sampled in a series of positive hauls has described the volume of the environment, for the appropriate environment can occupy only a portion of the depth range sampled. Even were the appropriate volume to be sampled adequately, the environment is not necessarily measured by the volume of water but may concentrate or attenuate in disregard to the quantity of water present.

Despite these difficulties, it would be interesting to compare the models suggested above (along with others that can be developed) with possible measures of the environment.

In respect to the first of the two models it is difficult to imagine that the "size" of the environment of the sardine has only varied between 0.4 and 0.7 of that of the anchovy, for the relative areas occupied by the two species have changed much more than this. Despite the inadequacy of area as a criterion, very large changes in area are undoubtedly significant. The second model varies only somewhat more (about 0.3 to 0.6).

Thus, the *prima facie* appearance is that neither model holds and thus the region of overlap is not random. Whether or not the two species interact is not determined by this particular analysis.

### LENGTH-FREQUENCY ANALYSIS—Figures 30–56

Figures 30–47 show the catches of the two species (sardines and anchovies respectively) plotted as numbers versus length. Curve A is the total catch. Curve B are those larvae taken in daytime hauls<sup>2</sup> and Curve C are those taken in nighttime hauls. (Numbers have been halved where the length interval was two mm i.e., 17.25, 19.25, and 21.25 mm.)

The remainder of this discussion will concern itself almost solely with some of the numerous matters derivable from this set of graphs.

In the case of the sardine it is seen that the curve of the day catch (B) begins at a greater number than the night catch (C) and then drops rapidly always falling below the night catch by the second or third size category. The night catch, however, shows an early maximum at the second or third size category.

In the case of the anchovy the day catch is often practically a straight line from the beginning and is larger than the night catch only in the case of 1952. The night catch passes through a maximum at a larger but still early size category. The day catch

<sup>2</sup> The total number of dayhauls has differed only a few percent from the number of nighthauls (i.e. ~ 3%). There has been no correction for this small difference.

only twice shows a maximum subsequent to the first point.

As will be shown later for *sardine* larvae, the day catch is a measure of mortality. Thus an inferred explanation of this portion of the *anchovy* curves is as follows. The anchovy eggs and the small anchovy larvae are known to escape through the webbing of the net. This mode of escape becomes impossible for all cases at a size of about 7.75 mm. At night very few of the larvae can dodge the net. Most of these larvae are vigorous and the small ones can escape by wriggling through the webbing. During the day, however, most larvae dodge the net. Those that are caught are not sufficiently vigorous to escape through the webbing and hence show no maximum at the point where this mode of escape becomes impossible. An added factor in producing the higher night catch undoubtedly is the fouling effect of the greater mass of other plankton in the net, which prevents escape of many larvae.

There is considerable variation between years of the point in the night curve of anchovy larvae at which escape through the webbing apparently ceases. One is tempted to attribute this to some factor of larval condition. That is, poorer larvae escape at a greater length than do fatter larvae, or, conversely, more vigorous ones escape at a greater length than do the feebler larvae. The years rank as follows (length at termination of escape is shown in brackets):

1955, (3.50); 1953, (4.75); 1951, (5.75); 1950 and 1954, (6.75); 1952 and 1956, (7.75) with 1957 indefinite.

This "condition" factor will be compared to a criterion of *sardine* larvae survival that will be developed below and it will be found to be directly correlated.

Before discussing the curve marked D in these sets, it should be noted that in many cases of the sardine larvae the day Curve B has the characteristics of a first differential of the night catch, Curve C! The veracity of this relationship was tested in two ways. First the slope of the night curve was compared to the total value of the day curve at each point. Night curve slopes were computed across the interval employing the two adjacent points. These correlations are shown in Figures 48–56, and it is seen that the correlation is very high and with a slope of about unity. The combined results of the eight years, Figure 48, displays a particularly close correlation.

A further test of this relationship is shown in Curve D of Figures 30–38, sardines. Here, beginning at 5.75 mm, a successive summation of the day curve is added to each value of the night curve. The mathematical results of this, if indeed the day curve is a measure of mortality, should be to reconstitute the population as it would be *sampled* in the absence of mortality. In the absence of a changing growth rate, this sampled population should be constant. An inspection of Curve D for sardine larvae

Table 2  
TIME CHANGES IN SARDINE LARVAL GROWTH

	1950	1951	1952	1953	1954	1955	1956	1957
Time change.....	-0.13	-0.005	-0.165	+0.075	+0.028	+0.077	-0.308	-0.058 (-0.20)
Relative time.....	(0.87)	(0.995)	(0.835)	(1.075)	(1.028)	(1.077)	(0.692)	(0.942) (0.80)
Relative growth rate.....	1.15	1.01	1.19	0.93	0.97	0.92	1.44	1.06 (1.22) (average 1.14)

shows that Curve D is almost constant, with variation between years from a somewhat ascending slope to a descending slope.

A sampled population in the absence of any mortality will show a variation in numbers between given length intervals that depends inversely upon the comparative growth rates across the various length intervals. Thus a descending slope in Curve D is attributable to accelerating growth with increasing length and an ascending slope in Curve D is related to decelerating growth.<sup>3</sup>

In like fashion a changing growth rate will alter the slope of the correlation in Figures 48-56.

For the sardine the factor required to bring each point from 6.75 to 13.75 mm of Curve D to a constant value has been calculated and the averages of their change across the interval are shown in Table 2.

This time change factor can be considered as a *change in the time* ( $\Delta^2t$ ) required for the sardine larvae to cross a length interval as length increases. Thus values less than zero indicate accelerating growth, zero unchanging growth and values greater than zero decelerating growth. Adding unity to this value (as shown in brackets) results in a relative time across a length interval. The reciprocal of this is the growth rate criterion.

The growth rate ( $dL/dt$ ) is not derivable from any simple analysis of these data.<sup>4</sup>

In Figure 57 this growth rate criterion of the sardine is shown for each year.

The growth rates for 1957 are much more complex than in any other year of the series. At small sizes there is decelerating growth and rapidly accelerating growth at larger sizes. The average time change for 1957 is thus indefinite and could be as much as -0.2. An average relative growth rate of 1.14 will be used. The data for this year will be later tested to ascertain if it is compatible with some specific growth law.

An hypothesis to explain this curious relationship of the day-caught and night-caught larvae of the sardine is that the relationship of these larvae to

their food and predators is a highly visual one. At night the plankton net acts unlike a predator, and adequately samples the population up to a larval length of 15.75 mm. During the day, however, it acts much like a predator. Most larvae above 5.75 mm dodge the net, and the larvae that are caught are a measure of their availability to predation. This would be expected to include disproportionate numbers of the less active and visually alert, starving, maimed, moribund, and dead larvae. This category should closely represent the fraction of the population that is being removed by natural mortality.<sup>5</sup>

In regard to this relationship as it applies to the anchovy larvae, it has been pointed out that the anchovy larvae apparently escape from the nets at all sizes greater than 9.75 mm. In addition, as mentioned in the previous discussion, they escape through the net up to sizes of as great as 6.75 mm. Thus only about four intervals of length can be considered adequately sampled for the anchovy larvae. For determinations of slope the two limiting sizes must not be considered, leaving only three intervals for slope analysis. This is inadequate for a demonstration of the correlation between  $N_d/N_n$  and mortality, similar to that of the sardine. The Curves D for the anchovy uniformly display a downward slope with the exception of 1955, which is also irregular in other respects. There thus appears to be no presently satisfactory *direct* manner in which the veracity of growth and mortality measures can be demonstrated from the field data for anchovy larvae. However, the analysis can be applied to the anchovy over the limited length interval without the direct demonstration of its veracity.

In this hypothesis the length-mortality rate of the larvae is simply measured by the proportion of day-caught to night-caught larvae at each interval (that is  $-N_d/N_N$ ).

The length-mortality rate can be qualitatively altered to more closely resemble the probable time-mortality by dividing it by the growth rate criteria derived above. This qualitatively compensates somewhat for the change of time over which the mortality acts.

The values of the length-mortality rate, "compensated" mortality rate and compensated survival rates for the sardine averaged over the interval 5.75 to 14.75 are shown in Table 3.

<sup>3</sup> Curve D, of course, tends to be dominated by the large numbers associated with small sizes of larvae. The correlograms (Figures 48 to 56) show the relationship also to hold for the small numbers associated with large sizes.

<sup>4</sup> The measured time change across each interval  $\Delta^2t/\Delta L^2 \approx K$ . The growth rate criterion is  $1/(K+1)$ . In differential form, the growth rate  $dL/dt$  would be  $1/(KL+C)$ . The criterion thus assumes unity for the unknown constant factor of all growth rates. Where a significant acceleration or deceleration exists, (i.e.  $|d^2L/dt^2| > 0$ ),  $K$  dominates the growth rate after a few length intervals. Where, however, there is little acceleration or deceleration, the unknown constant continues to dominate. Thus sardine larvae growth rates in the years 1951 and 1954 may be poorly described by this criterion. 1954 is the conspicuous poorly correlated year in later analyses.

<sup>5</sup> Ahlstrom (pers. comm., 1964) has made the remarkably cogent suggestion that the larvae may dodge the net in daytime by a school-communicated response. Thus the day-catch may be an inverse measure of the degree of schooling (i.e. mainly isolated larvae are caught). The same larvae, of course, also are presumably more available to predation.

TABLE 3  
DERIVED MORTALITY AND SURVIVAL FOR SARDINE LARVAE

	1950 <sup>1</sup>	1951	1952	1953	1954	1955	1956	1957
Length mortality.....	0.276	0.276	0.213	0.349	0.202	0.344	0.153	0.333
Compensated mortality...	0.243	0.275	0.178	0.375	0.207	0.371	0.106	0.313
Compensated survival...	0.757	0.725	0.822	0.625	0.793	0.629	0.894	(alt. 0.256) <sup>2</sup> (avg. 0.286) 0.687 (alt. 0.744) <sup>2</sup> (avg. 0.715)

<sup>1</sup> The sampling in the year 1950 differed from that in subsequent years. It has not been used in some of the subsequent analyses.

<sup>2</sup> The average of the two 1957 possibilities will be used.

The survival criterion is obtained by subtraction of the above mortality from unity. Figures 58 and 59 are correlations between the two survival criteria and the growth criterion. It will be seen that correlation is excellent, 1954 being the exception, with high survival and low growth.

If these growth and mortality results were correct, one mysterious characteristic of the length-frequency diagrams of sardine larvae would immediately be explained. The slopes of these diagrams are almost unchanged from year to year, (see column 3, Table 1) despite the certainty that survival is quite different in various years. As shown in the previous discussion the hypothesis developed leads to the result that "good" years are characterized by an *accelerating* growth rate and low mortality whereas "poor" years are characterized by *decelerating* growth rates and high mortality. The effect of each of these combinations of parameters on the length-frequency diagrams is compensatory. For example, in a "poor" year a decelerating growth rate will result in the collection of successively more larvae in the samples than if the growth rate were unchanging. The effect of the associated high mortality, however, is successively to *decrease* the numbers captured, and, hence, qualitatively to compensate for the effect of growth.

If the hypothesis presented were correct, it is only through the independent measurement of mortality and growth by analysis via the day- and night-caught larvae that the differences in years become conspicuous.

The effect of growth rate on the sampled numbers is handled algebraically in later discussions.

At this point it should be noted that if the length-frequency diagrams of the larvae were truly of constant slope the assignment of a particular mortality to any year would *a priori* result in a compensatory growth history. To the extent that a constancy of slope prevails in the various years' length-frequency diagrams, the foregoing of the two sardine larvae parameters are not independent and ensue only from the mortality assumption  $N_d/N_N$ . Thus to some degree the weight of the case rests on the veracity of the ranking of the years as related to sardine success from other sources of information.

The spawning success in these years can be estimated from catch data. McGregor has estimated the size of the year class entering the fishery in billions of fish as follows: 1951—0.41; 1952—0.63; 1953—0.22; 1954—0.16; 1955—0.36; 1956—1.16; 1957—0.52.

Here the agreement with the survival rate criterion Figure 60 is fairly good with only the year 1954 poorly correlated as would be expected. The agreement with the growth criterion is better, (Fig. 61). The salient features of the history are in good agreement. The fishery statistics are, of course, incomplete and are heavily biased to the northern part of the present sardine range. Some disagreement is thus not unexpected.

A further study of these criteria as related to the stocks as determined by egg census is a logical step that is being taken.

In a final interrelation, all of the derived statistics concerning the sardine larvae growth and survival is shown in Table 4. Here for each year is calculated a number of survivors after some extrapolated period of growth.

TABLE 4  
SARDINE—SURVIVAL

Year	Mortality Rate	Survival (M) Rate	Ns	Relative Time (g)	$\frac{N_s}{g}$	5g	m <sup>5g</sup>	N'
1950.....	0.276	0.724	1490	0.87	1750	4.35	0.245	421
1951.....	0.276	0.724	2550	0.995	2562	4.97	0.200	514
1952.....	0.213	0.787	4040	0.835	4840	4.17	0.368	1777
1953.....	0.349	0.651	2160	1.075	2009	5.38	0.100	201
1954.....	0.202	0.798	3800	1.028	3690	5.14	0.312	1150
1955.....	0.344	0.656	1490	1.077	1382	5.38	0.104	144
1956.....	0.153	0.847	2896	0.693	4170	3.47	0.561	2340
1957.....	0.333	0.667	1665	0.942	1768	4.71	0.149	203
1957 (alt.)....				0.800	2080	4.00	0.198	412

The calculation is as follows:

$$N' = \frac{N_s}{g} \times m^{ng}$$

where  $N'$  are the extrapolated survivors from  $n$  growth periods;  $N_s$  is the total night-caught larvae for the year in the length interval 6.75–9.75 mm;  $g$  is the relative time criterion previously derived;  $m$  is the derived survival criterion. Since absolute time is unknown, five time intervals were chosen for  $n$  for all years so that the variation in final survival was of the order of 10, as observed in the year class from catch statistics.

In Figure 62 this calculated survival is compared to the year class. Again 1954 is poorly correlated but the salient features of the history are very well shown.

In Figure 63 this survival is plotted against the presumed measure of anchovy condition previously derived and in Figure 64 sardine growth rate is also plotted against anchovy condition. A direct correlation appears excellent. There are three possible explanations. (1) The anchovy "condition" truly represents the thinness of the preponderance of anchovy larvae, which is directly related to sardine success or (2) the escape of the anchovy larvae through the webbing is an inverse function of the quantity of certain other plankton captured by the net and the sardine success is inversely related to the quantity of this plankton or (3) the "condition" is directly related to the vigor of the anchovy larvae and also directly related to sardine success.

Before entering into the discussion of anchovy parameters, there should be presented the correlogram Figure 65 which relates the mortality criterion with the extreme slope of the individual catches of sardine larvae (see Table 1, column 1). As previously noted, the correlation is fair, especially at the extremes. It should also be noted that there is nothing incompatible between the idea of a general condition of the whole population being reflected in an exaggerated way in very small portions of the population. Thus these very small areas of high concentration of large larvae may contribute disproportionately to the ultimate entering year class.

It also should be noted that these very large concentrations are mixed with anchovies (see Fig. 9–12,

in which, except for 1957, all the extreme concentrations of sardines are so mixed).

Figure 66 correlates sardine growth and mortality with the proportion of sardine larvae associated with anchovies. The correlation is low but direct—that is in the years in which associated sardine larvae represented a large part of the sardine larval population, growth and survival rates also were high. Referring to Figure 28, it will be noted that the factor  $N_{sa}/N_s$  decreases over the years. This may result from an increasing "chasing" of sardines in the survey program. Removing this possible "bias" from the  $N_{sa}/N_s$  ratio as shown on Figure 28 results in the correlation shown on Figure 67. The simplest bias line has been chosen—the correlation is good.

This may suggest that the waters occupied by both species are more suitable to the sardine than the waters that it occupies outside the anchovies association. Presumably this has obtained only in the recent years of the increase in anchovies.

An hypothesis that the anchovy larvae "dilute" the sardine larvae in the mixed population and buffer them from predation does not yield defensible statistical results.

### ANCHOVY MORTALITY AND GROWTH— Figure 68

As discussed previously the brief length interval of sampling of this species precludes the direct demonstration of the veracity of the analysis. However, the analysis can be performed on the four length categories that appear to be properly sampled. The large numbers involved in the anchovy larvae may partly compensate for the small interval.

The results of the treatment are shown in Table 5.

As shown by Figure 68 the correlation between relative growth and survival of the anchovy is by no means as significant as that of the sardine. However, the years during which the anchovy apparently made high gains are clearly shown as well as those during which it made low gains.

There is a complete lack of correlation between anchovy "condition" previously described and either of the two anchovy criteria. This lends credence to the alternative that this "condition" is related to the entanglement in some other component of the catch that also influences sardine survival.

TABLE 5

#### ANCHOVY—MORTALITY, GROWTH AND SURVIVAL

Year	Mortality	Relative survival rate	Na	Growth criterion	Relative growth rate	Na × growth	5g	S <sup>5g</sup>	Na' survival
1951.....	0.127	0.873	8,930	0.745	1.34	12,000	3.73	0.603	7,250
1952.....	0.211	0.789	16,870	0.962	1.04	17,500	4.81	0.320	5,600
1953.....	0.164	0.836	25,750	0.953	1.05	27,000	4.77	0.425	11,500
1954.....	0.122	0.878	45,000	0.894	1.12	51,200	4.47	0.559	28,600
1955.....	0.490	0.510	30,000	1.037	0.97	28,900	5.18	0.031	895
1956.....	0.166	0.834	45,700	1.00	1.0	45,700	5.00	0.404	18,800
1957.....	0.181	0.819	44,340	0.979	1.02	45,300	4.89	0.369	16,700

### COMPARISON OF ANCHOVY AND SARDINE GROWTH AND SURVIVAL—Figures 69–71

It is now possible to compare these derived parameters between the two species.

In Figure 69 is shown a comparison of relative growth rates of the anchovy and sardine. There appears to be some negative correlation. If we may except the year 1955, during which *both* species apparently did poorly, the negative correlation is rather good.

On this Figure 69 is marked the 1:1 line separating conditions relatively advantageous to one or the other species. The years are clearly separated in good agreement with the experience.

A similar comparison between survival rate of the two species is shown in Figure 70. Here the survival rate has been extended over five and ten length intervals in two plots. Again the years are separated in a rational way between those relatively advantageous to one or the other species.

Again excepting 1955 there appears to be a negative correlation in the five interval plot that is emphasized when extended to ten intervals.

All lines connecting points for the same year, of course, continue to diverge from the 1:1 line. Thus the inverse correlation would become stronger as the rates were further extended.

Figure 71 extends the growth and survival calculations to include the numbers of larvae sampled. The line separating relatively advantageous and disadvantageous conditions for the two species undoubtedly should be placed on the 1:1 position. However, this shows all years relatively advantageous to the anchovy, (as is undoubtedly the case). However a line is transferred from the relative survival graph (Fig. 70) along the 1:10 position to show relatively advantageous *conditions* over the period. This, of course, shows the relative advantages of the two species to vary much in the same fashion as do the previous comparisons.

These comparative studies of sardine-anchovy growth and survival appear to present a rational picture of the history with considerable agreement and little conflict with indications from other sources. This lends support to the veracity of the treatment and to its applicability to the anchovy data as well as to that of the sardine.

### BIOMASS GROWTH OF SARDINE AND ANCHOVY LARVAE

The following discussion covers some exploration into the dimensional analysis of larval growth.

#### A. *Effect of growth on numbers sampled*

The length-frequency diagrams discussed above are a presentation of the numbers of larvae sampled ( $N_s$ ) across a series of 1 mm length increments (or adjusted to 1 mm length increments).

However, for a given number of larvae developing in the environment ( $N_e$ ) the numbers sampled at each increment will be influenced by the length

of time that the larvae spend within each growth increment.

Thus for a given sampling effort

$$N_e \sim \frac{N_s}{\Delta T_L} \quad (1)$$

where  $\Delta T_L$  is the time interval associated with a particular length interval. This is a reflective correction to an original bias in the data that is necessary to examine the implications of any assumed growth law.

Thus the general decrease of sampled numbers versus length can be made up of two components: one the true mortality of the larvae and the other a changing rate of growth of length as it affects capture of larvae within length increments. Note that an accelerating growth rate decreases the number captured at the greater lengths and a decelerating growth rate increases such numbers.

Thus, to reiterate, in a year of accelerating growth and low mortality, (which we might consider highly advantageous for the species) the length frequency diagrams are not much changed from a presumably disadvantageous year in which high mortality and low growth rate prevailed, for each of the two effects in each of the years rotate the length-frequency diagrams in opposing direction.

Mortality and growth rate could be placed in a more meaningful context if the numbers of larvae were converted to relative biomass.

For populations of a series of geometrically similar larvae this can be approximated by the following assumption:

$$w \sim L^3, \text{ where } w \text{ is the weight of individual larvae.} \quad (2)$$

Thus

$$N_s L^3 \sim W_s, \text{ where } W_s \text{ is the total biomass sampled} \quad (3)$$

during the reporting period; (actual laboratory measurements of sardine and anchovy larvae weight vs length result in exponents of about 3) (Figure 72).

In order to convert  $W_s$  into a measure of  $W_e$ , (the total biomass in the environment), it is necessary to measure or to assume some growth law.

### ASSUMPTION OF A GROWTH LAW

A series of different models are assumed for the nature of the distribution of food in the sea and the nature of the larval feeding habits.

A further assumption is that larval growth rate is a linear function of the rate of food intake  $dQ/dt$ , that is:

$$\frac{dw}{dt} \sim \frac{dQ}{dt} \quad (4)$$

All models that assume food intake to be a function of a continuous swimming effort on the part of the larvae, result in growth laws of the form:

(5)

$\frac{dL}{dt} \sim L^n$ , where the exponent  $n$  is  $1/3$ ,  $4/3$ , or  $-5/3$  or  $10/9$  for a filter feeding, and three selective feeding models respectively.

When swimming velocity of the larvae is considered non-restricting, and the food intake determined only by some portion of the larval capacity,  $n = 1$ .

or  $\frac{dL}{dt} \sim L$ , (5.1)<sup>6</sup>

$\frac{dw}{dt} \sim w$ , (6)<sup>6</sup>

and this states that each unit of mass in the larval fish population possesses an equal opportunity for growth regardless of the size of the larva of which it is a part.

The several derived equations from this type of growth follow:

$\frac{\Delta L}{\Delta T} \sim L$ ;  $\Delta T \sim \frac{\Delta L}{L}$  (7), (7.1)

$T = C + K \log L$ , where  $T$  is progressive developmental time (age), and (8)

$w = w_0 e^{Kt}$  (9)

It is possible to use the law in connection with the observed numbers in the following way:

$N_e \sim \frac{N_s}{\Delta T} \sim N_s L$  ( $\Delta L$  being a constant) and, (10)

neglecting  $C$  in equation (8),  $T \sim \log L$  (11)

since also  $W_e \sim N_e L^3$  (12)

Then  $W_e \sim N_s L^4$  (12.1)

Within the above assumptions, therefore, it is possible to plot relative biomass in the environment versus age, by plotting the sampled numbers of larvae ( $N_s$ ) multiplied by  $L^4$ , vs  $\log L$ , as seen in Figures 73 and 74.

When this is done the curves assume a wholly new character. Both species display a steeply ascending straight line with a sharp peak, followed by a steeply descending straight line.

<sup>6</sup>In this context, it should be noted that if the presentation of larval data in the usual way (as numbers sampled vs equal intervals of length) were viewed as a mortality curve vs age, this is tantamount to the assumptions:

$\frac{dL}{dt} \sim K$ , and  $\frac{dw}{dt} \sim w^{2/3}$ .

Figures for total years are shown for the two species.

The sharp maximum for sardines occurs at 14.75 mm and that of the anchovy at 9.75 mm. From other evidence it appears that the decreasing leg of the curve is the result of escape from the nets. This thesis can be examined (along with the veracity of a straight line extrapolation of the ascending portion of the curve) by the following argument:

1. Since all data used are night-catch only, escape from the net is probably related to the ultimate swimming speed of the larvae, and results from some tactic, such as swimming out of the net after entering.

2. The reason for a steeply descending curve of catch (rather than a complete cut-off), once a size is achieved at which some larvae can escape, may be due to variations in the speed of tow of the net.

3. If all of the above obtains, then the two species should "measure" the variations in net speed in the same way, and a plot of per cent escaping at each length measured from the extrapolated branch versus  $U$  as measured by  $L^{1/3}$  (see appendix) should result in a pair of parallel curves for the two species (i.e., two curves related by a single constant).

The two curves are closely parallel, as shown in Figure 75. Thus, the results are not inconsistent with the assumptions that the ascending branch of the curve is a reasonable measure of biomass increase of the larval population vs time and can be extrapolated, and that the descending branch is the result of escape.

Two particularly important results should be emphasized:

1. A law of growth that results in exponential growth of the individual when applied to the real numbers collected, is almost exactly modified by these real data to show a linear growth of biomass of the population!

2. The presentation shows the biomass of the anchovy larval population increasing more rapidly than that of the sardine, as is apparent from other sources.

3. The straight line extrapolation of the total curves to 180 mm in length yields a ratio of biomass of anchovy to sardine adults of about 8.1 to 1, which is very close to estimates from other data for these years.

From these results a number of further questions can be asked. Do these results imply that there is a fixed limited rate of input of food material into the population? It is, also, intriguing to consider whether, over the long term, populations of clupeoids increase their biomass linearly with time up to sexual maturity; and also the related question: is the length at which sexual maturity is reached for the species determined by the penultimate length at which not-less-than linear biomass growth of the population can be maintained over the long run?

It is possible that this presentation of the larval data approximates the truth.

Some possible simple models are shown in Table 6.

TABLE 6  
PARAMETERS OF GROWTH MODELS

(1) Usual Plot (Length-Frequency)	(2) Filter Feeding Mode	(3) Intermediate Mode	(4) Capacity or Food Source Limited
$\frac{dw}{dt} \sim w^{6/9}$	$\frac{dw}{dt} \sim w^{7/9}$	$\frac{dw}{dt} \sim w^{8/9}$	$\frac{dw}{dt} \sim w^1$
$\frac{dL}{dt} \sim L^0$	$\frac{dL}{dt} \sim L^{1/3}$	$\frac{dL}{dt} \sim L^{2/3}$	$\frac{dL}{dt} \sim L^1$
T $\sim L^1$	T $\sim L^{2/3}$	T $\sim L^{1/3}$	T $\sim \log L$

## CONCLUSION

The salient results of this inquiry are included in the early portions of this paper.

The paper is essentially exploratory and, thus, throughout the paper various indications are pointed out. Many of these are somewhat contradictory, others require further statistical and field investigations to decide between alternatives or to verify the results.

Perhaps the most important development and verification required is that for the growth and mortality criteria that are apparently derivable from the remarkable relationship of day- and night-caught larvae.

In this connection, the analyses were based on the data from the critical years 1951 through 1957. Similar data for the years 1958 through 1963 have not been published. It will be important to carry on these analyses through this latter period. There is one possible difficulty, however. During this latter period the sardine larvae continued to decrease in numbers. Already in 1957 the numbers sampled were low and there is a concomitant irregularity of the length-frequency diagrams and the relationships derived from these. If this irregularity stems from the small numbers of sardine larvae sampled, increasing irregularity of relationships can be expected in the latter period, and an increasing uncertainty of the derived parameters.

Perhaps the best test of the veracity of these relationships will ensue not from the data of 1958 through 1963 but from some other data on pelagic fish larvae. The future CalCOFI surveys should perhaps be altered to obtain larger and more nearly representative samples of the two species, and the test of veracity can then be applied to these.

At the same time there is a requirement to place the analysis of these data on a sounder analytical basis. For example, the presented analyses of growth rate are limited to an estimate of the acceleration of the time rate of change of length. (i.e.,  $d^2L/dt^2$  the second differential of length with respect to time). Where this is significantly different from zero, the second differential greatly affects the rate after a short period. Where it is close to zero, (1954 for sardines for example), the lack of knowledge of the growth rate (i.e.  $dL/dt$ ) is a more serious deficiency. An attempt

will be made to arrive at a more sophisticated treatment of growth and mortality rates, and to fit the data into experimental and theoretical growth models. Included in this will be the biomass growth models explored in this paper.

Barely mentioned in the foregoing is any correlation between the growth and mortality criteria of the two species, their spawning stocks, the biological associates, and the oceanographic conditions. These growth and mortality criteria (especially in relative form between the two species) constitute objective measures for comparison with the ecological factors. A great continuation of work needs to be carried out in this area, and is being undertaken.

Confirmation and further development of the day-night relationship would permit the management of a pelagic fishery on a year to year basis rather than by the slow accumulation of catch statistics. Independent inquiry into its veracity and applicability, thus, becomes an important matter.

## ACKNOWLEDGEMENTS

This paper represents one of the results conducted under the Marine Life Research Program, the Scripps Institution of Oceanography's part of the California Cooperative Oceanic Fisheries Investigations, which are sponsored by the Marine Life Research Committee of the State of California.

The author wishes to acknowledge the great aid in many of the foregoing calculations of Paula Chambers, Nancy Begnoche, Sandra McArthur, Steven Goss and Ann Katherine Isaacs. He also gratefully acknowledges the patience and help of Lorayne Buck in multitudinous typing and retyping the manuscript; Julian Miller for the careful determinations of larval weights; and the interest and council of Dr. Elbert H. Ahlstrom, Dr. Milner B. Schaefer, Walter R. Schmitt, Garth I. Murphy and others.

## REFERENCES

- Ahlstrom, Elbert H. 1950. Pilchard eggs and larvae and other fish larvae, Pacific coast, 1950 *U.S. Fish and Wildlife Service, Spec. Sci. Report-Fisheries* No. 80, 58 pp.  
 1951. Pilchard eggs and larvae and other fish larvae, Pacific coast, 1951. *U.S. Fish and Wildlife Service, Spec. Sci. Report-Fisheries* No. 102, 55 pp.  
 1952. Pacific sardine (pilchard) eggs and larvae and other fish larvae, Pacific coast, 1952. *U. S. Fish and Wildlife Service, Spec. Sci. Report-Fisheries* No. 123, 76 pp.  
 1956. Sardine eggs and other fish larvae, Pacific coast, 1956. *U.S. Fish and Wildlife Service, Spec. Sci. Report-Fisheries* No. 251, 84 pp.  
 1957. Sardine eggs and larvae and other fish larvae, Pacific coast, 1957. *U.S. Fish and Wildlife Service, Spec. Sci. Report-Fisheries* No. 323, 99 pp.  
 1964. Personal Communication.  
 Ahlstrom, Elbert H. and David Kramer. 1953. Pacific sardine (pilchard) eggs and larvae and other fish larvae, Pacific coast, 1953. *U.S. Fish and Wildlife Service, Spec. Sci. Report-Fisheries* No. 155, 74 pp. 1954. Sardine eggs and larvae and other fish larvae, Pacific coast, 1954. *U.S. Fish and Wildlife Service, Spec. Sci. Report-Fisheries* No. 186, 79 pp.  
 1955. Sardine eggs and larvae and other fish larvae, Pacific coast, 1955. *U.S. Fish and Wildlife Service, Spec. Sci. Report-Fisheries* No. 224, 90 pp.  
 Fleminger, A. 1963. Work in progress.



## Appendix

### POSSIBLE GROWTH RATES OF LARVAL FISH

#### A. GENERAL ASSUMPTIONS

1. Throughout a series of similar larvae, the power output per unit weight is a constant at any behaviorally similar speed (i.e. ultimate speed, feeding speed, etc.).

$$P \sim W \quad (1)$$

2. The hydrodynamic drag of a larva is determined by its area and the square of its velocity.

$$F_d \sim AU^2$$

3. In a series of similar larvae of different lengths all volumes and weights are related to the cube of length, all areas by the square of length and all dimensions by the length.

$$W \sim V \sim L^3 \quad (3)$$

$$A \sim L^2 \quad (4)$$

$$L_1 \sim L \quad (5)$$

4. The feeding velocity of a larva is a velocity at which the power output,  $P_o$ , is constantly related to the internal power capacity,  $P_i$ .

$$P_i = P_o \quad (6)$$

$$P_o \sim AU^3 \sim L^2U^3 \quad (6.1)$$

$$P_i \sim W \sim L^3 \quad (6.2)$$

$$L^2U^3 \sim L^3 \quad (6.3)$$

$$U \sim L^{1/3} \quad (7.0)$$

5. The time rate of weight growth is proportional to the time rate of food intake.

$$\frac{dW}{dt} \sim \frac{dQ}{dt} \quad (8.0)$$

#### B. ASSUMPTIONS OF FEEDING CONDITIONS AND FEEDING BEHAVIOR

##### Case No. 1

The ocean contains uniformly distributed fine particles. The larvae feed by swimming at some constant power-to-weight output and capture a fixed proportion of the particles in a column of water whose cross sectional area is proportional to the mouth area of the larva.

$$\frac{dQ}{dt} \sim AU \sim L^2 L^{1/3} \sim L^{7/3} \sim w^{7/9} \quad (9.0)$$

$$C_1 \frac{dw}{dt} = L^{7/3} \quad (9.1)$$

$$C_1 \frac{d(C_2L^3)}{dt} = L^{7/3}$$

$$3C_1C_2L^2 \frac{dL}{dt} = L^{7/3}$$

$$3C_1C_2 \frac{dL}{dt} = L^{1/3} \quad (9.2)$$

$$T = 3C_1C_2 (L^{2/3} + C) \quad (9.3)$$

##### Case No. 2

The ocean contains equal weight quantities of food at each size over the appropriate range. The larvae randomly select these particles at their feeding velocity without regard to the size.

$$C_1 \frac{dw}{dt} = L^{1/3}$$

$$C_1 \frac{d(C_2L^3)}{dt} = L^{1/3}$$

$$3C_1C_2 \frac{dL}{dt} = L^{-5/3}$$

##### Case No. 3

The ocean contains a continuous size spectrum of food particles with an equal density of *numbers* of particles of each dimension over the appropriate range. The larva selects particles of a size associated with the dimensions of its mouth at a time rate associated with his velocity.

$$\frac{dQ}{dt} \sim L^3 U \sim L^3 L^{1/3} \sim L^{10/3} \sim w^{10/9} \quad (10.0)$$

$$C_1 \frac{dw}{dt} = L^{10/3} \quad (10.1)$$

$$C_1 \frac{d(C_2L^3)}{dt} = L^{10/3}$$

$$3C_1C_2 \frac{dL}{dt} = L^{4/3} \quad (10.2)$$

##### Case No. 4

The ocean contains a continuous size spectrum of food particles with equal *quantities* (by weight) of each size. The larvae feed with the velocity associated with the length and select appropriate-sized particles at a range associated with the larval volume.

$$\frac{dQ}{dt} \sim \frac{L^3U}{L} \sim L^{7/3} \sim w^{7/9} \quad (11.0)$$

This case is equivalent to Case No. 1.

##### Case No. 5

The larva's food intake is not related to his swimming ability but only to his volume capacity.

$$\frac{dQ}{dt} \sim L^3 \sim w \quad (12.0)$$

$$\frac{dw}{dt} \sim w \quad (12.1)$$

$$\frac{dL}{dt} \sim L \quad (12.2)$$

$$T = C_1 \log L + C \quad (12.3)$$

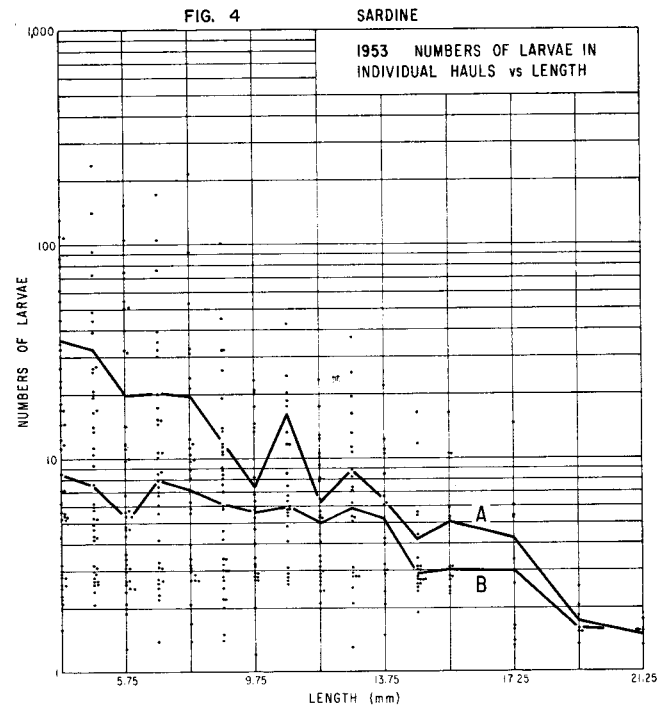
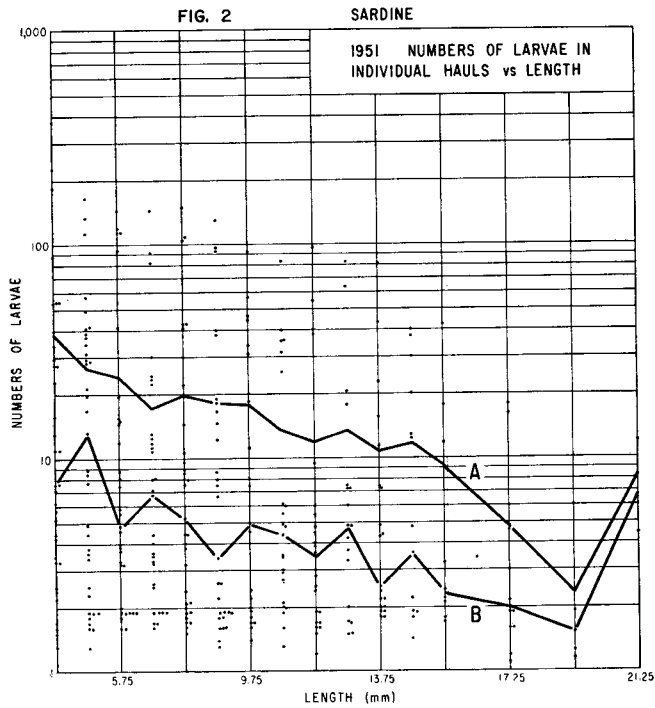
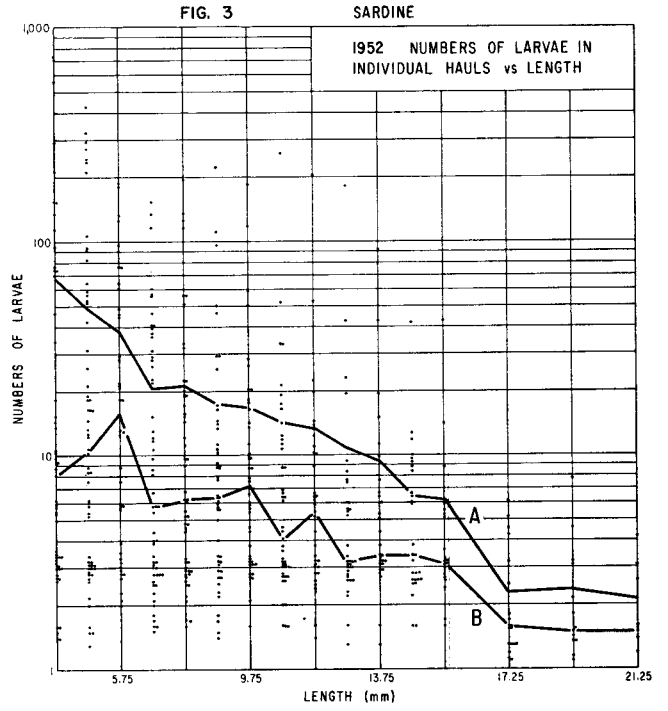
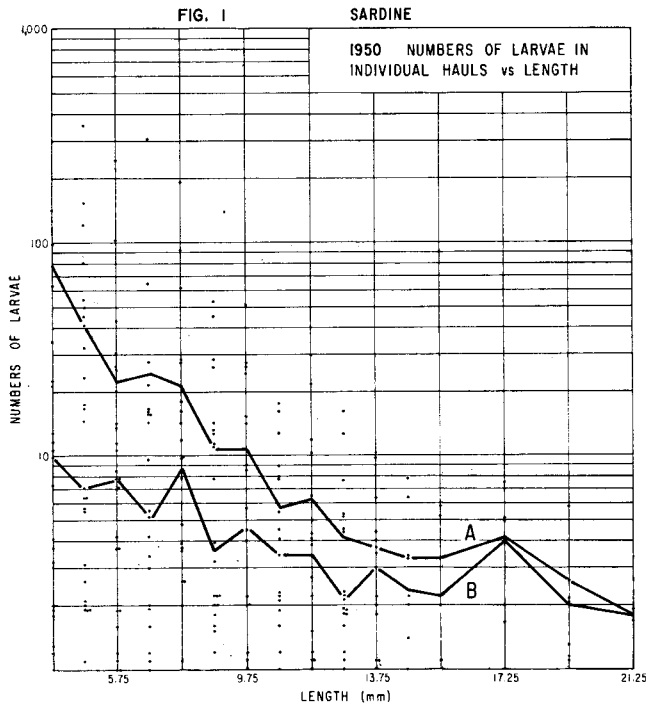

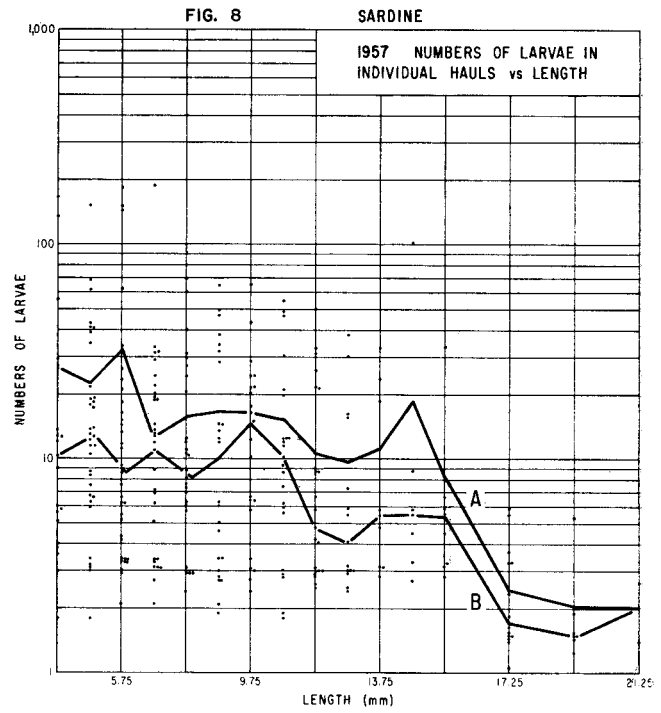
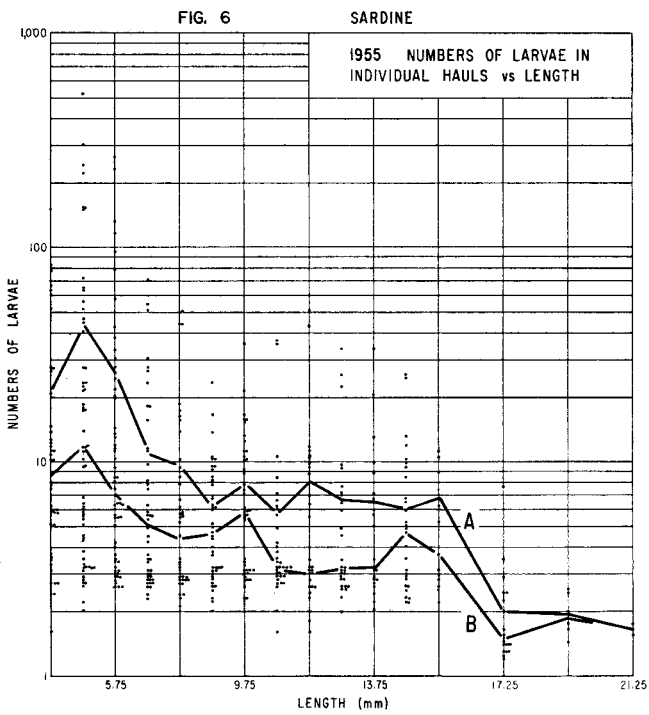
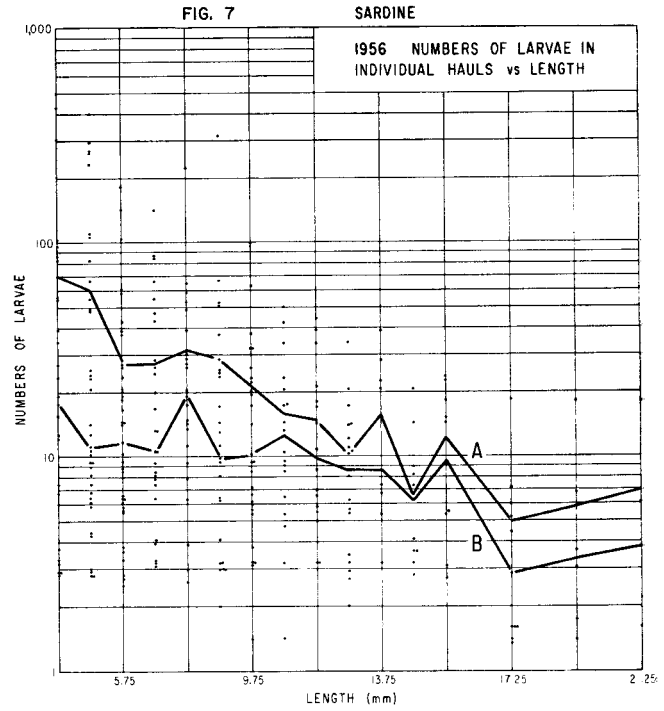
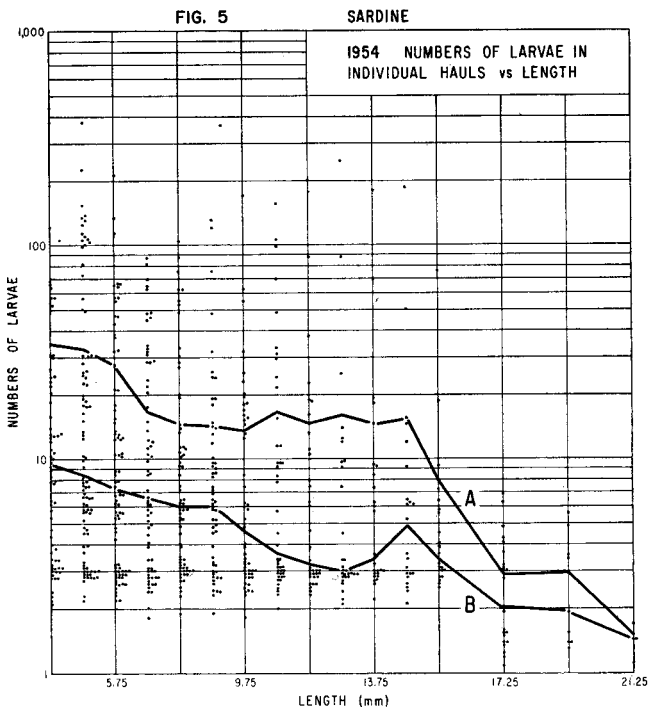

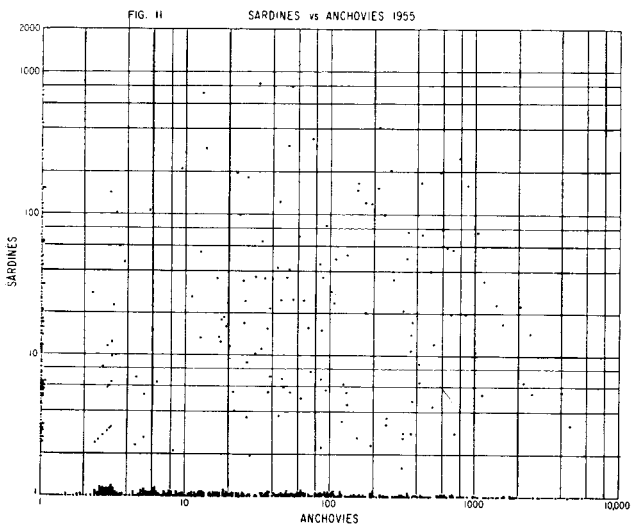
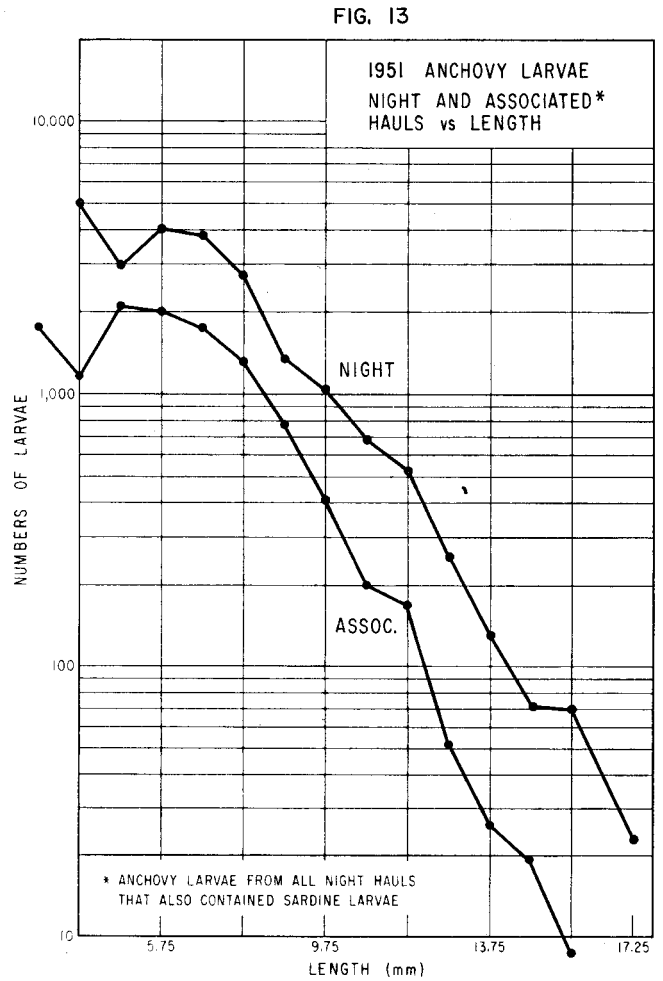
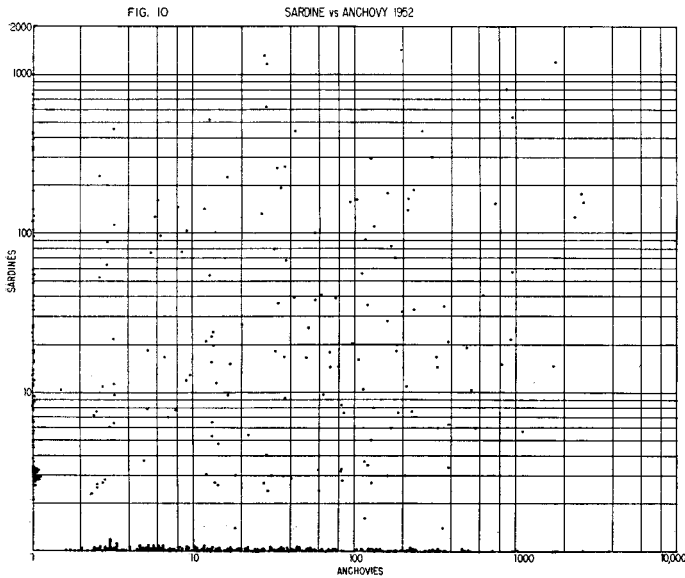
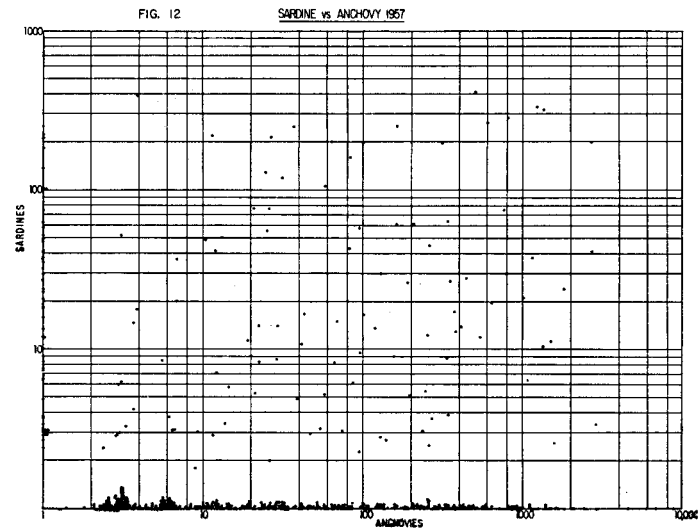
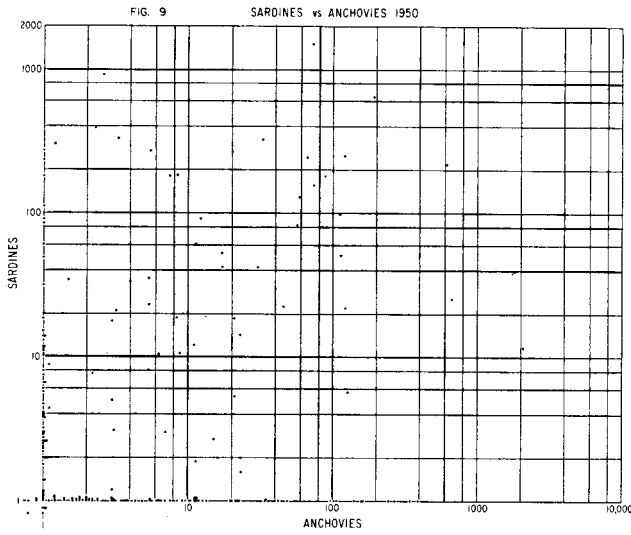

FIG. 14

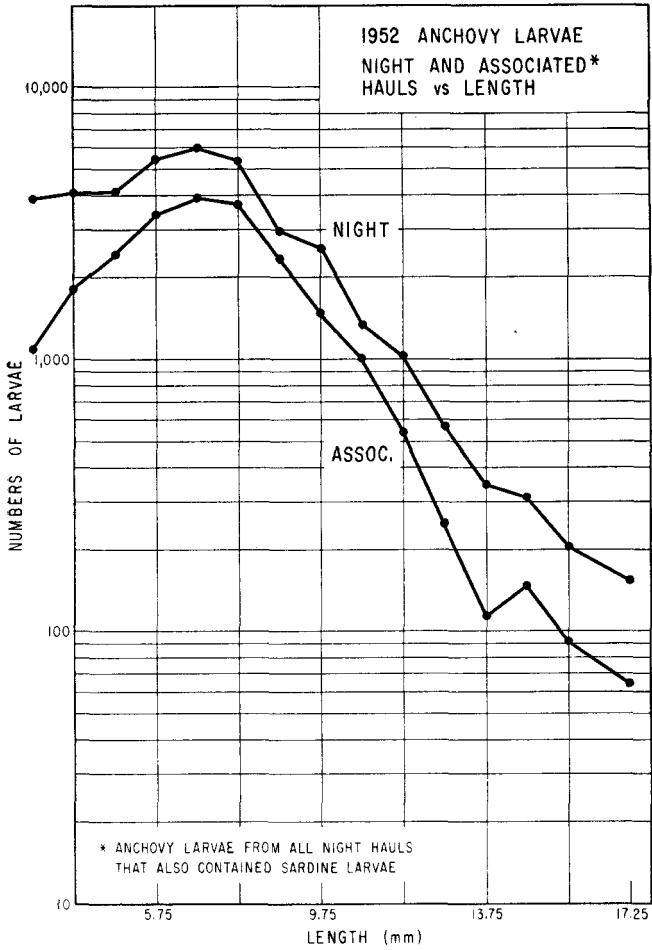

FIG. 15

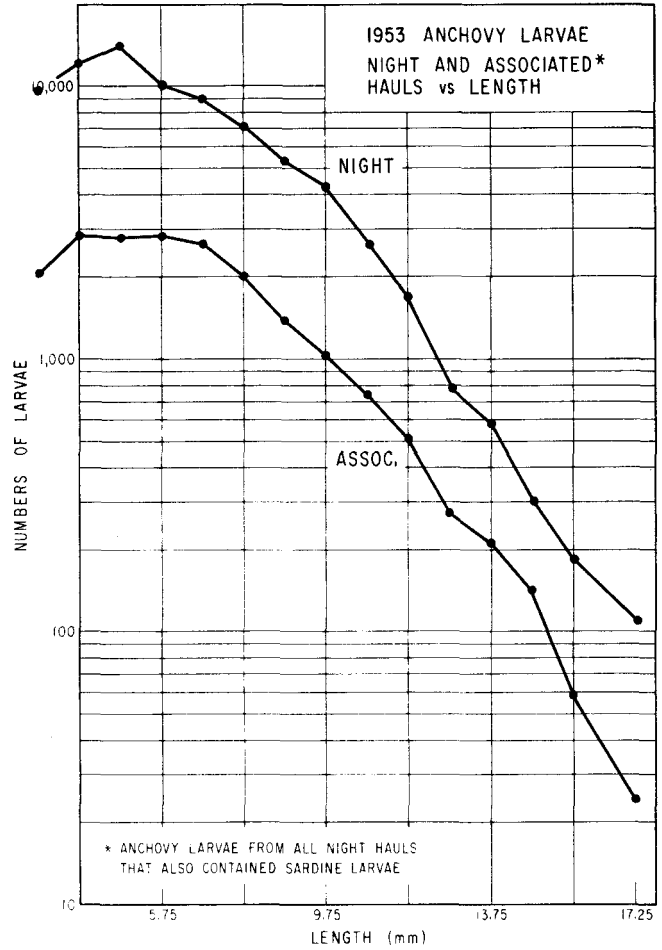

FIG. 16

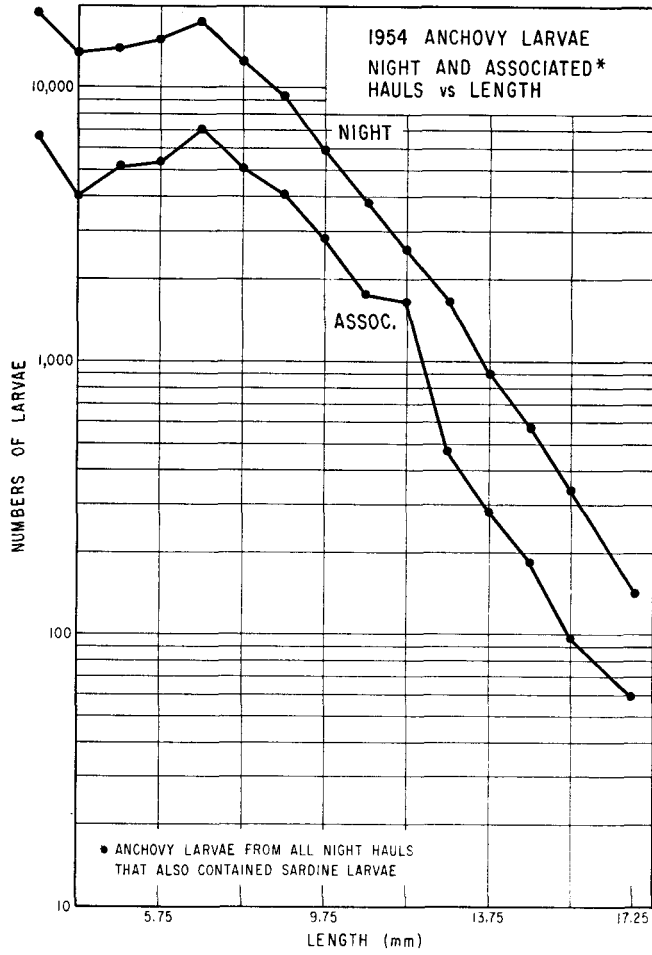

FIG. 17

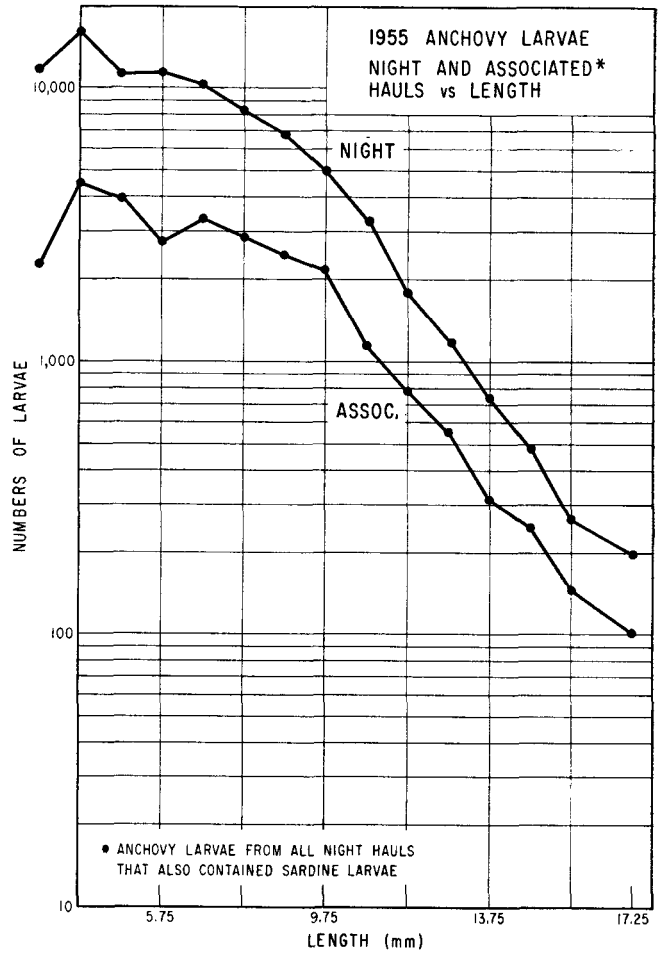

FIG. 18

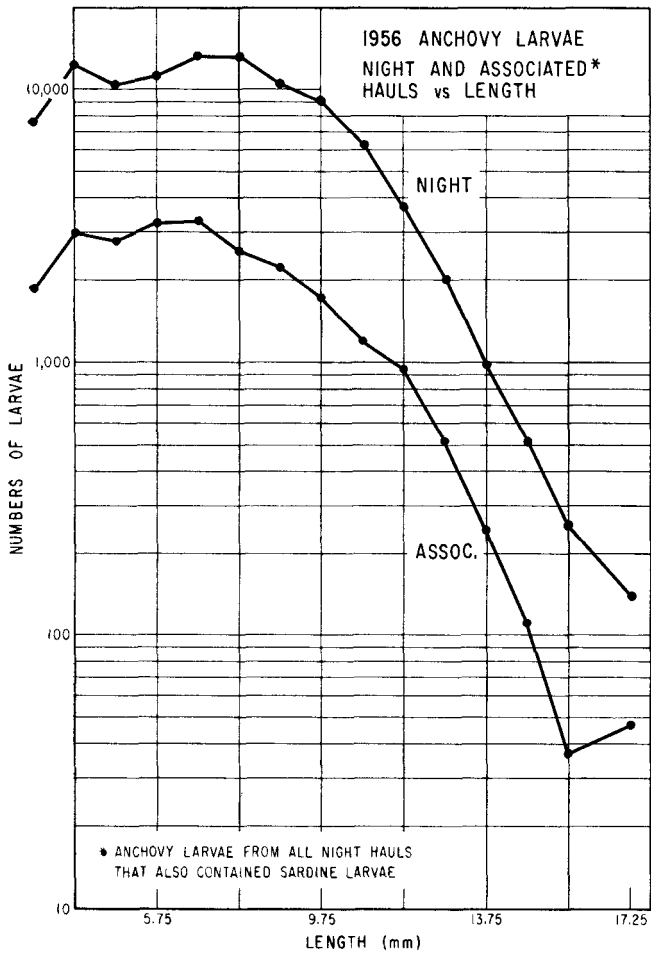

FIG. 19

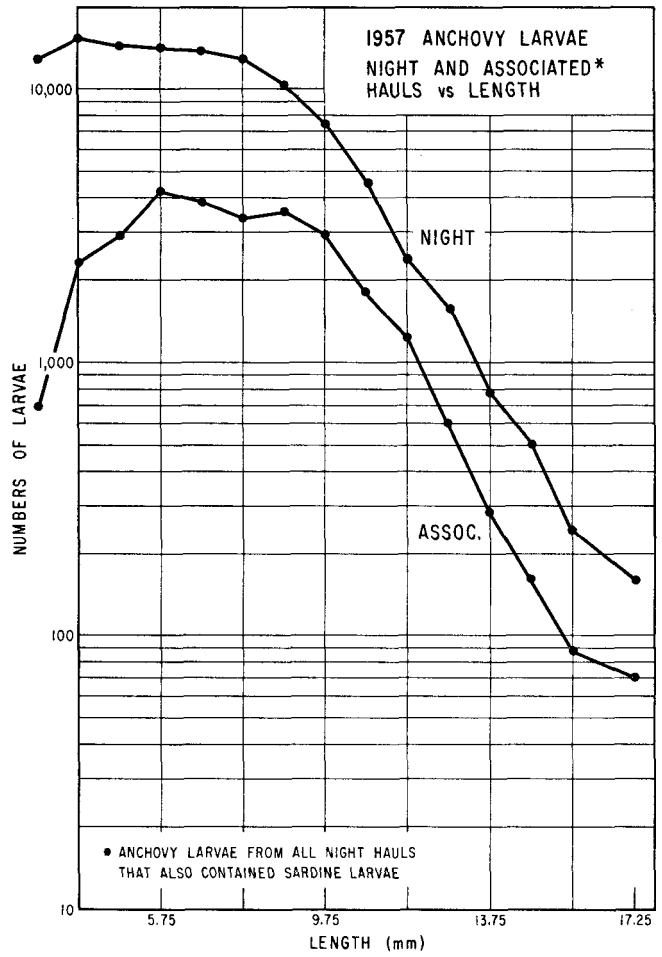

FIG. 20

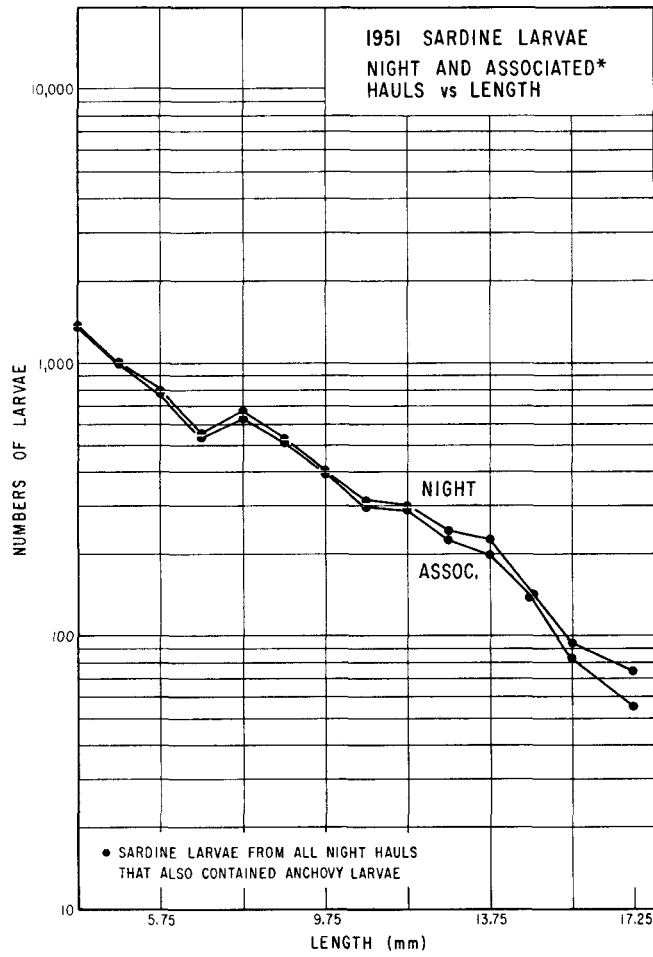

FIG. 21

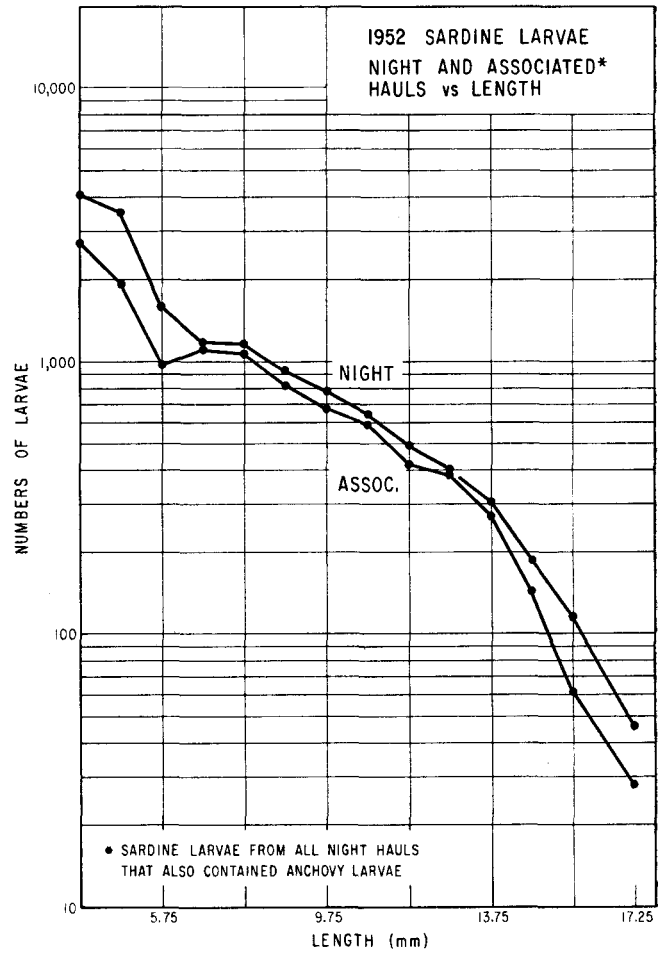



FIG. 22

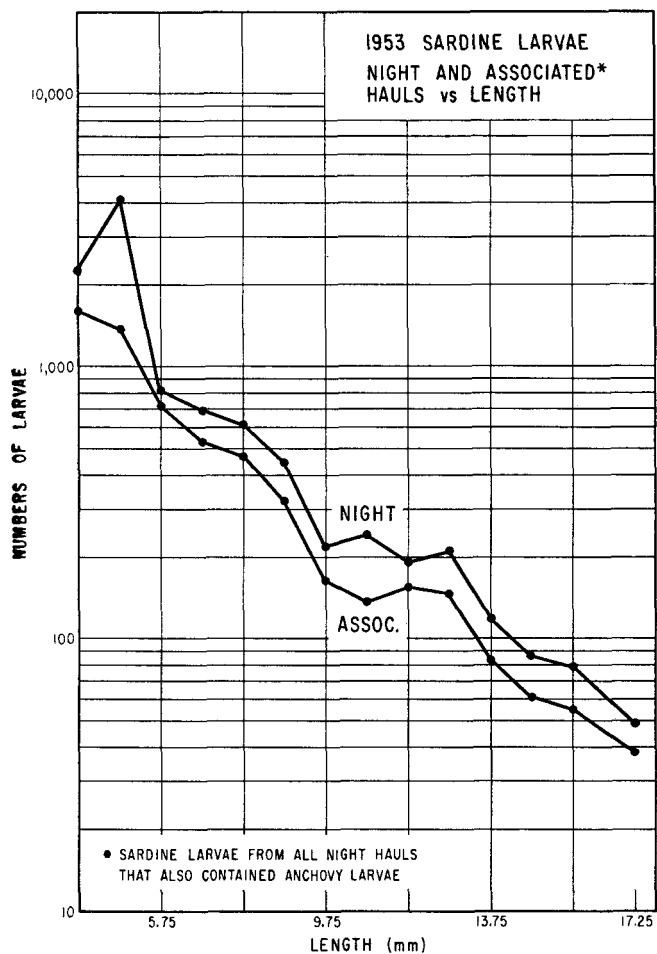

FIG. 23

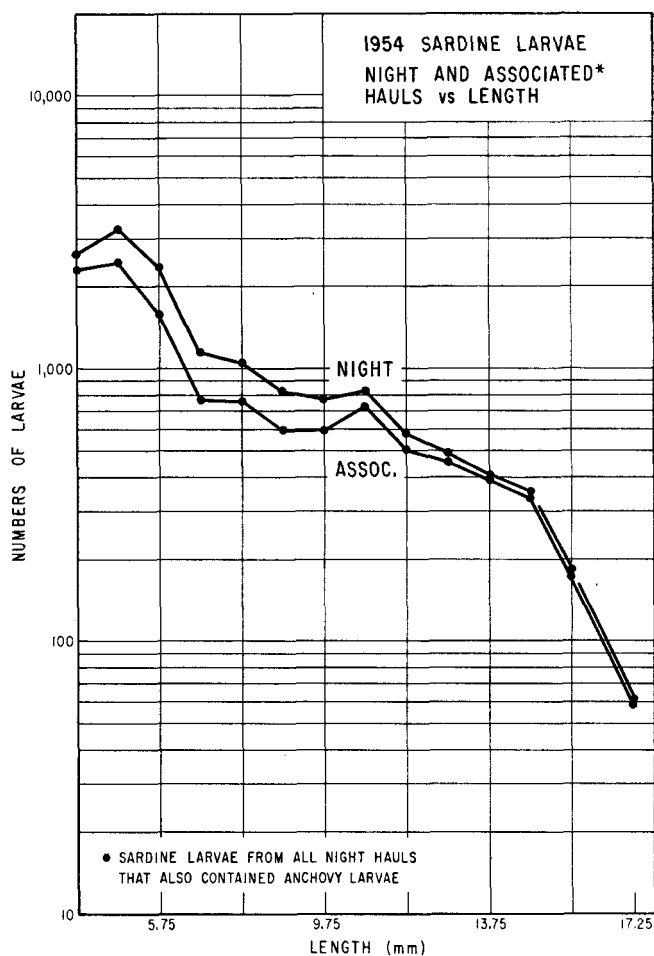

FIG. 24

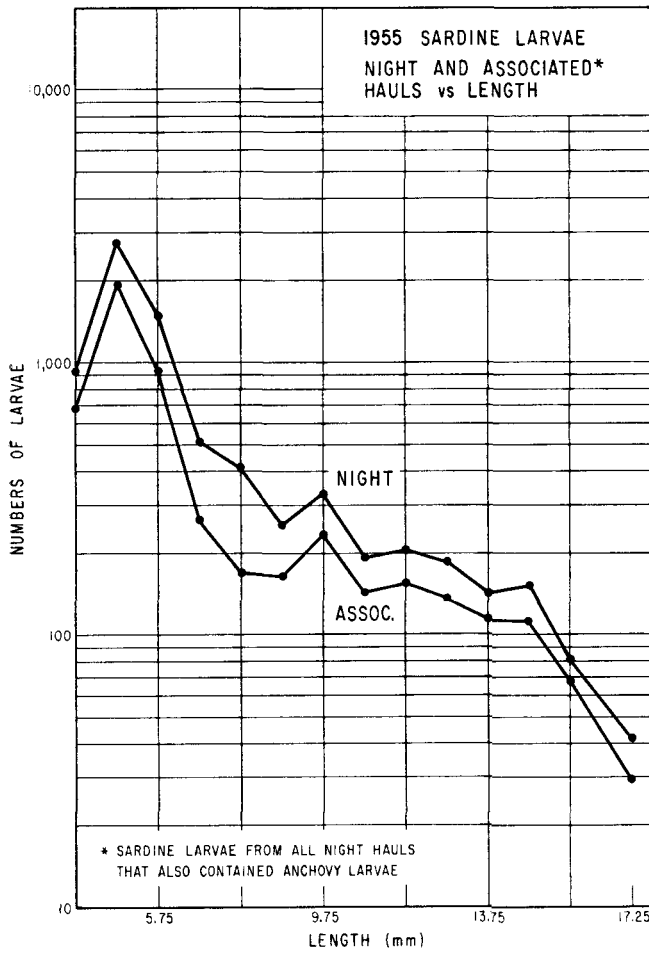

FIG. 25

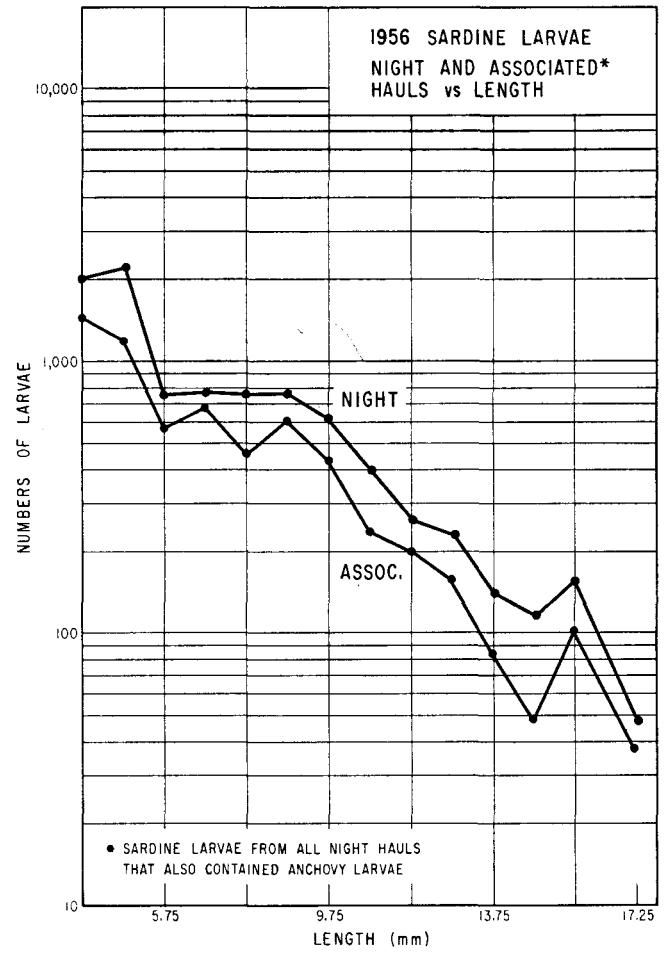
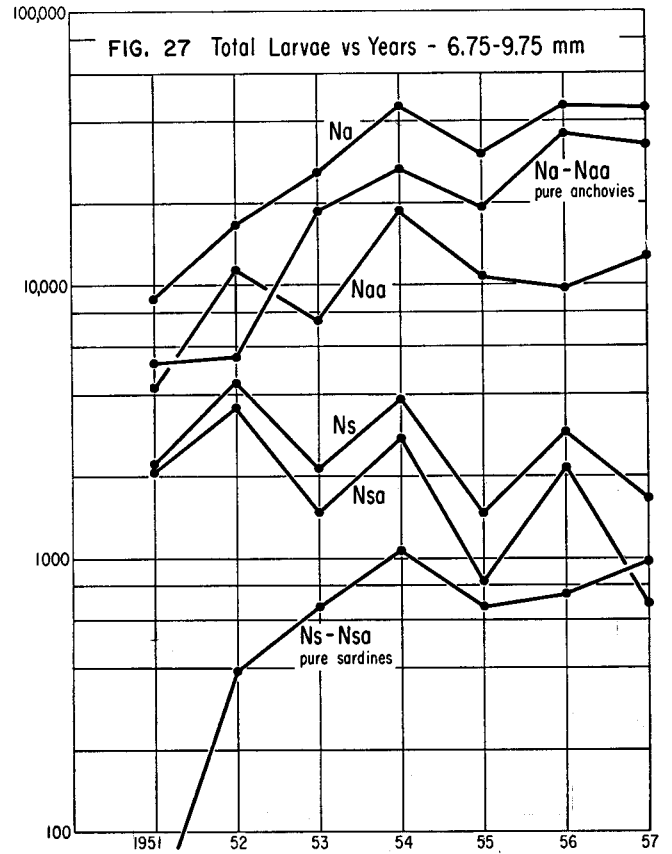
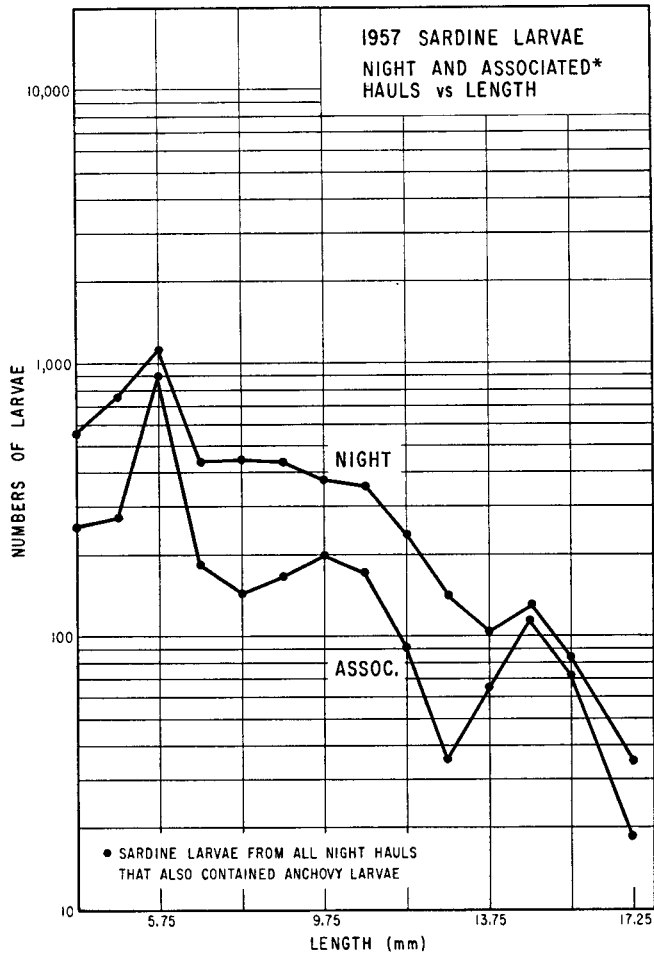

FIG. 26



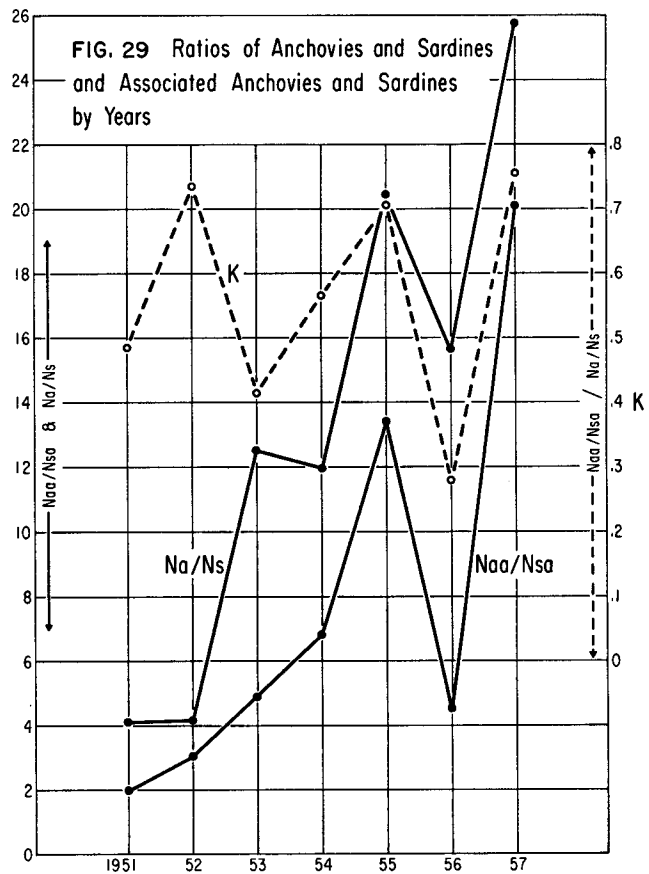
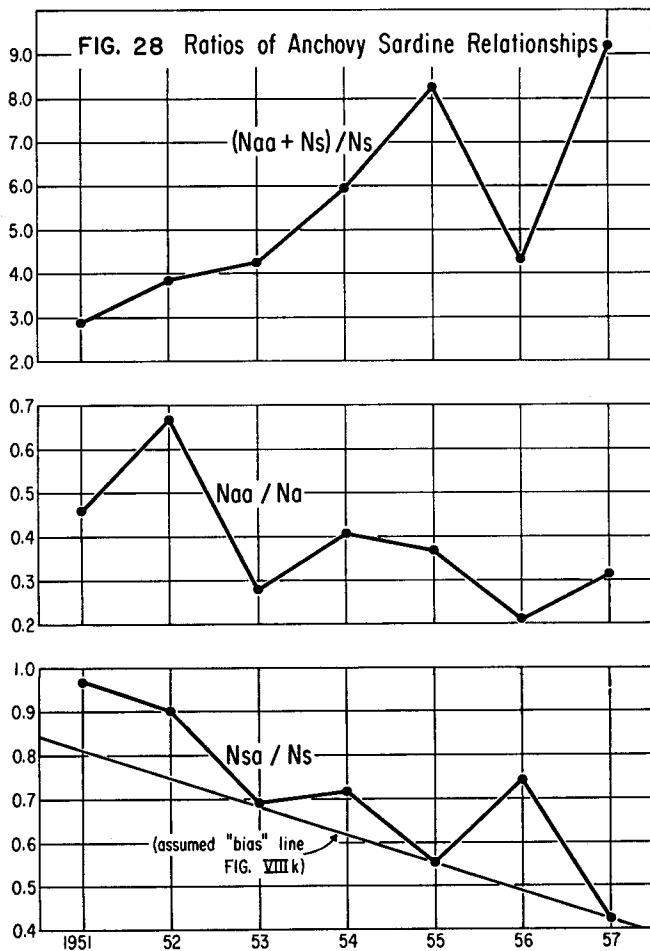

FIG. 30

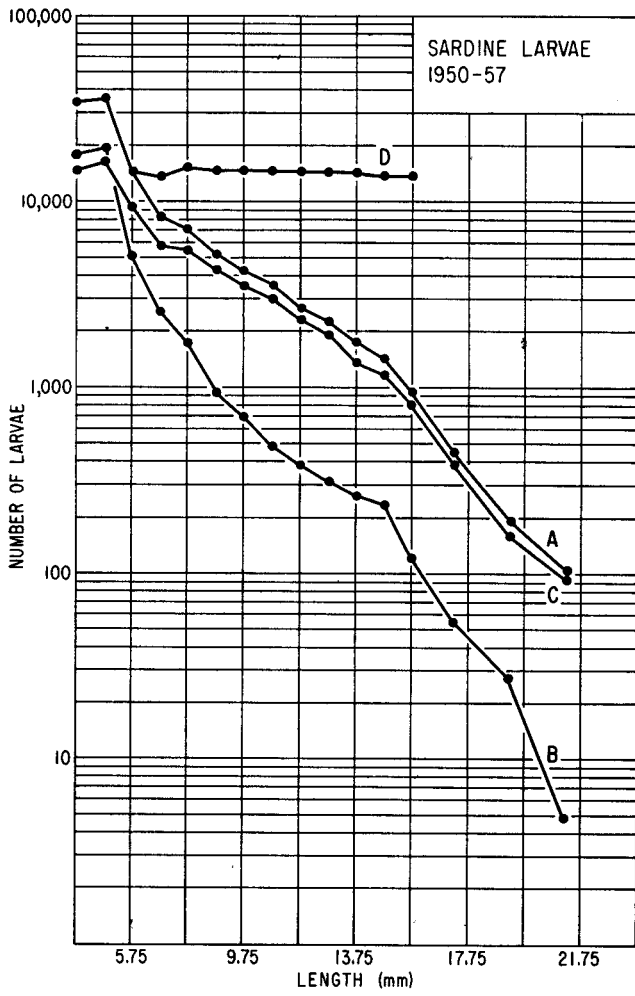

FIG. 31

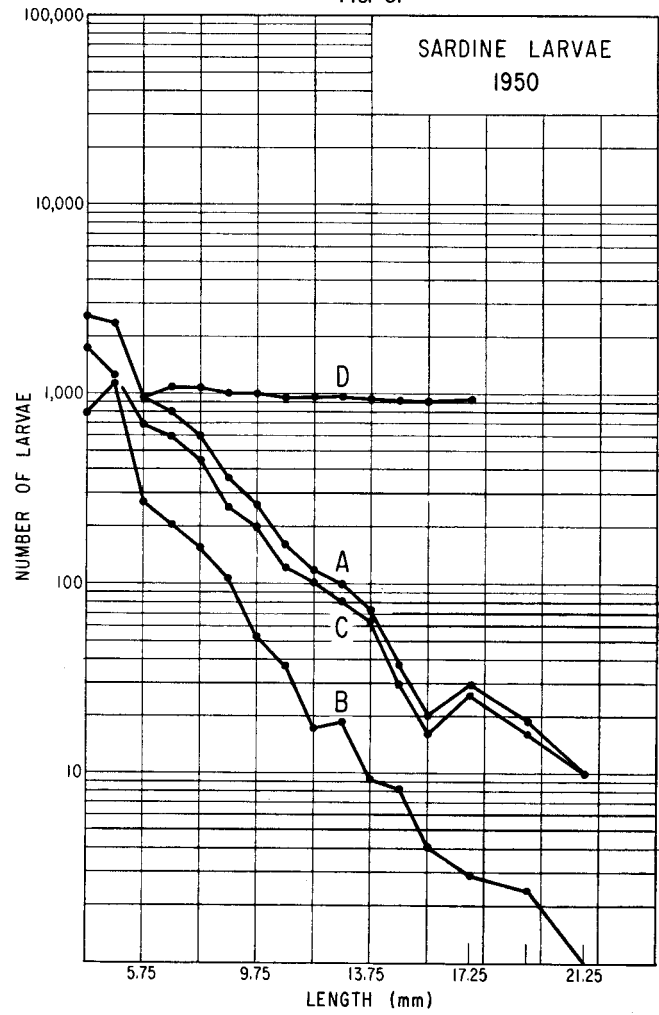

FIG. 32

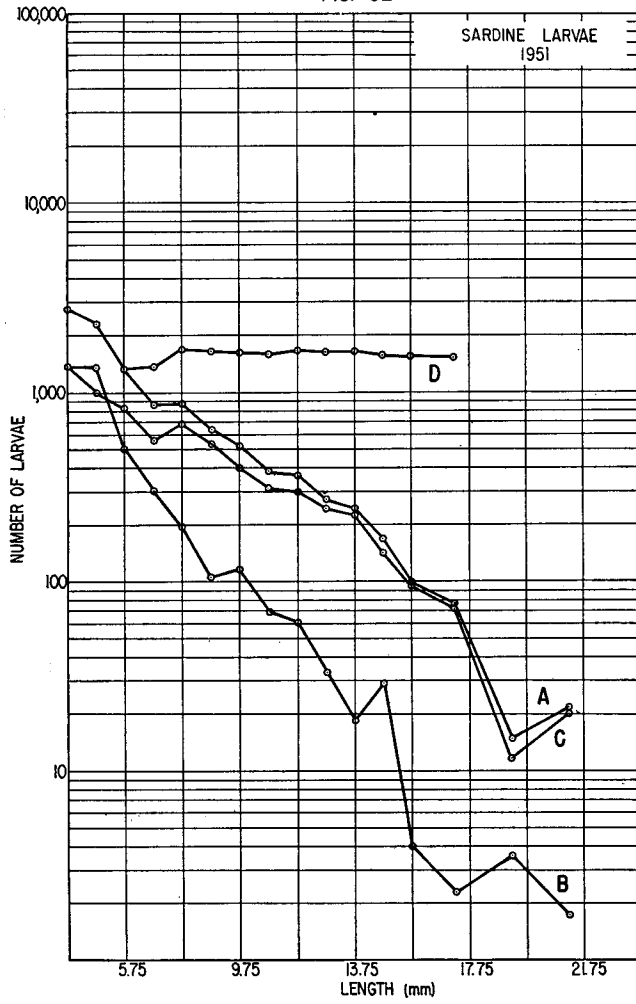

FIG. 33

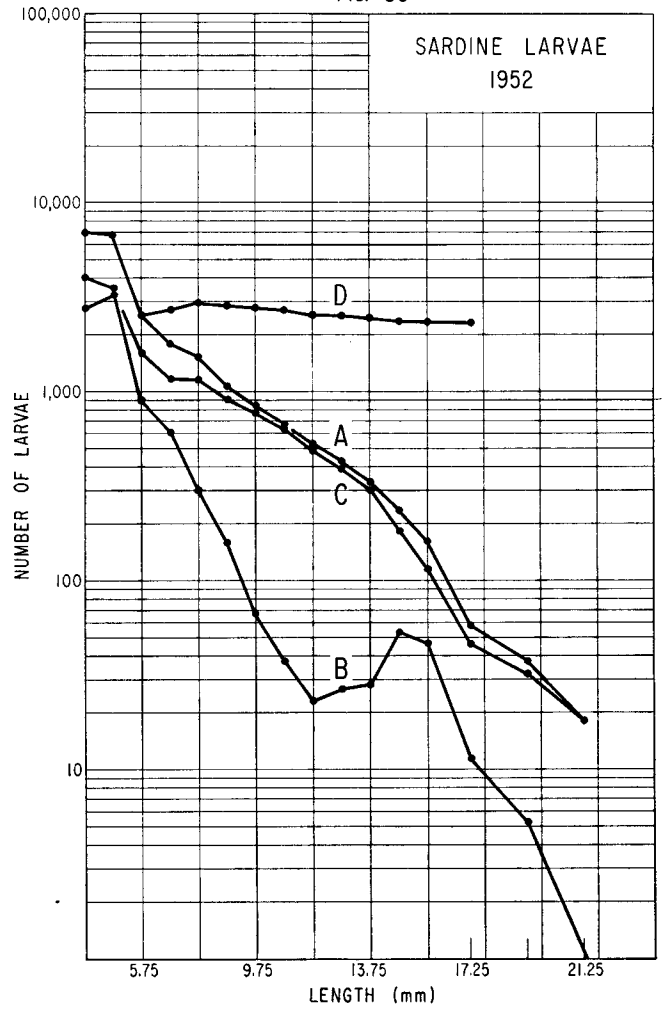

FIG. 34

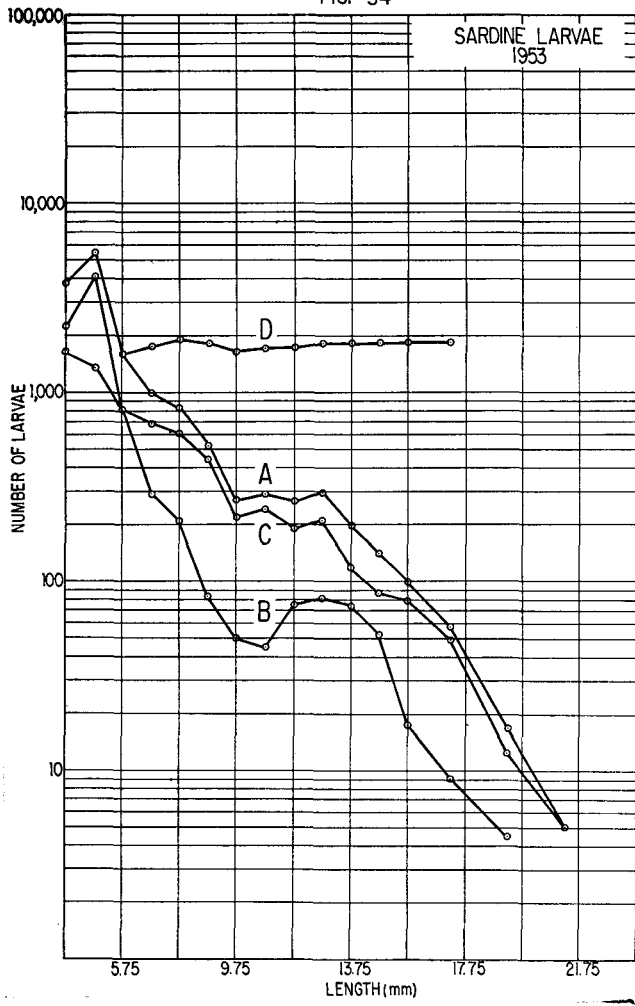

FIG. 35

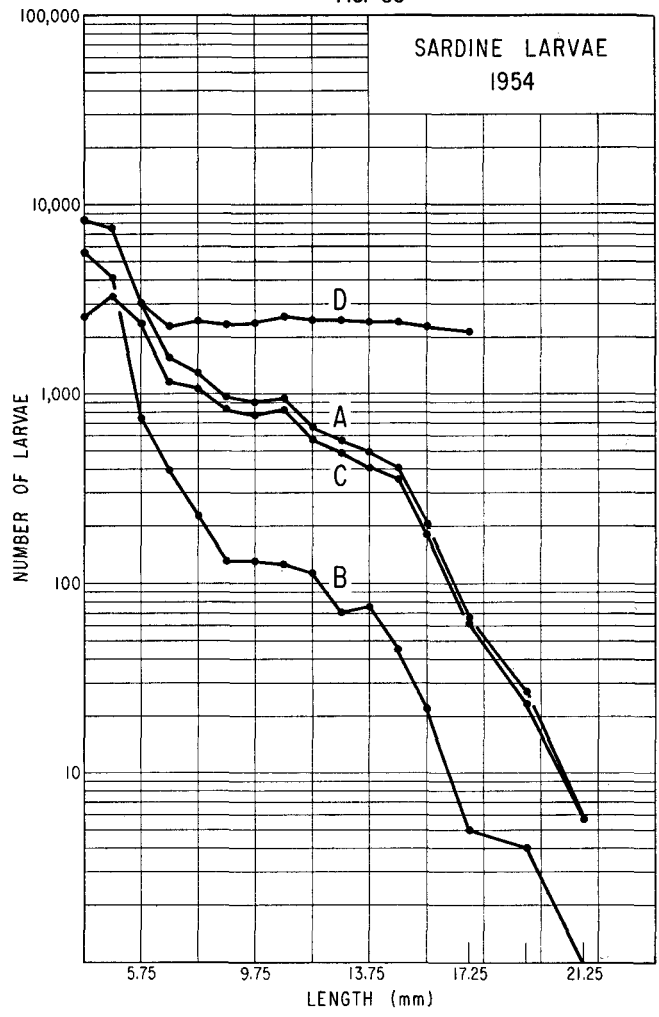

FIG. 36

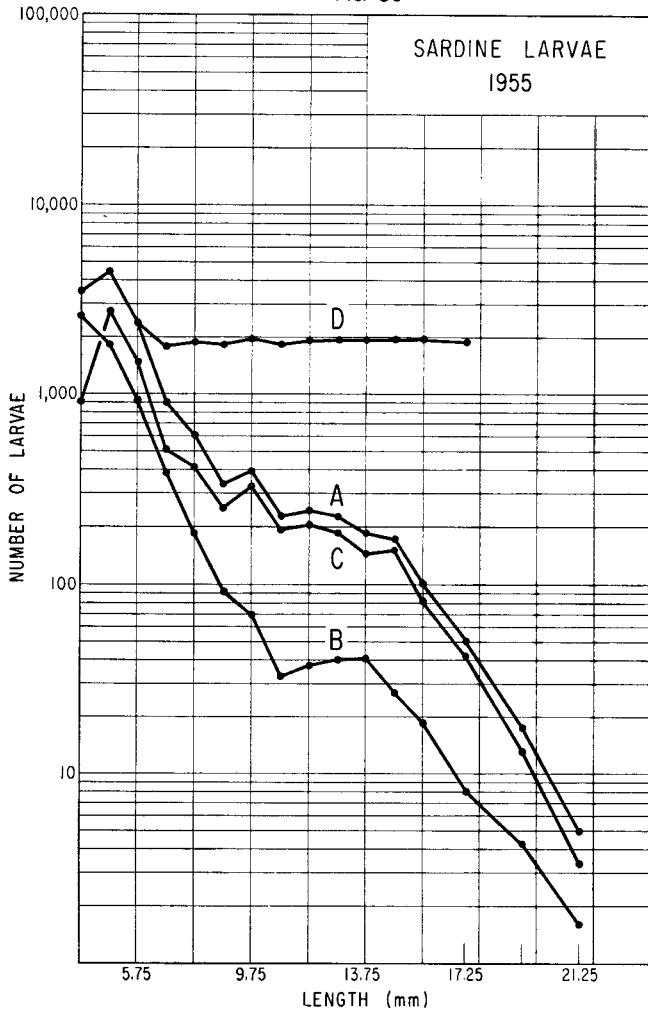

FIG. 37

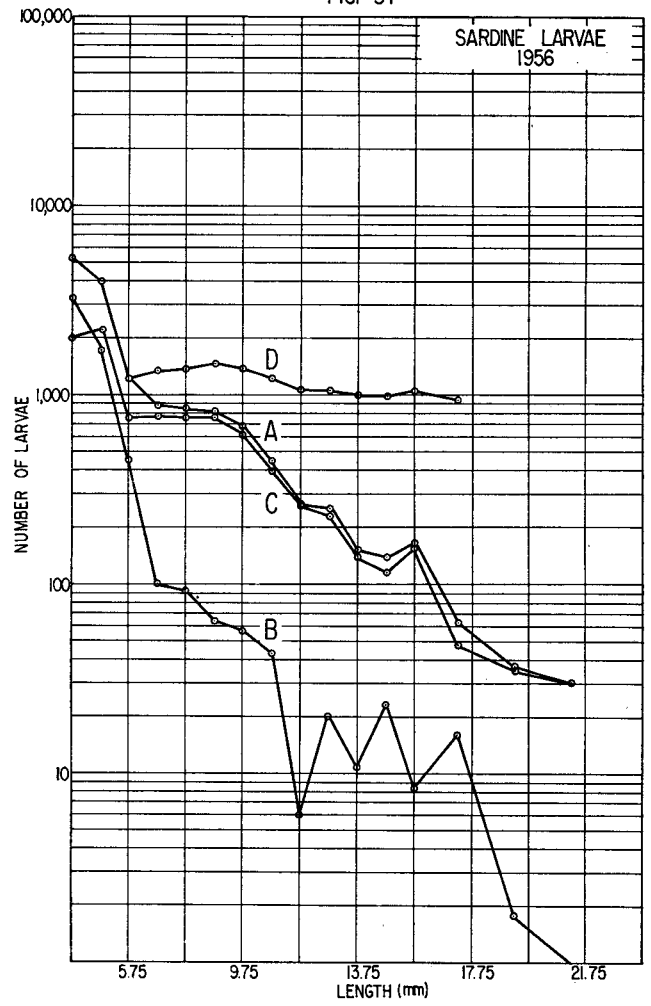



FIG. 38

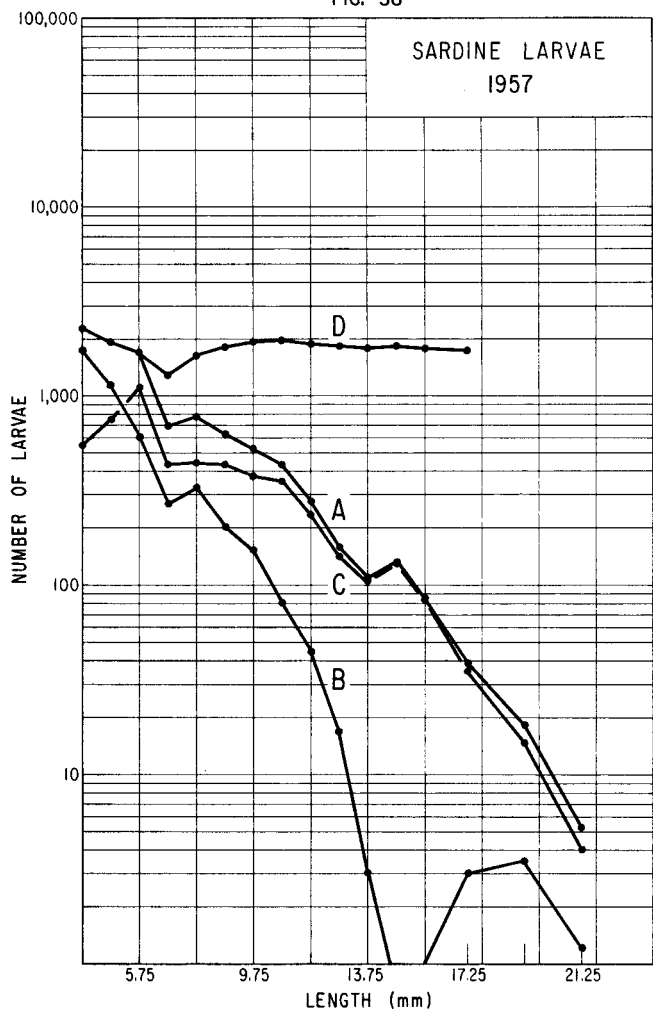
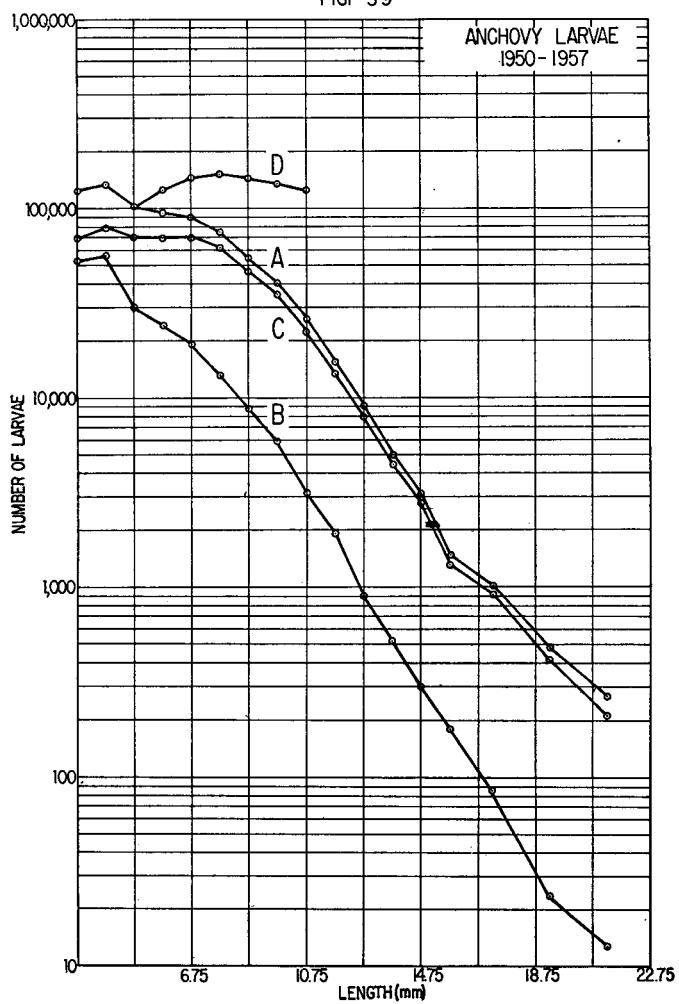

FIG. 39



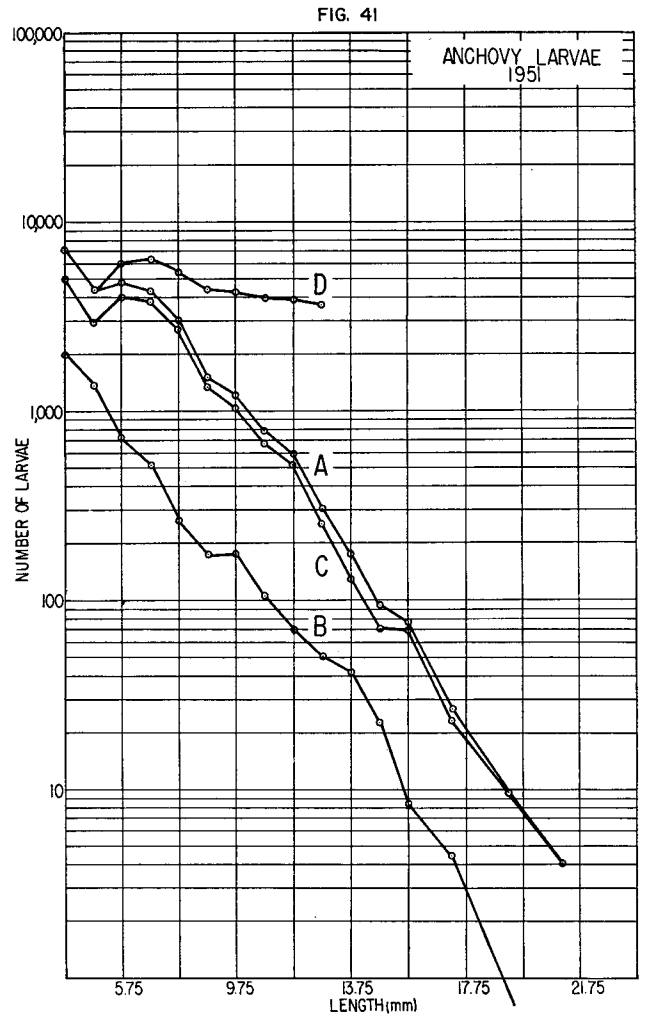
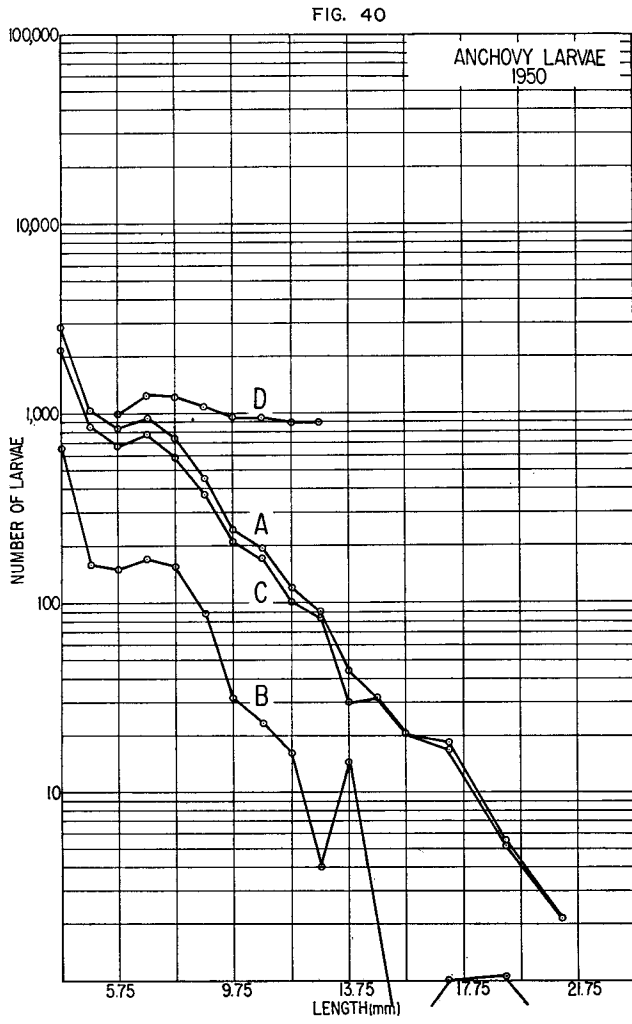

FIG. 42

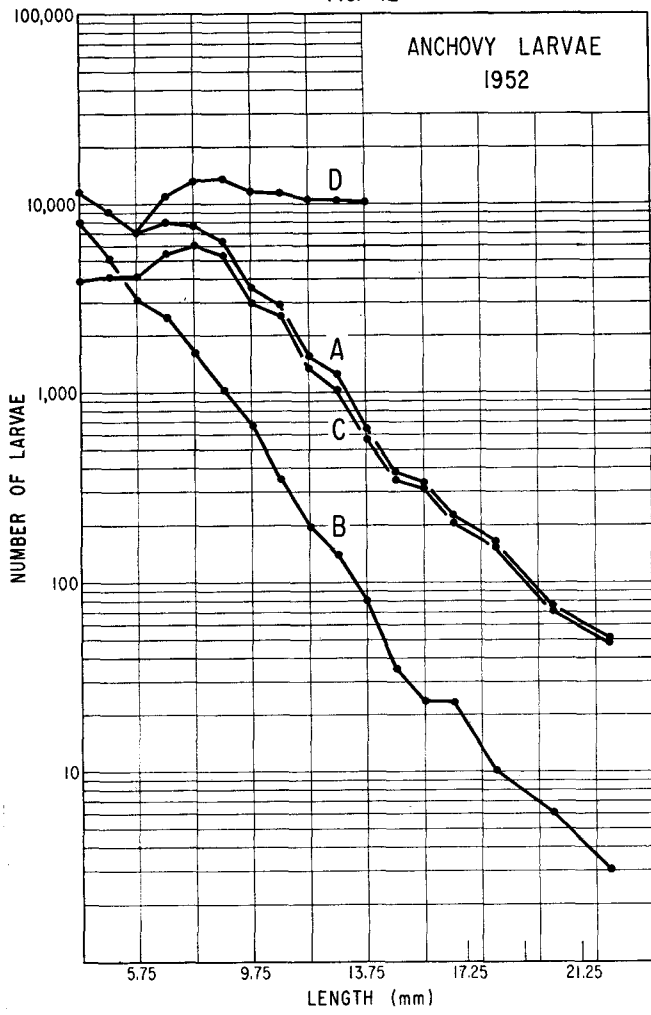
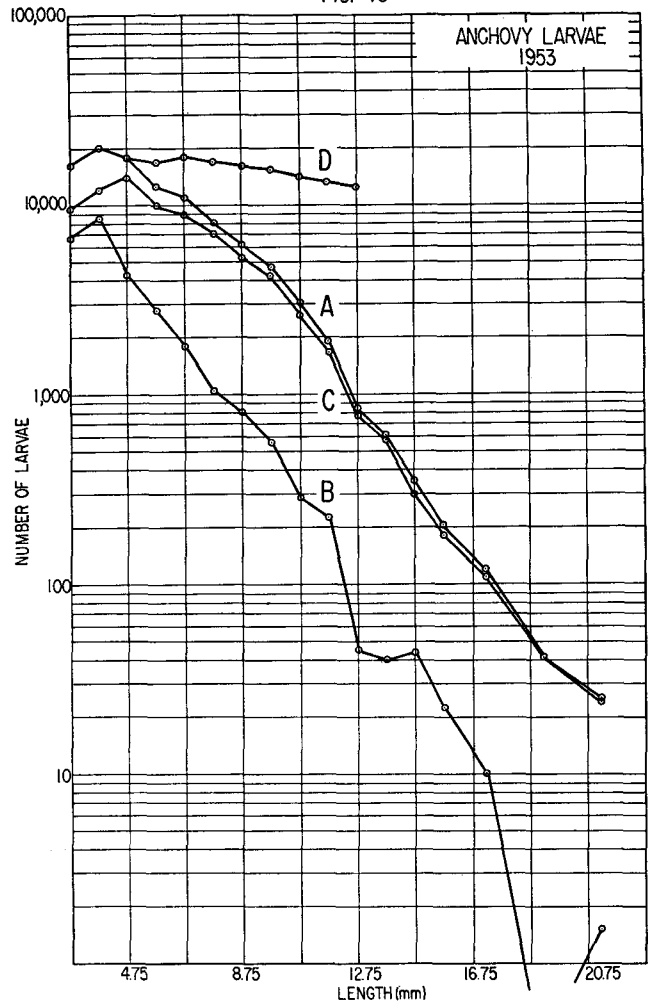

FIG. 43



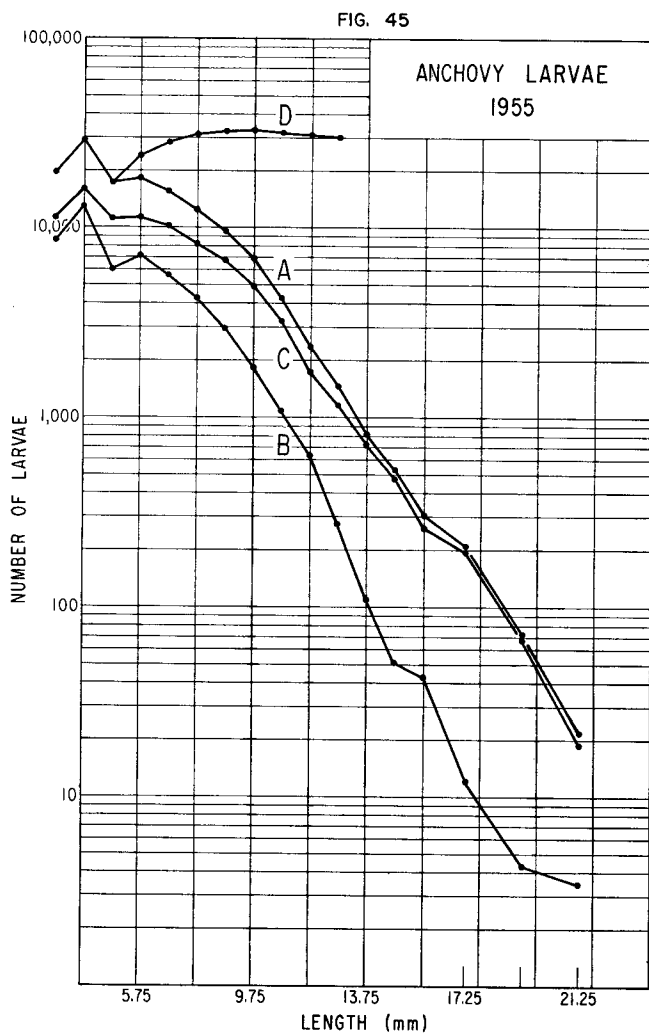
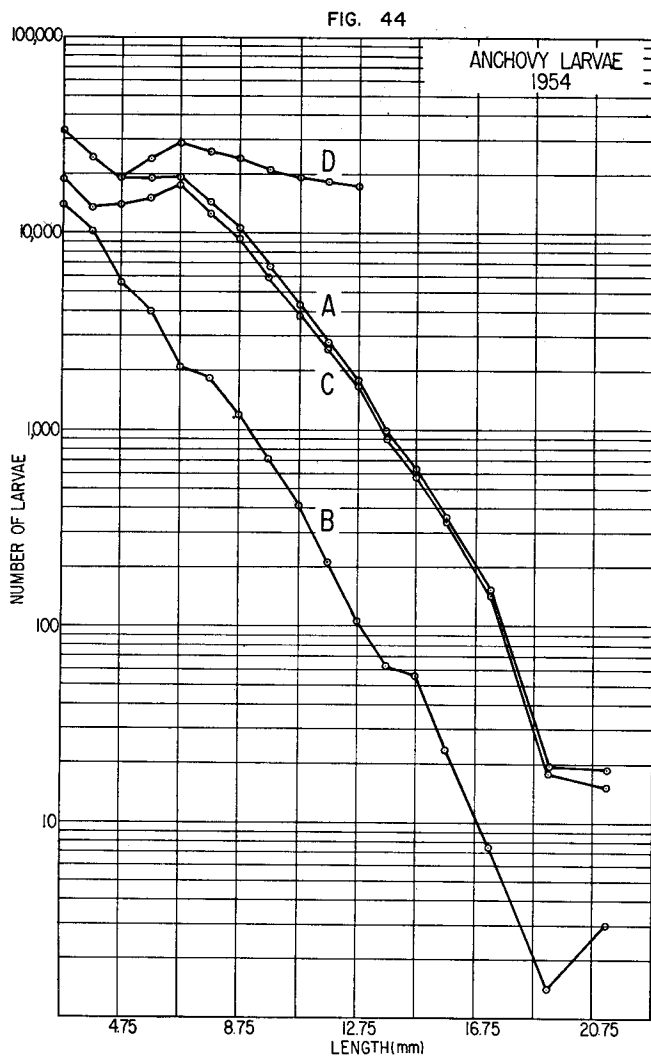

FIG. 46

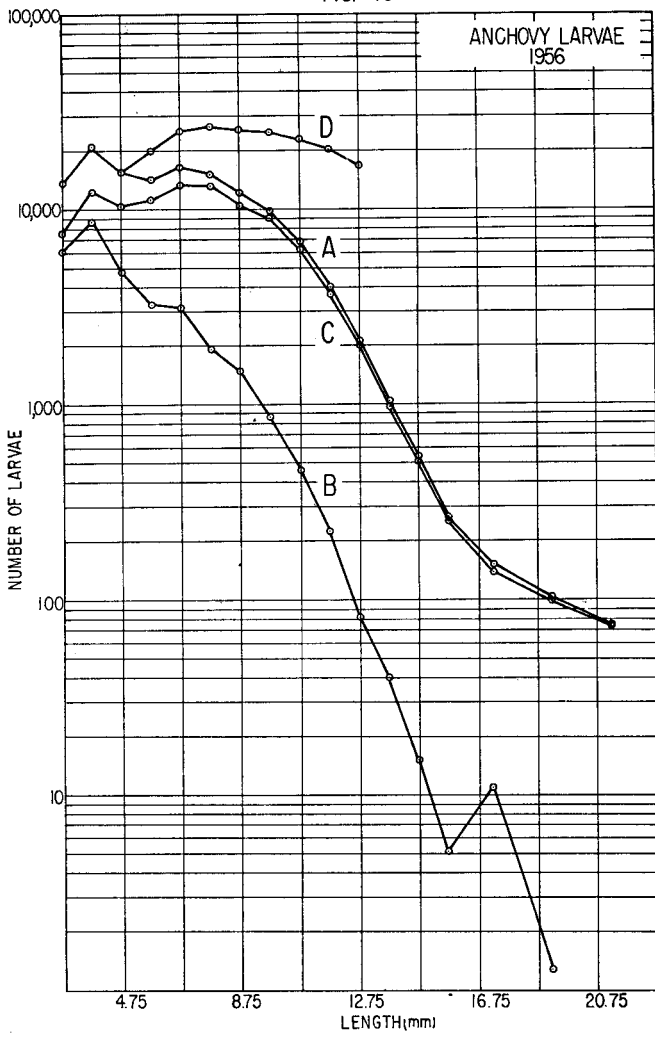
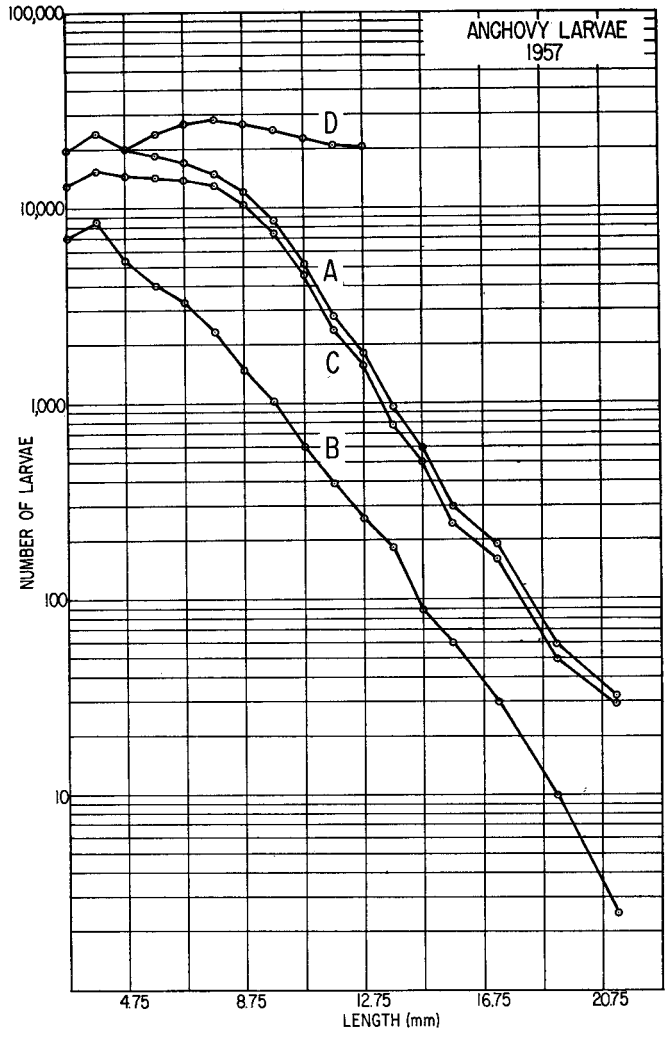

FIG. 47



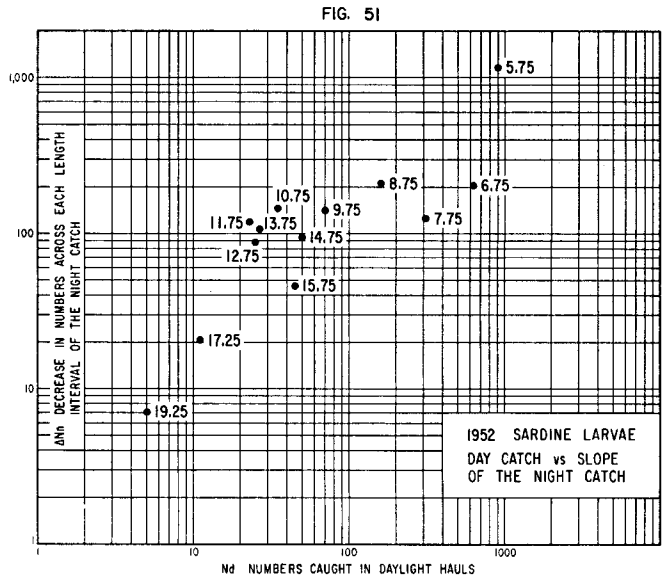
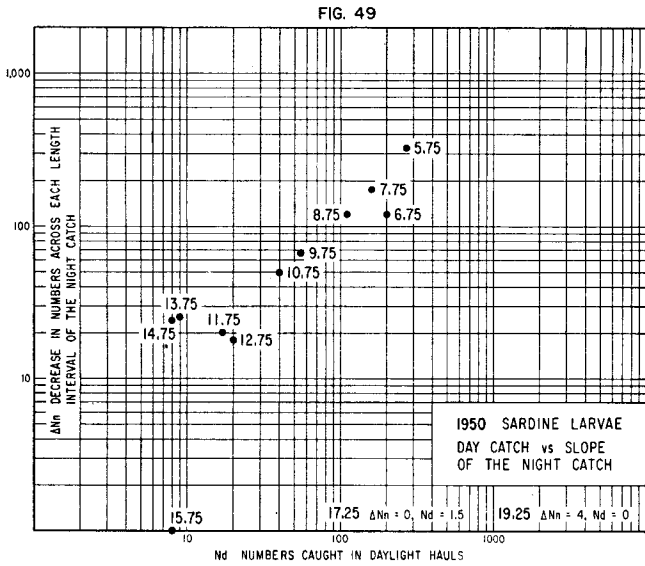
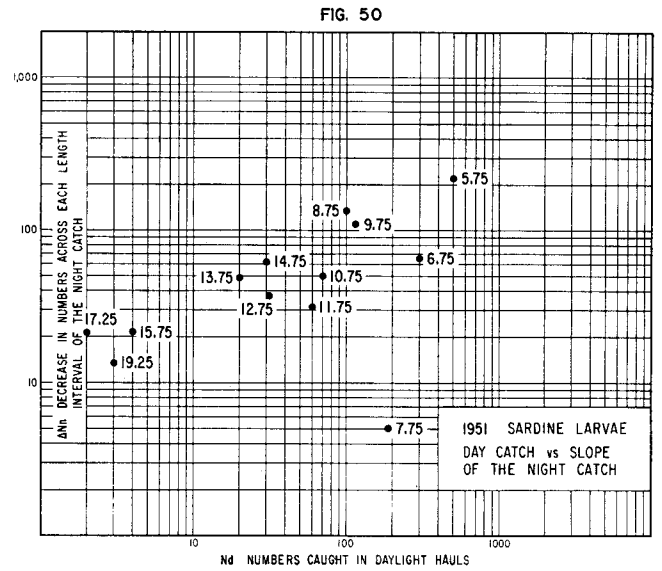
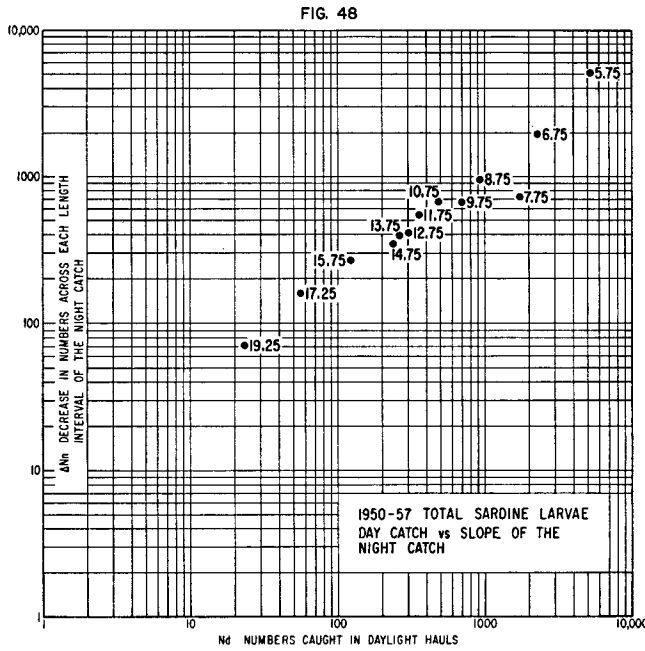

FIG. 52

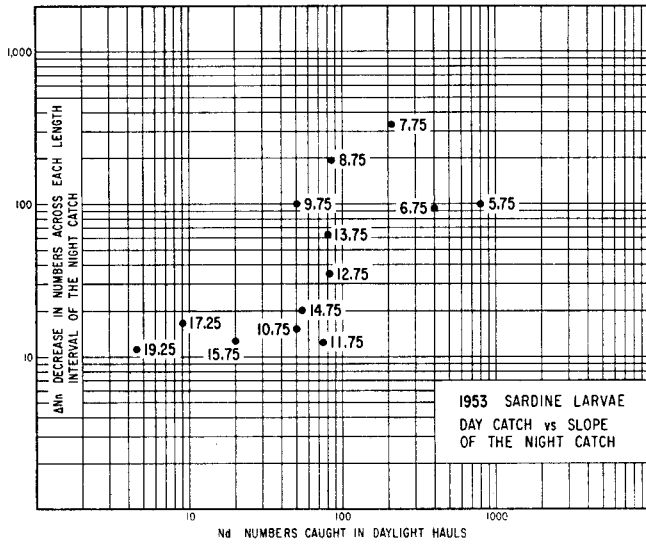

FIG. 54

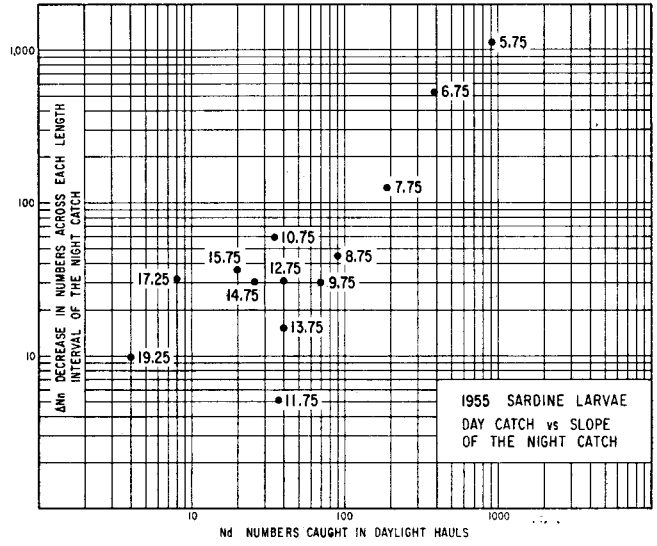

FIG. 53

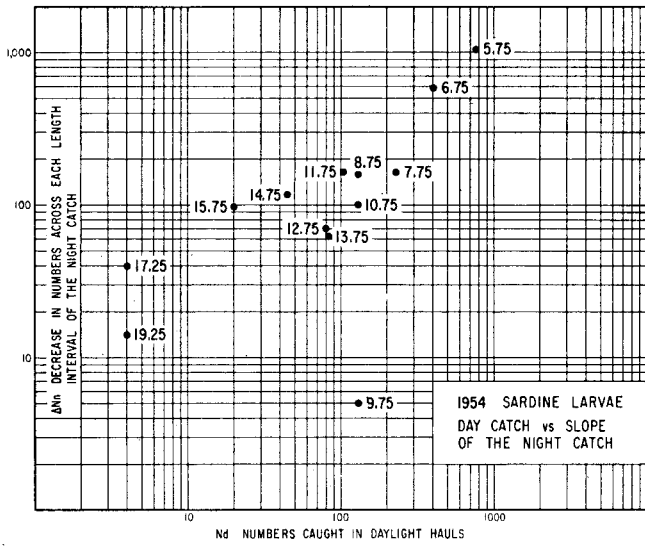

FIG. 55

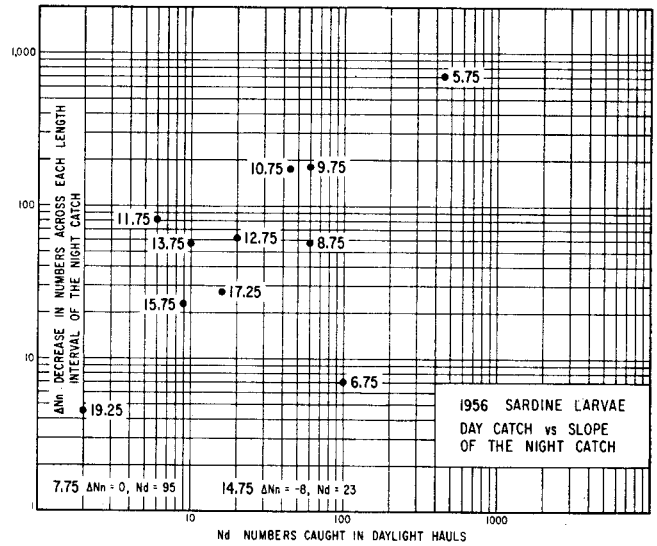
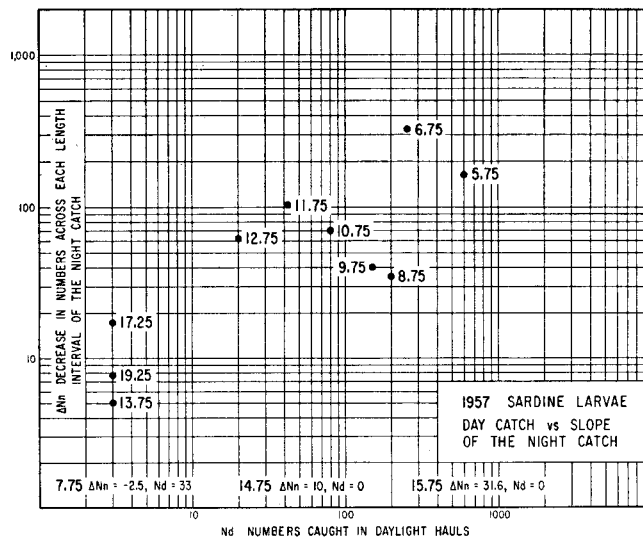
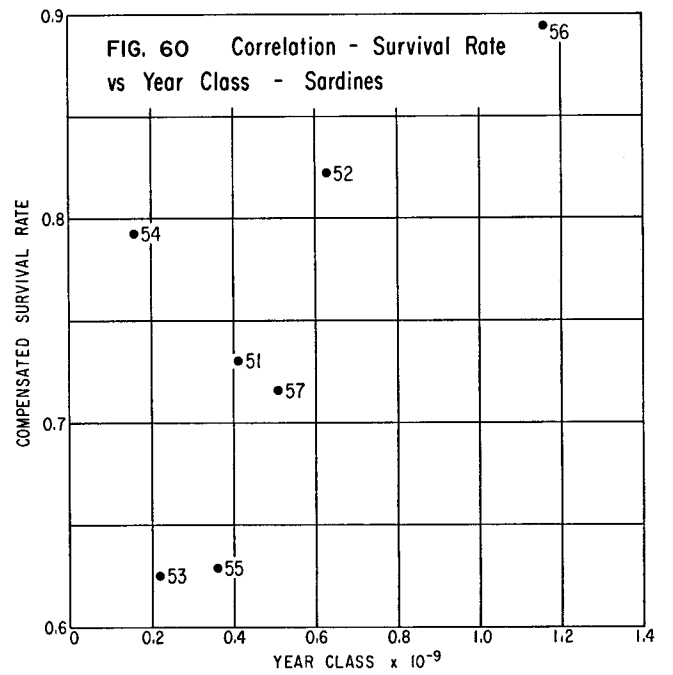
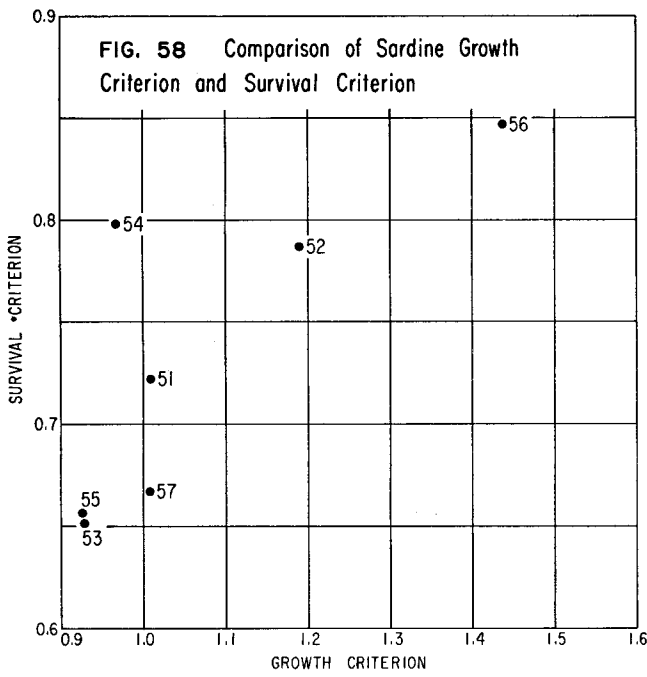
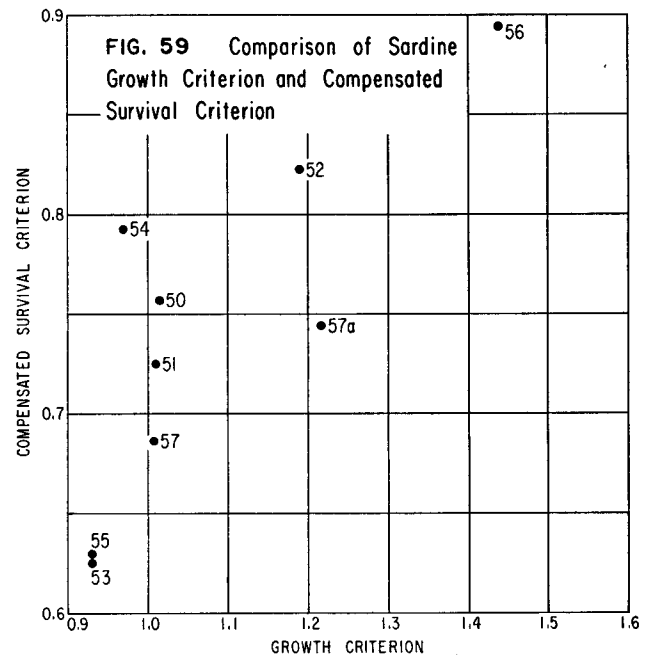
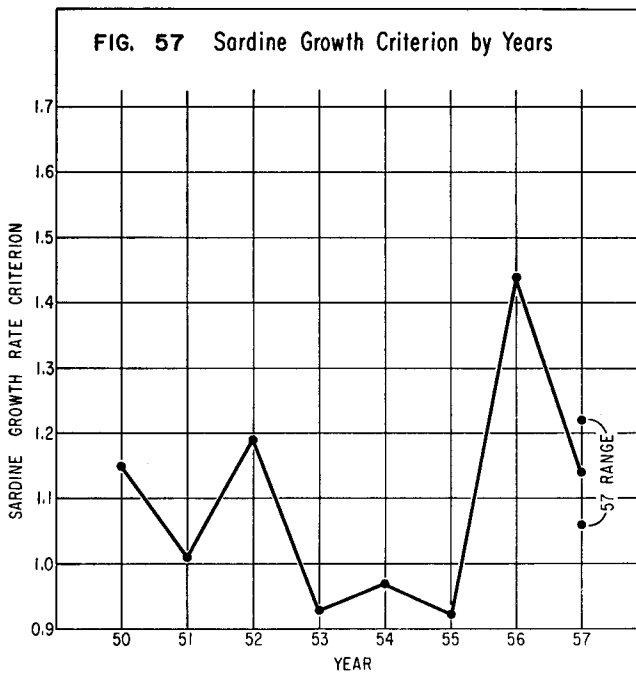
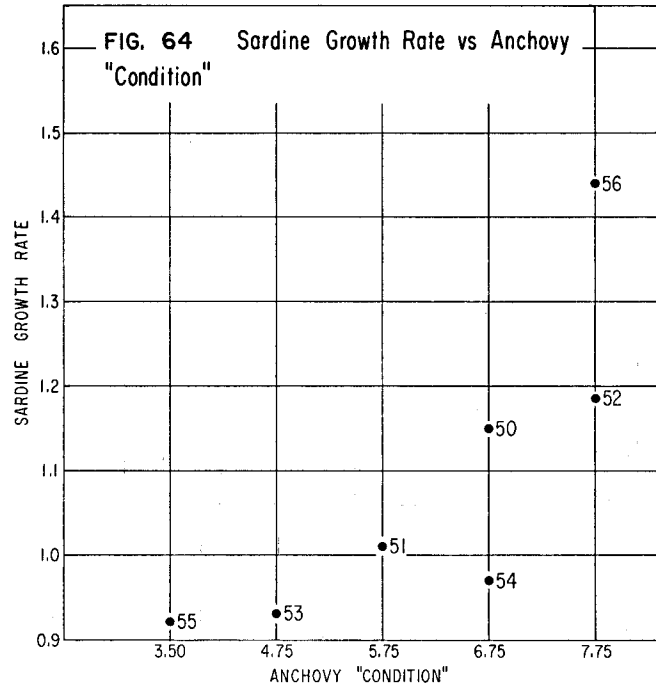
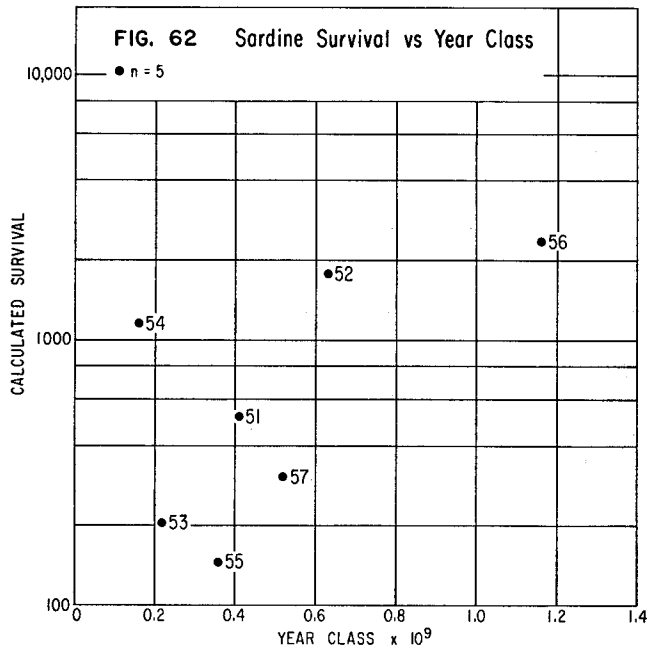
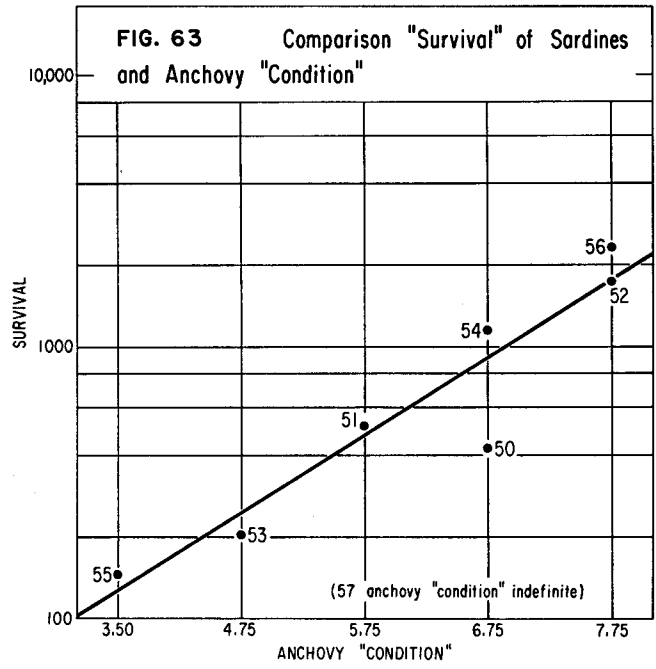
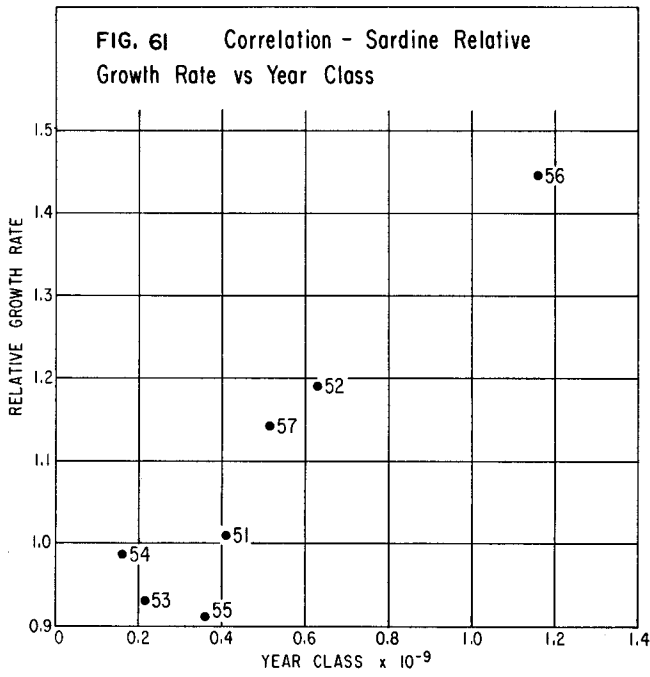

FIG. 56









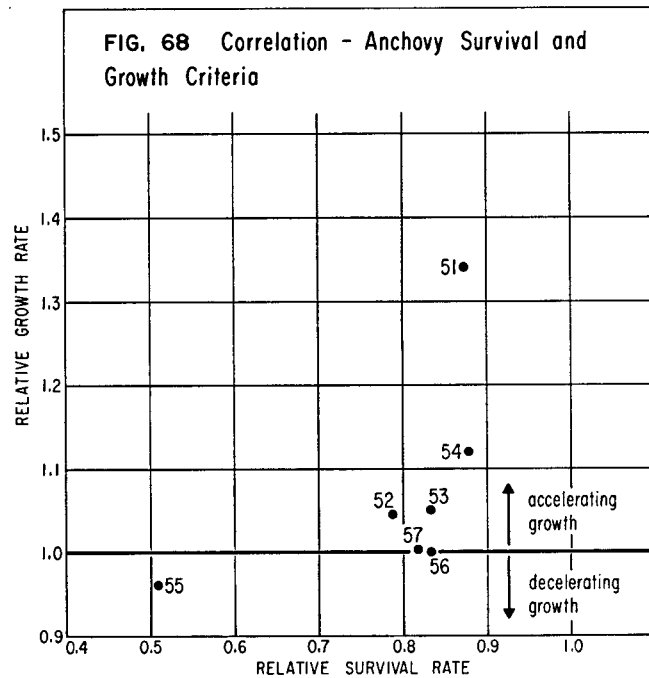
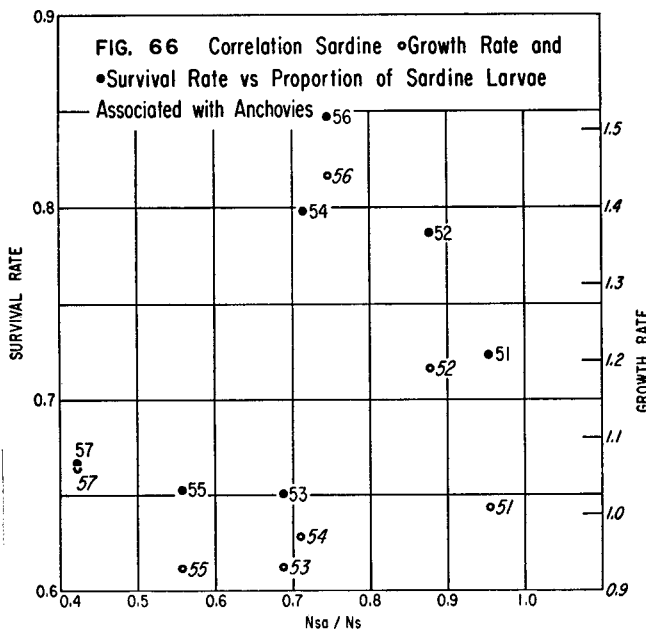
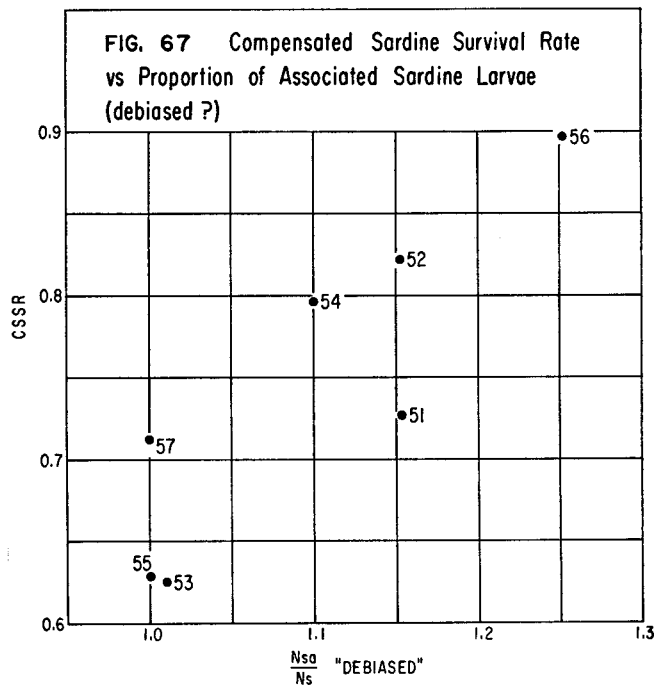
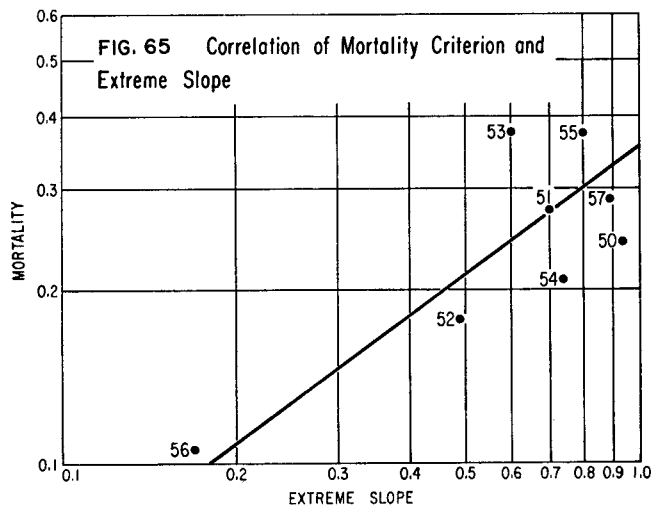

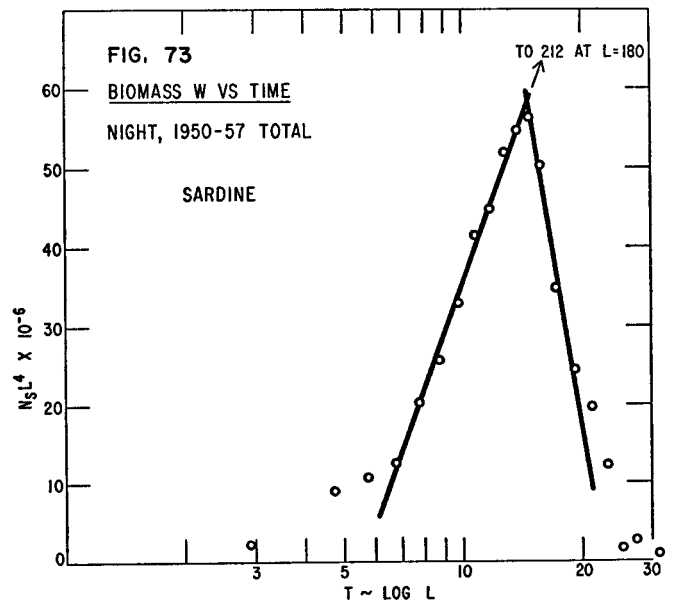
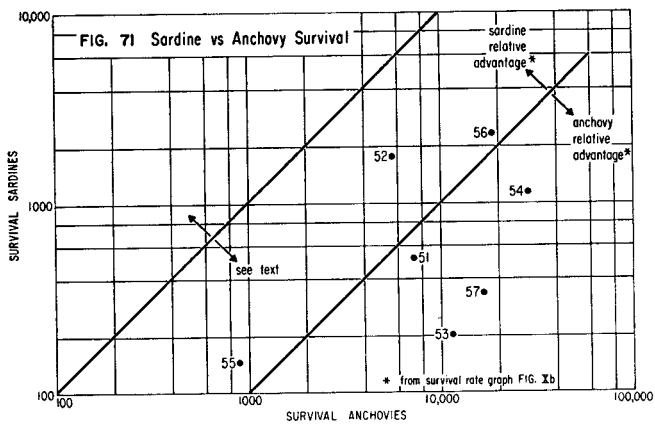
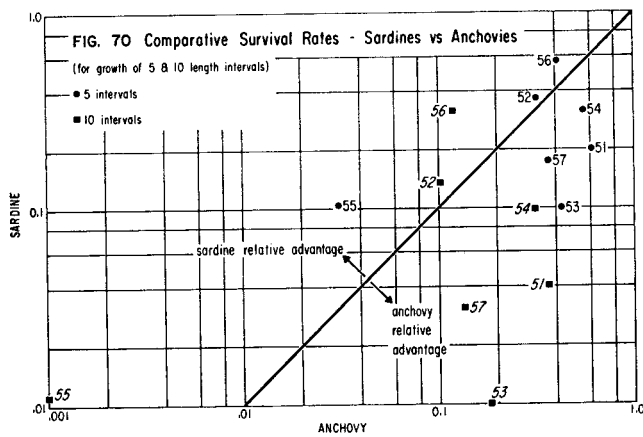
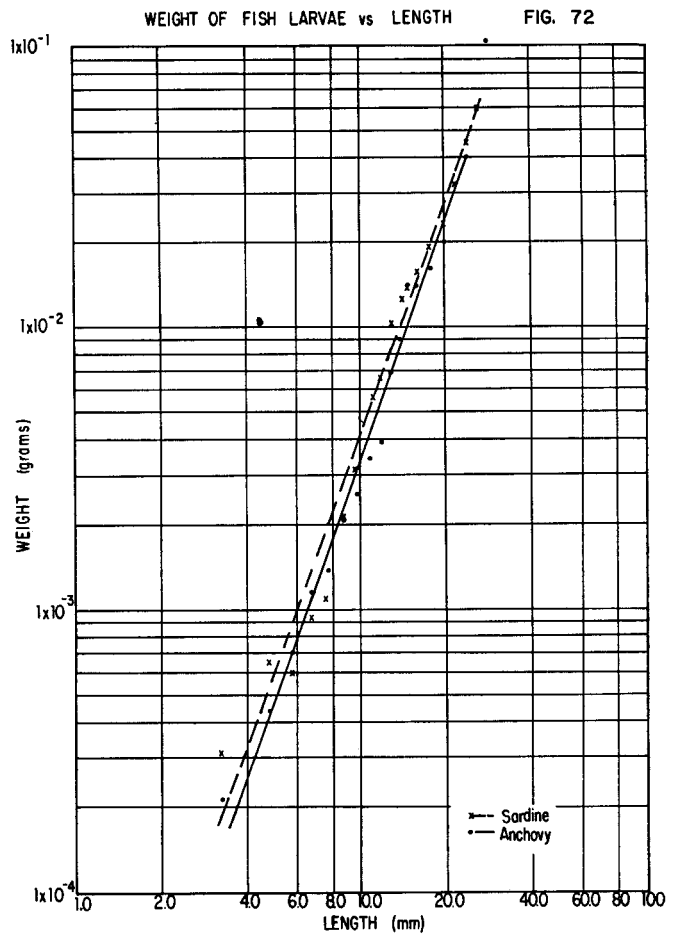
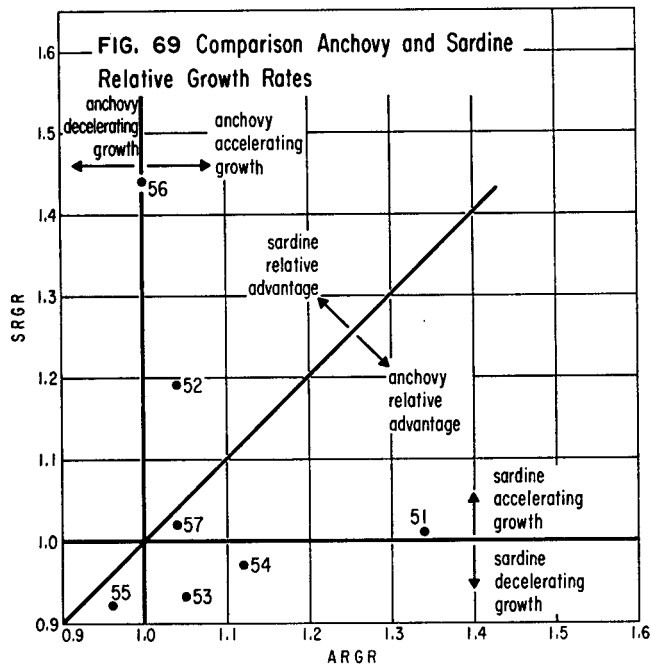

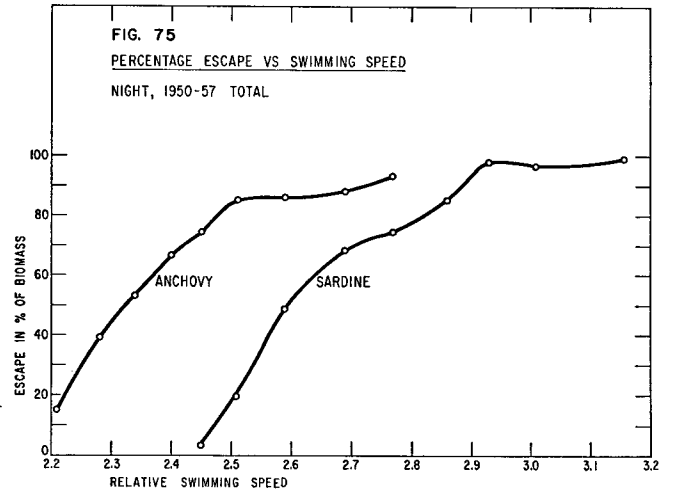
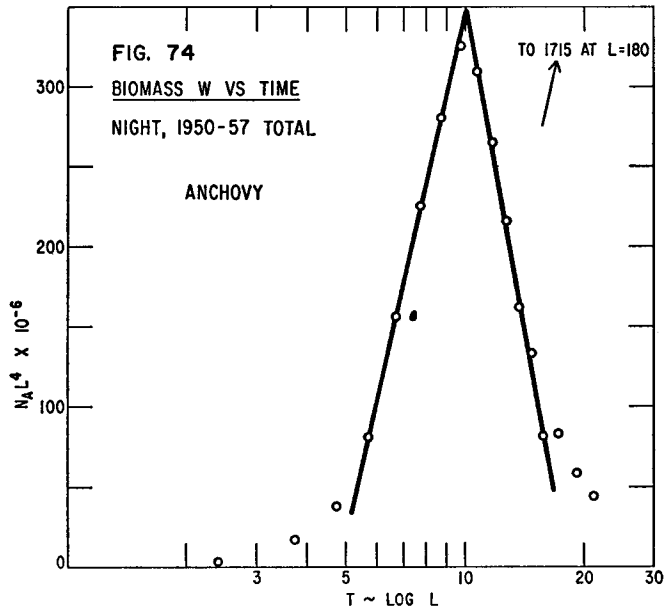

# CLIMATIC IMPLICATIONS DERIVED FROM THE COMPARISON OF BATHYTHERMOGRAPH (BT) DATA WITH TWO TYPES OF HISTORIC AND MODERN SEA SURFACE DATA

MARGARET K. ROBINSON 1

## INTRODUCTION

In order to study further the climatology of the Pacific Ocean as evidenced in the sea surface temperature record, three sets of historical data have been examined:

1. Sea surface temperature data in the Pacific Ocean taken between the years 1816 and 1889, tabulated by Makaroff (1894).

2. Sea surface temperature data in the Pacific Ocean taken between the years 1867 and 1875 by American ships, on file in the National Archives, Washington, D.C.

3. Sea surface temperature data in the 1-degree square, 37°N, 123°W, collected by ships of all nations in the years 1857-1955, furnished by the U.S. Department of Commerce, Weather Bureau, National Records Center, Asheville, North Carolina.

These three sets of historical sea surface data were compared statistically and graphically with average sea surface temperatures based on modern Bathythermograph (BT) data taken in the years 1941-1952 (Robinson, 1951, 1954, 1957; and Pattullo, Cochrane and Burt, 1950) and also with each other. The data at 37°N, 123°W, were also compared with San Francisco (Fort Point) tide station sea surface temperatures and with San Francisco air temperatures. The results were examined for evidence of the following: Do the 19th century temperatures differ significantly from the BT averages? If these differences are significant, is there geographic and time variation among them? Do trends in the sea surface temperature agree with trends described by meteorologists and other scientists?

The detailed description of the sample data and the methods of statistical analysis are contained in the Appendix. The Makaroff and American ship data were analysed together. However, the data in the Northeast Pacific were segregated from the data in the Marshall Islands area throughout the statistical analysis. The Weather Bureau data at 37°N, 123°W, were analysed and will be discussed separately. Throughout this discussion the signs of the anomalies indicate the direction of departure of the 19th century data from the modern data.

## DISCUSSION OF RESULTS

### *The Makaroff and American ship samples*

Figure 1 is a dual purpose location chart of the Makaroff and American ship samples. It shows not

<sup>1</sup>Contributions from the Scripps Institution of Oceanography, New Series.

only the geographic locations of the observations, but also whether the individual monthly anomalies were positive or negative. When the sample was considered as a whole, the 19th century sea surface temperatures were lower than the BT temperatures. The mean anomaly in the Northeast Pacific was  $-1.4^{\circ}\text{F}$  and 70% of the anomalies were negative. The range of the anomalies, however, was very large, from  $-11.5^{\circ}\text{F}$  to  $+7.5^{\circ}\text{F}$ . While some of the excessively large anomalies may be due to observational error, recent synoptic temperature charts in the North Pacific ocean have shown surface temperature anomalies of comparable magnitude (McGary et al., 1957, 1958, 1959).

The mean anomaly for the Marshall Islands portion of the sample was  $-0.8^{\circ}\text{F}$  and 81% of the anomalies were negative. The range of the anomalies was much smaller, from  $-4.0^{\circ}\text{F}$  to  $+2.5^{\circ}\text{F}$ .

The frequency distributions of the anomalies were found to be approximately normal. If the BT average temperatures and the 19th century average temperatures were the same, we would expect in a random sample of this size the mean anomaly to be zero. The negative mean anomalies for both the Northeast Pacific and the Marshall Islands samples are significantly different from zero with probabilities of such results occurring by chance being less than .0001.

Rms deviations of the anomalies were computed for both samples. For the Northeast Pacific sample the value was  $2.8^{\circ}\text{F}$ , and for the Marshall Islands sample it was  $1.2^{\circ}\text{F}$ . These values are consistent with the variability found in BT data in these same areas.

There were no systematic differences in the sizes of the anomalies when the Northeast Pacific data were divided into subsamples longitudinally or latitudinally. In the Marshall Islands sample the size of the anomalies increased with distance from the equator. The mean anomaly for the data between 15° and 20°N,  $-1.3^{\circ}\text{F}$ , was only  $0.1^{\circ}\text{F}$  less than the mean anomaly for the Northeast Pacific sample, but considerably smaller than those of the areas closer to the equator ( $-0.2^{\circ}\text{F}$  to  $0.6^{\circ}\text{F}$ ). No longitudinal differences could be noted.

Table 1 summarizes the statistics for the Northeast Pacific sample when the anomalies were segregated into time intervals of months and years, and Table 2 similar statistics for the Marshall Islands sample. When the sample was subdivided by months and years, it was found that the positive and negative mean anomalies were not randomly distributed in time. In the Northeast Pacific the mean anomalies were negative and statistically significant in 26 of

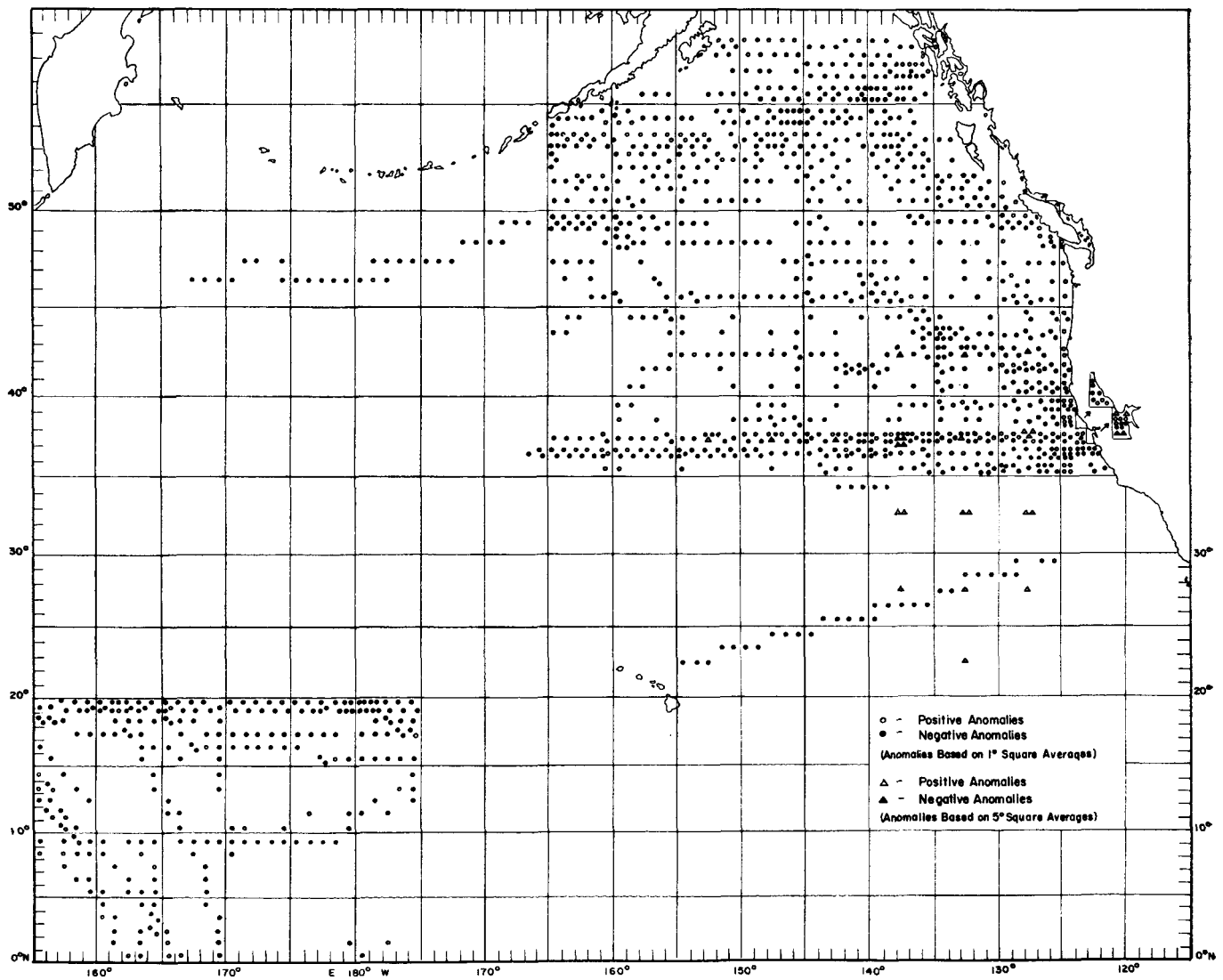

FIGURE 1. Location chart for Makaroff and American ship samples.

65 subsamples by two significance tests (see Appendix), and in 11 additional cases by one test: September 1816; September 1817; August 1824; August 1825; October and November 1826; October and November 1829; April, May, June, October and November 1848; July, September and October 1862; May, June, July, September and October 1863; April and July 1864; September 1867; June and September 1871; July, September, October and November 1873; January, February, April, July and September 1874; July 1875; and June 1889. The mean anomalies were positive and statistically significant in seven cases by both tests and in two cases by one test: December 1848; March and June 1864; February 1870; August 1873; August and October 1874; April and May 1889.

In the Marshall Islands sample, the mean anomalies were negative and statistically significant in 8 of the 23 subsamples by two tests, and in 7 additional cases

by one of the tests, as follows: January, March, April and November 1817; May 1824; October 1825; May and December 1826; June 1829; October and November 1862; April 1863; May 1880; April 1887; and May 1888. In May 1863, the mean anomaly was positive and statistically significant.

The more frequent occurrence of positive anomalies between 1863 and 1889 is in agreement with the findings of Hubbs (1948) and Willett (1951).

There were eight instances in the Northeast Pacific (none in the Marshall Islands area) where results indicated that the 19th century temperatures were approximately the same as the BT averages: October 1816; September 1826; December 1829; August 1864; June, July and December 1873; and November 1874.

In Tables 1 and 2, the means of all anomalies in a given year are listed. In only two cases was there a .95 of better probability that this mean was a good estimate of the true annual anomaly:  $-3.3^{\circ}\text{F}$  in

TABLE 1  
SUMMARY OF STATISTICS FOR NORTHEAST PACIFIC DATA

YEAR		JAN	FEB	MAR	APR	MAY	JUN	JUL	AUG	SEP	OCT	NOV	DEC	N <sub>y</sub>	$\bar{D}_y$	rms <sub>y</sub>	% N <sub>y</sub> Negative	No. of Ships
1816	$\bar{d}_n$									-1.8 6	-0.9 15	+3.0 1		22	<u>-1.0</u>	1.9	68	1
1817	$\bar{d}_n$									(-1.1 21)				21	(-1.1)	1.7	76	1
1824	$\bar{d}_n$								-1.6 7					7	-1.6	1.7	100	1
1825	$\bar{d}_n$								-1.4 9	-2.3 3				12	(-1.6)	1.4	92	1
1826	$\bar{d}_n$								-0.8 28	(-6.1 5)	(-6.5 11)			54	<u>-3.5</u>	4.1	61	1
1829	$\bar{d}_n$									(-5.2 11)	(-1.8 37)	+0.4 14		62	(-1.9)	2.6	76	1
1846	$\bar{d}_n$						-2.0 1							1	-2.0	---	100	1
1848	$\bar{d}_n$				(-1.1 26)	(-1.7 16)	(-5.8 17)				(-6.1 29)	(-2.7 23)	+2.2 4	115	(-3.3)	2.8	90	1
1862	$\bar{d}_n$							-8.0 1		(-1.5 37)	(-4.4 6)			44	(-2.0)	1.6	100	2
1863	$\bar{d}_n$			+1.5 1	+3.5 1	(-3.7 31)	(-1.0 34)	(-5.2 5)		(-4.2 4)	(-2.3 88)	(-1.5 1)		163	(-2.3)	2.3	83	3
1864	$\bar{d}_n$			(+2.7 11)	(-0.7 55)	(-2.0 3)	(+4.1 5)	(-3.1 28)	+0.3 12					114	(-0.7)	2.7	61	2
1867	$\bar{d}_n$									-1.8 5*				5*	-1.8	1.4	100	1
1870	$\bar{d}_n$	+1.0 2*	(+2.5 4*)							(-0.7 8*)				14*	+0.4	2.0	36	3
1871	$\bar{d}_n$						(-2.5 27)			(-1.2 52)				79	(-1.6)	2.9	71	2
1872	$\bar{d}_n$			(-0.9 5*)	(+0.9 4*)									9*	+0.9	1.5	22	2
1873	$\bar{d}_n$						(+0.1 25)	(-0.2 40)	(+1.9 4)	(-1.3 63)	(-4.9 44)	(-2.2 9)	(-0.2 20)	205	(-1.6)	2.9	68	2
1874	$\bar{d}_n$	(-0.5 47)	(-1.4 21)		(-0.8 44)		(-0.2 5*)	(-0.8 43)	(+3.2 36)	(-2.8 25)	(+2.6 23)	(+0.8 38)		282	0.0	2.4	55	3
1875	$\bar{d}_n$							(-0.8 22*)						22*	-0.8	1.8	82	2
1889	$\bar{d}_n$				(+3.0 5)	(+5.2 8)	(-2.2 43)							56	(-0.7)	3.3	64	1
														N 1287	$\bar{D}$ (-1.4)	rms 2.8	% of N Negative 70%	Total Ships 21

\* Data tabulated by 5-degree squares.  
Single underline indicates .95 significance by percentage test.  
Double underline indicates .95 significance by standard deviation of mean test.

Circles indicate .95 significance by both tests.  
See Appendix for identification of symbols.

1848 in the Northeast Pacific and  $-0.9^\circ\text{F}$  in 1817 in the Marshall Islands area. For all other years the monthly samples were too few to justify the assumption that the mean of all anomalies within a given year represents a true annual anomaly.

Further consideration of the locations of the very large positive and negative mean monthly anomalies belies what at first appears in Figure 1 to be a random distribution in space, even as Tables 1 and 2 revealed that positive and negative anomalies are not randomly distributed in time. High positive anomalies were localized in August 1874, near the Aleutians; in October 1874, in the Gulf of Alaska; in June 1864, near  $47^\circ\text{N}$ ,  $140^\circ\text{W}$ ; and in May 1889, along the coast between San Francisco and Vancouver Island. The occurrence of the very high temperatures in August 1874, reported by the U.S.S. *Tuscarora* south and east of the Aleutians, were substantiated by data collected by the U.S.S. *Portsmouth* in October 1874, in the Gulf of Alaska. It is of interest to note that the temperatures reported by both of

these ships were approximately the same as those recently reported in these areas and months during the warm years of 1957-1959 (McGary et al., 1957, 1958, 1959).

Large negative anomalies were localized in current regions: the California Current—November 1826, October 1829, and October 1873; the Alaskan Current—October 1826 and 1829; and the Aleutian or Subarctic Current—June and October 1848.

Anomalies based on data collected by the Russian ship *Krotkiy*, which sailed south from Sitka through the Alaskan Current to  $35^\circ\text{N}$  at about  $135^\circ\text{W}$  in October and November 1826, were the largest of the negative anomalies. Seventeen anomalies fell between  $-6.0^\circ\text{F}$  and  $-11.7^\circ\text{F}$ . In September 1826, the *Krotkiy* had crossed the Gulf of Alaska from the west to Sitka, and the mean anomaly of their September data was only  $-0.9^\circ\text{F}$ . The mean anomaly for October 1826 was  $-6.1^\circ\text{F}$ , and for November 1826,  $-6.5^\circ\text{F}$ . If these *Krotkiy* data are, in fact, true ocean tempera-

TABLE 2  
SUMMARY OF STATISTICS FOR MARSHALL ISLANDS DATA

YEAR	JAN	FEB	MAR	APR	MAY	JUN	JUL	AUG	SEP	OCT	NOV	DEC	N <sub>y</sub>	$\bar{D}_y$	rms <sub>y</sub>	% N <sub>y</sub> negative	No. of Ships
1816	$\bar{d}_n$				+0.5 1								1	+0.5		0	1
1817	$\bar{d}_n$	$\frac{-0.5}{15}$	$\frac{-0.5}{2}$	$\frac{-1.1}{4}$	$\frac{-3.3}{4}$					$\frac{-0.8}{18}$			43	$\frac{-0.9}{18}$	1.0	77	1
1824	$\bar{d}_n$				$\frac{-2.0}{2}$								2	$\frac{-2.0}{2}$	2.0	100	1
1825	$\bar{d}_n$			+1.9 1						$\frac{-4.0}{1}$			2	-1.0	4.3	50	1
1826	$\bar{d}_n$				$\frac{-1.9}{8}$							$\frac{-1.8}{29}$	37	$\frac{-1.8}{29}$	1.2	92	1
1827	$\bar{d}_n$		+0.1 2										2	+0.1	0.7	50	1
1829	$\bar{d}_n$					$\frac{-1.0}{21}$							21	$\frac{-1.0}{21}$	0.7	95	1
1858	$\bar{d}_n$								0.0 2				2	0.0	0.3	50	1
1862	$\bar{d}_n$									$\frac{-1.0}{11}$	$\frac{-1.2}{18}$		29	$\frac{-1.1}{18}$	0.9	93	1
1863	$\bar{d}_n$			$\frac{-0.3}{17}$	$\frac{+0.8}{18}$								35	-0.2	1.0	48	2
1880	$\bar{d}_n$				$\frac{-0.9}{26}$								26	$\frac{-0.9}{26}$	1.1	100	1
1887	$\bar{d}_n$			$\frac{-2.2}{8}$	$\frac{+1.2}{1}$								9	$\frac{-1.9}{8}$	1.5	89	2
1888	$\bar{d}_n$				$\frac{-0.6}{44}$	$\frac{-0.2}{4}$							48	$\frac{-0.5}{44}$	0.8	77	2
													N 257	$\bar{D}$ $\frac{-0.8}{12}$	rms <sub>y</sub> 1.2	% of N Negative 81%	Total Ships 11

Single underline indicates .95 significance by percentage test.  
Double underline indicates .95 significance by standard deviation of mean test.

Circles indicate .95 significance by both tests.  
See Appendix for identification of symbols.

tures, the fall of 1826 must truly have been a remarkably cold period.

In general, widespread geographic coverage adds insight to the significance of small samples. Generalizations concerning year-to-year differences or climatic trends are not warranted when a sample is limited to a few months within a year. Thus, the conclusions which may be drawn from the Makaroff and American ship samples are limited to specific times and small areas.

**Weather Bureau sample, data at 37°N, 123°W.**

The 98-year record of sea surface temperatures at 37°N, 123°W, was approached from a different point of view than the Makaroff and American ship samples, primarily because the temperature means for each month based on the entire record are a better frame of reference for climatic purposes than are the BT data from the years 1941-1952 in the same area. This can best be seen in Figure 2 which summarizes in frequency diagrams the monthly means and the extremes of the Weather Bureau sample and the BT data.

It was found that the monthly extremes of all Weather Bureau data for all months with the exception of February, March and December maxima, occurred after 1941. Thus, a second maximum for each of those three months from the post 1941 data was added to the chart for better comparison in time with the BT data. It is a surprising and puzzling fact that all but three monthly extremes in the Weather Bu-

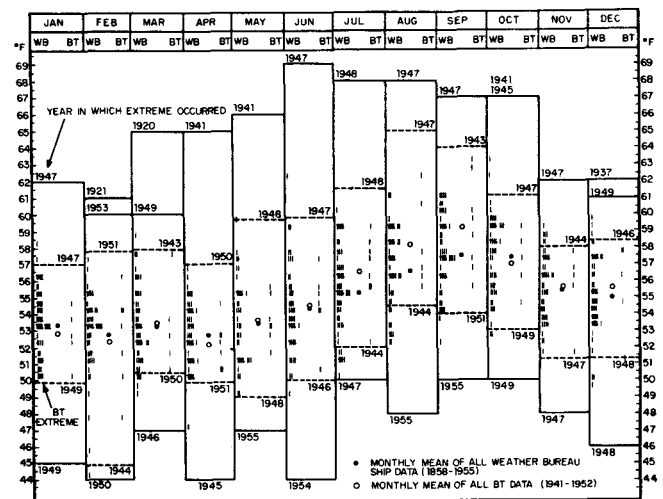

FIGURE 2. Summary of monthly means and extremes of Weather Bureau ship data and BT data at 37°N, 123°W.

reau data should have occurred in the post-1941 period. While some of the extremes may have been errors, it would be highly coincidental if all were. However, it may be due to larger numbers of observations in the post-1941 sample, since one would expect the range of temperatures to increase with increase in number of observations. No estimate of this effect could be made since the numbers of observations were not listed for the pre-1941 Weather Bureau data.



It is obvious from Figure 2 that year-to-year differences are large. The BT 1941-1952 mean monthly sea surface temperatures were higher in 8 months and lower in 4 months than the long-period Weather Bureau means. This is evidence that during the period 1941-1952, most of the temperatures in this region were higher than those of a great part of the previous 84 years. (See also Figures 3, 5, and 6.)

Table 3  
MONTHLY STANDARD DEVIATIONS AT 37°N, 123°W  
(Estimated from Range)

	Jan.	Feb.	Mar.	Apr.	May	June	July	Aug.	Sep.	Oct.	Nov.	Dec.	Average All Months
Weather Bureau data 1941-1955...	2.2	1.9	1.8	2.4	2.2	2.9	2.8	2.9	2.7	2.6	2.1	1.4	2.4°F
BT Data 1941-1952.....	1.9	3.8	2.0	1.9	2.6	2.5	2.4	2.9	2.4	2.1	2.0	2.8	2.4°F

While the range of temperatures within individual months was greater in the Weather Bureau sample than in the BT data, standard deviations (see Table 3) show variability, in general, to be approximately the same in both samples. It has been previously shown from an investigation of shore station temperatures along the West Coast between Alaska and Southern California that between 1948 and 1955 variability in sea surface temperatures was lower than average in this region (SIO Ref. 60-30, 1960).

Figure 3 presents the chronological anomalies of the Weather Bureau sample computed from the long-period monthly means of the sample. Different symbols are used for each season in order to draw attention to seasonal differences, and to the occurrence of persistence of positive or negative anomalies. While much of the month-to-month variation appears random in size and sign, there are numerous periods where there is evidence of persistence in the signs of anomalies over periods of several months. In 1941-1942 sixteen consecutive positive anomalies can be seen, and in 1916-1917, fourteen consecutive negative anomalies. Roden and Groves (1960), have found evidence of persistence of from four to six months in sea surface temperature data in two locations in the North Pacific. Robinson (1960), showed occasional periods of persistence up to eighteen months in length in the Pacific Coast shore station sea surface temperature data of Alaska, Canada and the United States.

Weather Bureau tabulations did not include the number of observations on which the monthly means were based for the period prior to 1941. It was thus impossible to compute the significance of the monthly mean anomalies for the period prior to 1941. Table 4 presents the monthly mean anomalies for the period 1941 to 1955. Seventy-nine of the one hundred and forty monthly means are significantly different from the all-data means; of these fifty-four were higher than the all-data means.

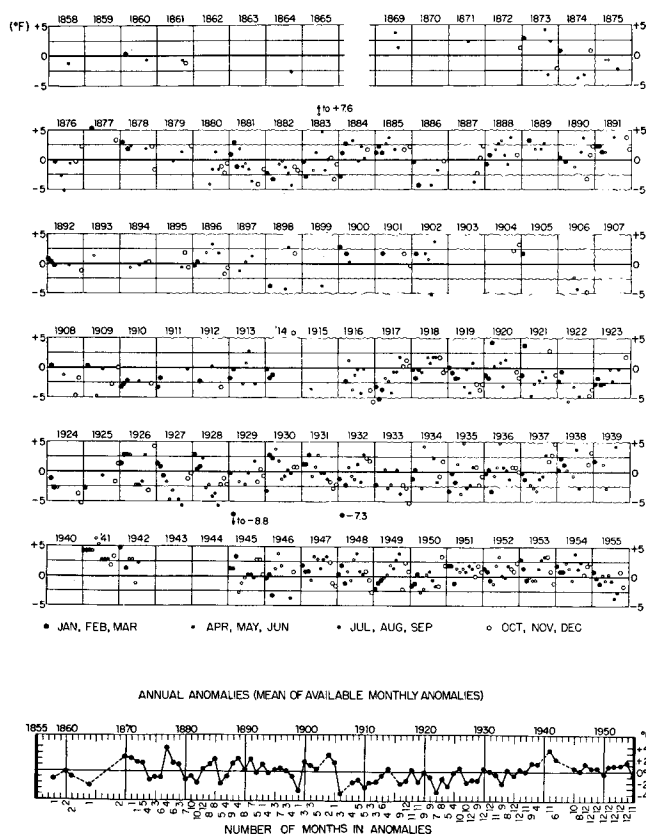

FIGURE 3. Top: Monthly anomalies 1858-1955 at 1-degree square, 37°N, 123°W, plotted to show seasonal relationships. Bottom: Annual anomalies.

Along the bottom of Figure 3 the means of the available monthly anomalies as an estimate of the annual anomalies are presented. Prior to 1920, the number of years with data in most months is rather small; thus, only general trends in these anomalies may be considered to be real. During the period 1870 to 1905, there are more frequent positive than negative anomalies; whereas from 1906 to 1935 negative anomalies predominated, and from 1936 to 1955 positive anomalies were again the most frequent.

In the following years there is a probability of .05 or less that the number of positive or negative monthly anomalies could have occurred by chance: positive anomalies—1885, 1891, 1941, 1947, 1951, and 1954; and negative anomalies—1882, 1886, 1910, 1916, 1919, 1922, 1923, and 1927. The probability that the sign of the mean of the monthly anomalies would be the same as the sign of the true annual mean was .95 in the following years: warm years—1878, 1888, 1889, 1938 and 1942; and cold years—1876, 1921, 1929, and 1933.

These findings agree, in general, with the trends in air temperatures described by Willett (1950), Kincer (1946) and with trends in the Atlantic sea surface temperatures described by Smed (1952).

The years 1926 and 1931, which are remarkably warm in Canadian and American Pacific shore station data, are warm peaks within the cold period, but

TABLE 4  
ANOMALIES FROM ALL-DATA MONTHLY MEANS

1-degree square, 37°N, 123°W

	Jan.	Feb.	Mar.	Apr.	May	June	July	Aug.	Sept.	Oct.	Nov.	Dec.
1941.....	<u>+4.1</u>	<u>+4.2</u>	<u>+4.2</u>	<u>+4.1</u>	<u>+6.0</u>	<u>+5.1</u>	<u>+2.5</u>	<u>+2.5</u>	+2.5	<u>+1.8</u>	<u>+3.4</u>	
1942.....	<u>+4.6</u>		+1.3	<u>+2.5</u>	+2.5	-1.4	+2.2					
1945.....		+1.2	<u>+3.3</u>	<u>-2.8</u>	<u>-1.2</u>	-0.3		+0.4	-0.4	<u>+2.5</u>	<u>+2.5</u>	+0.1
1946.....	-0.4	+0.3	<u>-3.0</u>	+1.4	<u>+3.5</u>	+1.6			<u>-3.5</u>	+0.6		
1947.....	<u>+1.6</u>	+0.5	+0.8	-0.8	<u>+3.2</u>	<u>+2.7</u>	<u>+1.3</u>	<u>+2.8</u>	<u>+3.3</u>	<u>+2.2</u>	<u>-1.0</u>	<u>-1.6</u>
1948.....	+0.1	<u>+1.8</u>	<u>-1.0</u>	+0.7	-0.9	<u>+2.7</u>	<u>+3.7</u>	+0.5	+0.4	+0.9	<u>-0.8</u>	<u>-2.5</u>
1949.....	<u>-2.2</u>	<u>-1.2</u>	<u>-0.9</u>	-0.3	+0.3	<u>+1.5</u>	<u>+1.4</u>	<u>+2.5</u>	<u>+3.6</u>	<u>-2.0</u>	<u>+2.2</u>	+0.7
1950.....	<u>-1.8</u>	<u>-1.2</u>	+0.2	<u>-2.5</u>	<u>-2.4</u>	+0.1	+0.6	-0.7	-1.5	-1.9	<u>+3.3</u>	<u>+1.5</u>
1951.....	<u>+1.6</u>	<u>+1.5</u>	<u>-1.3</u>	<u>+1.0</u>	+0.5	+1.3	+0.7	<u>+1.6</u>	+1.3	0.0	<u>+1.7</u>	+0.5
1952.....	<u>+1.0</u>	+0.9	-0.6	<u>-1.4</u>	+1.8	<u>+3.4</u>	0.0	-0.3	+1.9	+1.1	+0.6	<u>+2.0</u>
1953.....	<u>+2.7</u>	<u>+1.3</u>	-0.5	-0.3	-0.5	-0.5	+1.3	<u>+2.6</u>	<u>+3.3</u>	<u>+3.1</u>	+0.8	<u>-1.4</u>
1954.....	<u>+1.9</u>	+0.8	+0.6	<u>+2.1</u>	<u>+1.0</u>	-0.8	<u>+3.8</u>	+1.1	<u>+2.0</u>	+0.1	<u>+1.9</u>	<u>+2.3</u>
1955.....	+0.5	-0.2	<u>-1.0</u>	+0.1	<u>-0.9</u>	+0.2	-0.7	<u>-3.5</u>	<u>-2.7</u>	+0.6	<u>-1.6</u>	

Underlined values exceed  $\frac{\sigma}{\sqrt{n}}$  at .05 or less probability level.

the number of positive anomalies is not significant in these years. The significantly cold years of 1922 and 1933 are in agreement with the Pacific Coast shore station data (SIO Ref. 60-30, 1960).

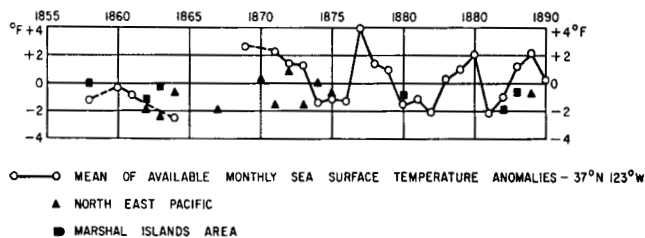

FIGURE 4. Comparison of annual sea surface temperature anomalies at 37°N, 123°W and in the Northeast Pacific Ocean and Marshall Islands area.

The climatic relationship between the Weather Bureau data and data from other sources is shown in Figures 4, 5, and 6. In Figure 4, the Weather Bureau mean anomalies for the years 1858 to 1889 are compared with the mean anomalies of the Makaroff and American ship samples during the same period, but in different areas. The sign of the annual anomalies is the same in only half of the comparisons. This result is not surprising since as shown above for the

Makaroff and American ship sample, in only a few cases was it probable that the sum of the individual anomalies in a given year was a good estimate of the true annual anomaly.

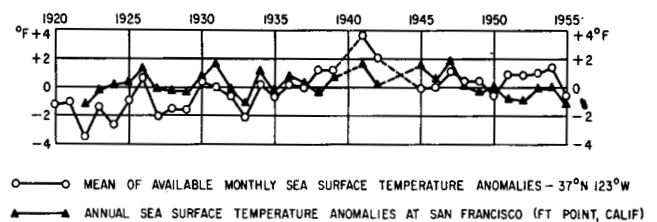

FIGURE 5. Comparison of annual sea surface temperature anomalies at 37°N, 123°W and at San Francisco (Fort Point), California.

In Figure 5, the annual anomalies at 37°N, 123°W, for the Weather Bureau sample are compared with the annual anomalies for the San Francisco (Fort Point) sea surface temperature data for the years 1922-1955. The reference base, for the computation of the anomalies, was the long-period mean for the period 1922-1955 for both sets of data.

There is good agreement between the sign of the anomalies and the direction of change of the anomalies

from year to year at the two locations, with the exception of the period 1949-1954.

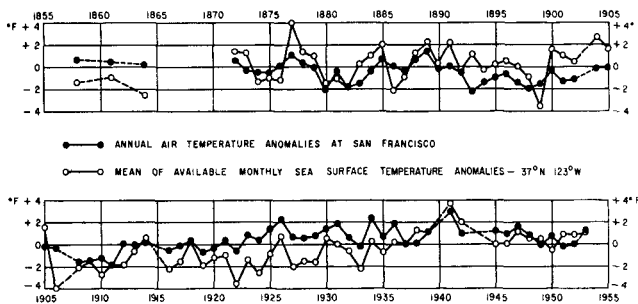

FIGURE 6. Comparison of annual sea surface temperature anomalies at 37°N, 123°W and air temperature anomalies at San Francisco, California.

In Figure 6, Weather Bureau annual sea surface temperature anomalies at 37°N, 123°W, are compared with annual air temperature anomalies at San Francisco, for those years between 1858 and 1953 that data exist at both places. The long-period means used as the basis of reference for computing the anomalies include only those data common to both. However, the annual air temperature anomalies are based on data in all twelve months. Those at 37°N, 123°W, are the means of available data within each year.

This figure shows evidence of a correlation between ocean temperatures and air temperatures. There is general agreement in the signs of the anomalies, with notable exceptions. There is closer agreement, however, in the trends of the anomalies from year to year at the two locations.

In order to evaluate quantitatively the relation between offshore oceanic sea surface temperature anomalies and onshore sea surface and air temperature anomalies, the correlation coefficients shown in Table 5 were computed. Also listed are the probabilities of obtaining these results by chance.

Highly significant positive correlations between *monthly* anomalies of sea surface temperature at 37°N, 123°W, and those at San Francisco (Fort Point) were found in the months November to June. In July, the correlation was negative and not significant, probably because of upwelling along shore.

A highly significant positive correlation was also found when *annual sea surface temperature anomalies* for the offshore and onshore stations were compared. A further significant positive correlation was found between *annual sea surface temperature anomalies* at 37°N, 123°W, and *annual air temperature anomalies* at San Francisco.

For comparison, Table 5 includes the highly significant correlation between *annual sea surface temperature anomalies* at San Francisco (Fort Point) and *annual air temperature anomalies* at San Francisco previously reported by Hubbs (1948), and the much lower but still significant correlation between the *monthly BT sea surface temperature anomalies* at 37°N, 123°W, and *monthly sea temperature anomalies* at San Francisco from Robinson (1957).

TABLE 5

CORRELATION COEFFICIENTS (r) AND PROBABILITIES OF THEIR OCCURRENCE BY CHANCE

A. Sea Surface Temperatures 37°N 123°W (WB) vs. San Francisco (Fort Point)

1. Between Monthly Anomalies, by months, (1922-1954)

	Jan.	Feb.	Mar.	April	May	June
r.....	.597	.619	.548	.609	.521	.400
n.....	26	25	22	27	22	26
Prob.....	.001	<.001	.006	.001	.009	.033
	July	Aug.	Sept.	Oct.	Nov.	Dec.
r.....	.051	.562	.422	.382	.603	.632
n.....	21	24	25	23	24	22
Prob.....	---	.003	.025	.063	.001	.001

2. Between Monthly Anomalies, all months, (1922-1934)

r.....	.527
n.....	287
Prob.....	<.001

3. Between Annual Anomalies (1922-1953)

r.....	.486
n.....	29
Prob.....	.005

B. Sea Surface Temperatures 37°N 123°W (WB) vs. Air Temperatures San Francisco

1. Between Annual Anomalies (1858-1953)

r.....	.390
n.....	78
Prob.....	.003

2. Between Annual Anomalies (1922-1953)

r.....	.477
n.....	29
Prob.....	.006

C. Sea Surface Temperatures, San Francisco (Fort Point) vs. Air Temperatures, San Francisco

1. Annual Anomalies (1922-1953)

r.....	.801
n.....	29
Prob.....	<.001

D. Sea Surface Temperatures 37°N 123°W (BT) vs. San Francisco (Fort Point)

1. Monthly Anomalies, all months, (1941-1952) from Robinson (1957)

r.....	.273
n.....	75
Prob.....	.022

CONCLUSION

Let us return to the questions raised in the introduction:

1. Do the 19th century temperatures differ significantly from the BT averages? Yes. The mean of the Makaroff and American ship sample temperatures was less than that of the BT averages in the same locations. In some months of some years, the 19th century temperatures were higher than the BT averages.
2. If these differences are significant, is there geographic and time variation among them? A large part of the differences was significant. The differences varied with geographic location. Anomalies were small in equatorial regions, and large in high latitudes and in current regions. The anomalies also varied with time. The significant

anomalies were negative prior to 1864. Between 1864 and 1889, there were both significant positive and negative anomalies, though negative anomalies were more frequent.

3. Do trends in the sea surface temperature agree with trends described by meteorologists? Yes. The occurrence of the significant positive anomalies between 1864 and 1889 in the Makaroff and American ship samples, and the occurrence of a majority of positive anomalies between 1870 and 1905, a majority of negative anomalies between 1906 and 1935, and a majority of positive anomalies from 1936 to 1955 in the Weather Bureau sample are examples of agreement of the trends in sea surface temperatures with those in air temperatures described by meteorologists.

The correlation of offshore and onshore sea and air temperatures demonstrated in this paper further serves to point up the fact that the inter-relationship between air and sea surface temperatures needs further investigation in the open ocean. Such an investigation would expand our knowledge of the climatic history of the Pacific Ocean. Those years for which there are also historic weather maps (1889-1955) deserve special emphasis with the ultimate objective of forecasting sea surface temperatures and long-range weather.

#### ACKNOWLEDGMENTS

This paper represents results of research carried out by the University of California, under contract with the Office of Naval Research. Reproduction in whole or in part is permitted for any purpose of the U.S. Government.

This research also received support from the California Cooperative Oceanic Fisheries Investigations, a project sponsored by the Marine Research Committee of the State of California.

#### REFERENCES

- Fisher and Yates, 1948. *Statistical tables for Biological Agricultural and Medical Research*. 3rd Ed. Oliver and Boyd, London, England. p 46.
- Hoel, Paul G., 1947. *Introduction to Mathematical Statistics*. John Wiley and Sons, Inc., N.Y., 246 pp.
- Hubbs, Carl L., 1948. Changes in the fish fauna of western North America correlated with changes in ocean temperature. *J. Mar. Res.* 7: 459-482.
- Kincer, J. B., 1946. Our climate change. *Transactions Am. Geo. Un.* 27 (3): 342-347.
- Makaroff, S., 1894. *Le Vitiav et l'Océan Pacifique I and II*. St. Petersburg, Russie, 848 pp.
- McGary, James W., Calloway, R. J. and Mendiola, E. W., 1957, 1958, 1959. Synoptic sea surface temperature charts. Fish. and Wild. Serv., Pac. Oce. Fish. Invest. (Honolulu Biological Laboratory, B.C.F.)
- Pattullo, June, Cochran, John D. and Burt, Wayne V., 1950. Sea temperature in the Aleutian Islands area. Univ. Calif. Scripps Inst. Oceanogr., *Oceanographic Rept.* 24 (Mimeo.).
- Robinson, Margaret K., 1951. Sea temperature in the North Pacific area, 20°-40°N, 125°-155°W. Univ. Calif. Scripps Inst. Oceanogr. *SIO Ref.* 51-20. 14 (Mimeo.).
- Robinson, Margaret K., 1954. Sea temperature in the Marshall Islands area, Bikini and nearby atolls. *Geol. Survey Prof. Papers* 260D, 10.
- Robinson, Margaret K., 1957. Sea temperature in the Gulf of Alaska and in the Northeast Pacific Ocean, 1941-1952. *Bull. Scripps Inst. Oceanogr.* 7 (1): 98.
- Robinson, Margaret K., 1960. The use of a common reference period for evaluating climatic coherence in temperature and salinity records from Alaska to California. *Marine Research Committee, Calif. Coop. Oceanic Fish. Invest. Rept. VIII*. Sacramento.
- Roden, Gunnar and Groves, Gordon C., 1960. On the statistical prediction of ocean temperatures. *J. Geo. Review* 65 (1): 249-263.
- Smed, Jens, 1952. Variation of the surface temperature in the northern North Atlantic during 1876-1952. Conseil Permanent International pour l'Exploration de la Mer. *Annales Biologiques* 9: 19-21.
- Smithsonian Institution, 1927, 1934 and 1947. *Smithsonian Misc. Coll.* 79, 90 and 105. Smithsonian Institution, Wash. D.C.
- Tippett, L.H.C., 1925. On the extreme individuals and the range of samples taken from a normal population. *Biometrika* 17: 364-387.
- U.S. Coast and Geodetic Survey, 1956. Surface water temperatures at tide stations, Pacific coast *Special Publication* 280.
- U.S. Weather Bureau, 1952. *Climatological Data California*. 45-56. 1941-1952.
- University of California, Scripps Institution of Oceanography, 1960. Temperature and salinity anomaly charts for 24 Canadian and American shore stations based on a common reference period. *SIO Ref.* 60-30.
- Willett, H. C., 1949. Long-period fluctuation of the general circulation of the atmosphere. *J. Met.* 6, No. 1.
- Willett, H. C., 1950. Temperature trends of the past century. *Centenary Proceedings of the Royal Met. Soc.*: 195-206.
- Willett, H. C., 1951. Extrapolation of sunspot-climate relationships. *J. Met.* 8 (1): 1-6.

**APPENDIX**

**DESCRIPTION OF SAMPLE DATA**

Makaroff's (1894) tabulations of Pacific Ocean sea temperature data included all observations known to him which had been collected between 1816 and 1889. From his collection only those data were selected for this analysis that were in areas where BT temperature data had already been analyzed and results published (Robinson, 1951, 1954, 1957; and Pattullo, Cochrane and Burt, 1950).

Table 6 lists the number of observations from the Makaroff collection in the Northeast Pacific Ocean by year, month, and by ship's name. There were 885 observations selected for analysis in this area. Of this total, 671 were collected by 11 Russian ships, 202 by *USS Tuscarora* and 12 by *HMS Challenger*. These data were taken in 15 of the years between 1816 and 1889.

**TABLE 6**  
**MAKAROFF SHIP LIST**  
**Gulf of Alaska Observations**

Year	Ship	Month	Observations		
1816	Rurik	September	6		
		October	15		
		November	1		
1817	Rurik	September	21		
1824	Predpriatie	August	7		
1825	Predpriatie	August	9		
		September	3		
1826	Krotkiy	September	28		
		October	15		
		November	11		
1829	Krotkiy	October	11		
		November	37		
		December	14		
		June	1		
1846	Herald	June	1		
1848	Atcha	April	26		
		May	16		
		June	17		
		October	29		
		November	23		
		December	4		
		September	37		
1862	Abrek	October	6		
		July	1		
1863	Abrek	March	1		
		October	51		
1863	Rynda	April	1		
		May	31		
		June	34		
		July	3		
		November	1		
		Bogatir	September	4	
			October	37	
			March	11	
		1864	Abrek	April	55
				June	5
July	28				
August	12				
August	4				
September	19				
October	34				
1873	Tuscarora	November	9		
		December	20		
		January	37		
		July	43		
1874	Tuscarora	August	36		
		May	3		
		July	12		
1875	Gaydamik	May	3		
1889	Challenger	July	12		
		April	5		
1889	Kreisser	May	8		
		June	43		
TOTAL			885		

Table 7 similarly lists the observations in the Marshall Islands area. Here there were 257 observations collected in 13 of the years between 1816 and 1888. Of this total 255 were taken by 10 Russian ships and 2 by *HMS Blossom*. In eight of the years, there were data in both areas.

**TABLE 7**  
**MAKAROFF SHIP LIST**  
**Marshall Islands Observations**

Year	Ship	Month	Observations
1816	Rurik	May	1
		January	15
1817	Rurik	February	2
		March	4
		April	4
		November	18
		May	2
1824	Predpriatie	May	2
1825	Predpriatie	April	1
		October	1
1826	Krotkiy	December	29
1827	Blossom	March	2
1829	Krotkiy	June	21
1858	Novara	September	2
1862	Abrek	October	11
		November	18
		April	7
1863	Abrek	May	11
		April	10
		May	7
1880	Djiguit	May	26
		April	8
1887	Vitiaz	April	8
		May	1
1888	Razboinik	May	39
		June	4
		May	5
1888	Rynda	May	5
		May	5
Total			257

The unpublished American ship data were obtained from the National Archives, Washington, D.C. The data, totalling 402, are listed in Table 8 by date and by ship's name. All data were in the Northeastern Pacific and were collected in seven of the years between 1867 and 1875.

Both the Makaroff collection and the American ship data were tabulated by 1-degree squares and were segregated by months and by years, with the exception of 43 of the American ship observations which were tabulated by 5-degree squares (see Table 8).

There were only 8 instances where 2 ships took observations in the same month and year, and even in these cases none were within the same 1-degree square but only in the same general area. It was therefore possible to verify results in only 8 cases by comparing data from different sources. (Fortunately verification, not disproval, did result from these comparisons).

The third sample selected for analysis was obtained from the U.S. Department of Commerce, Weather Bureau, National Records Center, Asheville, North Carolina.

These data include tabulations of monthly means and range of sea surface temperature for the 1-degree square, 37°N, 123°W. The IBM print-outs of

TABLE 8  
AMERICAN SHIP LIST  
Northeast Pacific Area

Year	Ship	Month	Observations
1867	Jamestown*	August	5
1870	Jamestown*	January	2
	Saginaw*	February	4
	Kearsarge*	September	8
1871	Cyane	June	27
	Jamestown	September	52
1872	Mohican*	April	5
	Pensacola*	May	4
1873	China	June	25
		July	40
		September	44
		October	10
1874	China	January	10
		February	21
		April	44
	Portsmouth	September	25
		October	23
		November	38
	Pensacola*	June	5
1875	Portsmouth*	July	10
	Total		402

\* Data tabulated by 5-degree squares.

these data listed monthly means in 83 of the 98 years between 1857 and 1955, and in 564 individual months of the 996 months during these 83 years. The number of different ships collecting the data in each month was not listed. Most unfortunate for statistical purposes, the number of observations on which the monthly means were based was omitted for the years prior to 1941, severely limiting the statistical usefulness of the data between 1857 and 1941.

The Weather Bureau sea surface temperature data were compared with BT temperature data in this area analyzed by Robinson (1957). Additional data used in this analysis were: 1) sea surface temperatures collected at San Francisco (Fort Point), California tide station (U.S.C.G.S., 1956) and 2) air temperatures, San Francisco weather station, (Smithsonian Institution, 1927, 1934, 1947, and U.S. Weather Bureau, 1952.)

#### RELIABILITY OF THE SAMPLE DATA

It is difficult to evaluate the reliability of the individual 19th century observations. Surely the positions of the observations were accurate within a unit area of 1° of latitude and longitude. Nineteenth century sailors were expert navigators and they would have been able to make corrections for periods when they sailed by dead-reckoning. Fahrenheit had invented the mercury thermometer in 1714. By 1816, accurate mercury thermometers must have been available. Observers' errors in reading thermometers or in transcribing data are always possible. For this reason, single observations should be accepted with caution, or, at times, even those taken by a single ship. We can never be sure how many times an untrained observer lifted a thermometer from a bucket of sea water, raised it to eye-level to read, but left the wet mercury bulb to the mercy of the wind.

However, Makaroff did critically evaluate the data which he tabulated. He spent an entire year examining ships' logs and published accounts of expeditions for description of methods, instruments and thermometer calibrations. He published only those data which he believed to be sufficiently accurate for scientific purposes (Makaroff, 1894, pp. 235-238).

The author transcribed the American ship data from the original ships' logs. Nothing was listed in these ships' deck logs concerning thermometer calibrations, but the data were accepted if the variation of temperature from observation to observation along the ship's track was consistent with that found in our modern temperature charts. That is, it was accepted if a rapid increase or decrease of temperature occurred when the ship sailed in the direction of the temperature gradient and little change of temperature when it sailed normal to the gradient.

The reliability of the Weather Bureau sample is unknown. It is made up of data from sources similar to the American ship sample. It is not known if any screening or evaluation of the data was done by the Weather Bureau. The mean temperatures, however, are based on data from numerous ships and the effect of random errors should be at a minimum.

It is equally difficult to evaluate the reliability of the BT smoothed averages. The root mean square difference of the BT smoothed monthly average contoured isotherms from the BT raw averages in the Northeast Pacific was 1.7°F with a mean difference of -0.05°F, based on 3,438 comparisons. These figures imply that no bias was introduced by the smoothing. They do not indicate the reliability nor accuracy of the BT average contours. For the purposes of this study we will assume that they are climatically representative means for the period for which BT data were analyzed—i.e., 1941-1952 for the Northeast Pacific; 1941-1949 in the area south of 35°N between San Francisco and Hawaii; 1942-1948 in the Aleutian Island area; and 1942-1951 in the Marshall Islands area.

The variability of sea-surface temperature can best be demonstrated by computations of standard deviations from their monthly means of individual observations taken in different years at a single location. In the Northeast Pacific, on weather stations and at other locations with numerous BT data, standard deviations for surface temperatures segregated by months range from 0.8°F to 3.8°F. At Eniwetok, in the Marshall Islands, the standard deviations for surface temperatures range from 0.6°F to 1.6°F (Robinson, 1951, 1954, 1957).

#### METHOD OF ANALYSIS

The Makaroff and American ship data were analyzed together. These samples consist of individual observations widely and erratically distributed in space and time. From each of the sample temperatures the BT smoothed average monthly temperature for corresponding 1-degree (or 5-degree) square was subtracted. Thus a negative anomaly indicates that

the sample temperature was lower than the BT average.

The anomalies were tabulated into frequency distributions as follows: (a) 0.5°F class interval; (b) the total sample; (c) subsample by area: Northeast Pacific and Marshall Islands; (d) each area subsample was further subdivided by: 10-degree bands of longitude, 10-degree bands of latitude for the Northeast Pacific, by 5-degree bands of latitude in the Marshall Islands area; (e) subsample by time intervals of years and of months.

Table 9 lists symbols and equations used in statistical analysis of the frequency distributions of the anomalies.

TABLE 9

**SYMBOLS AND EQUATIONS USED IN STATISTICAL ANALYSIS**

$t$  = Sample temperature, 1 month, 1 year, unit area.\*

$\bar{t}_{BT}$  = Average BT temperature, corresponding month, year and area.

$n$  = Number of observations in 1 month, 1 year, all areas.

$N_y$  = Number of observations in all months, 1 year, all areas.

$N$  = Total sample, all months, years, areas.

$d$  =  $(t - \bar{t}_{BT})$ , anomaly, 1 month, 1 year, unit area.

$\bar{d}$  =  $\frac{\sum_A(t - \bar{t}_{BT})}{n}$ , anomaly, 1 month, 1 year, all areas.

$\bar{D}_y$  =  $\frac{\sum_y d}{N_y}$ , anomaly 1 year, all areas.

$\bar{D}$  =  $\frac{\sum d}{N}$ , anomaly all months, years, areas.

$rms_y$  =  $\frac{\sqrt{\sum_1^{N_y} (t - \bar{t}_{BT})^2 - (N_y \bar{D}_y)^2}}{N_y - 1}$ , root mean square deviation all months, 1 year, all areas.

$rms$  =  $\frac{\sqrt{\sum_1^N (t - \bar{t}_{BT})^2 - (N \bar{D})^2}}{N - 1}$ , root mean square deviation, all months, all years, all areas.

\* Unit area is 1-degree square of latitude and longitude, except where values are starred in Table 2. Here unit area was 5-degree square. In only one case were anomalies based on 1-degree and 5-degree square averages combined. This was in July, 1875 where 10 of the 22 values were based on 5-degree square averages.

The statistics of the anomalies were tested in the following way: (a) The frequency distributions were tested for normalcy. (b) The mean anomalies of total samples and all subsamples were tested to see if they departed significantly from zero, using  $\sigma\sqrt{n}$  as the significance criteria, assuming that the rms value computed for the total sample is a good estimate of  $\sigma$ . (c) The probabilities were computed that the given percentage of positive and negative anomalies could have occurred by chance, assuming that the BT mean temperatures and the 19th century mean temperatures were the same. The following method was used:

$p$  = probability of obtaining negative anomaly =  $\frac{1}{2}$   
 $q$  = probability of obtaining positive anomaly =  $\frac{1}{2}$   
 $n$  = number of observations  
 $\sigma$  =  $\sqrt{npq}$

$M = \frac{n}{2}$  = mean

$X$  = observed number of negative (or positive) anomalies

$t = \frac{X - M}{npq}$

For given values of  $t$ , the probability of obtaining such distributions is given in Table 1 of Hoel (1947). (d) The probability was computed that the observed distribution of monthly anomalies ( $\bar{d}$ ) might have occurred by chance, and the probability that the sign of the mean of the monthly anomalies ( $\bar{D}_y$ ) is the same as the true annual anomaly, assuming that the sign of each month's anomaly and the sign of each year's anomaly is an independent event.

The frequency distributions of the total samples were found to be leptokurtic; i.e. symmetrical but more sharply peaked and longer tailed than a normal distribution. The departure from normality was not great enough, however, to invalidate the probabilities which were computed on the assumption of normal distributions.

The Weather Bureau sample was treated in a somewhat different fashion. This sample consists of data limited in space to a 1-degree square of latitude and longitude. The data are not continuous for the total period of time between 1857 and 1955, although after 1916 there are data in almost all months of all years except for 1940, 1943 and 1944, where no data at all were listed.

The analysis of these data was based on the following statistics:

(a) The long-period monthly means and annual mean were computed. These were used as the base to compute monthly anomalies. The average of the available monthly anomalies in a given year was computed and assumed to be a best estimate of the annual anomaly for the given year.

(b) In the portion of the sample in the years 1941-1955, the standard deviation of individual observations was computed from the range (Tippett, 1925). This was possible because the range of the individual temperature values, and the number of observations on which the sample mean was based, was listed for this portion of the Weather Bureau sample. The values obtained for each month for the 14-year period were averaged, and these average monthly deviations were compared with the standard deviations computed in the usual manner, for each month for the BT data in Table 3.

(c) The significance of the monthly anomalies ( $\bar{d}$ ), assuming normal distribution, was tested; also, the probabilities were computed that the signs of the  $\bar{D}_y$ 's

were the same as the signs of the true annual anomalies.

(d) Correlation coefficients were computed between the Weather Bureau sea surface mean temperature anomalies, representing offshore oceanic conditions and San Francisco shore station mean sea surface temperature anomalies for both monthly and yearly periods.

(e) Correlation coefficients were computed between the Weather Bureau annual sea surface mean temperature anomalies and San Francisco annual air temperature anomalies.

(f) The significance of the computed correlation coefficients was tested using tables published by Fisher and Yates (1948).

o



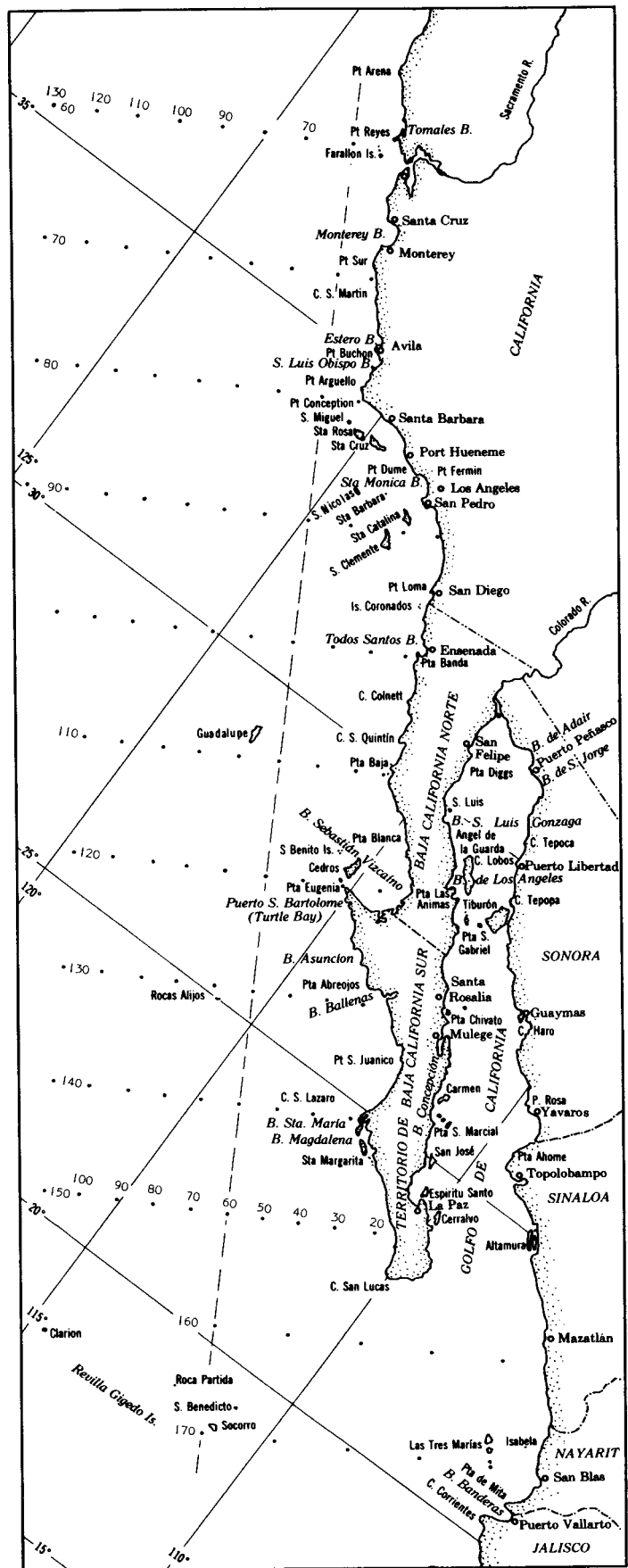
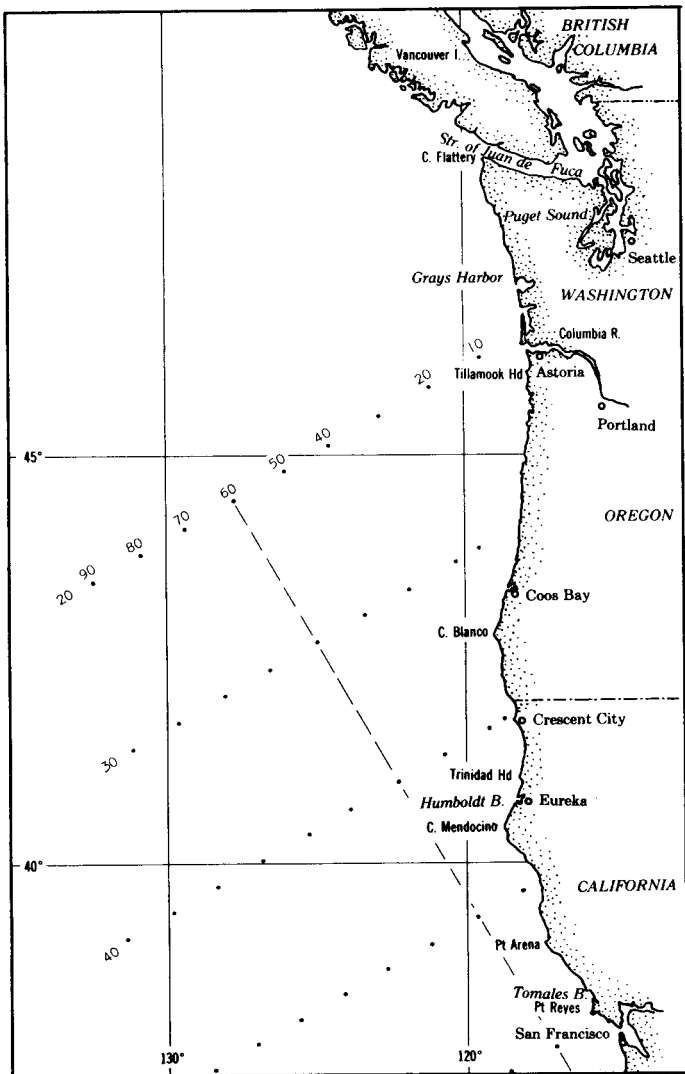

These maps are designed to show essential details of the area most intensively studied by the California Cooperative Oceanic Fisheries Investigations. This is approximately the same area as is shown in red on the front cover. Geographical place names are those most commonly used in the various publications emerging from the research. The cardinal station lines extending southwestward from the coast are shown. They are 120 miles apart. Additional lines are utilized as needed and can be as closely spaced as 12 miles apart and still have individual numbers. The stations along the lines are numbered with respect to the station 60 line, the numbers increasing to the west and decreasing to the east. Most of them are 40 miles apart, and are numbered in groups of 10. This permits adding stations as close as 4 miles apart as needed. An example of the usual identification is 120.65. This station is on line 120, 20 nautical miles southwest of station 60.

The projection of the front cover is Lambert's Azimuthal Equal Area Projection. The detail maps are a Mercator projection. Art work by George Mattson, U. S. Bureau of Commercial Fisheries.

## CONTENTS

	Page
I. Review of Activities	
1. Review of Activities July 1, 1962-June 30, 1963	1
2. Review of pelagic wet fisheries during the 1960-61 season	8
3. Publications	10
II. Scientific Contributions	
1. Symposium on larval fish biology	12
Preface	12
a. On the importance of larval survival for the population dynamics of marine food fish Gotthilf Hempel	13
b. Problems of fish larvae survival in nature and the rearing of economically important middle European freshwater fishes Wilhelm Einsele	24
c. Kinds and abundance of fishes in the California Current region based on egg and larval surveys Elbert H. Alstrom	31
d. Rearing marine fish for commercial purposes James E. Shelbourne	53
e. Functional development of visual pathway in larval sardines and anchovies Horst O. Schuassman	64
f. Some aspects of behavior in clupeid larvae George O. Schumann	71
g. The feeding of herring larvae and their ecology in relation to feeding J. H. S. Blaxter	79
h. Osmoregulation in marine teleost eggs and larvae F. G. T. Holliday	89
i. The physiology of Pacific sardine embryos and larvae Reuben Lasker	96
j. Larval sardine and anchovy interrelationships John D. Isaacs	102
2. Climatic implications derived from the comparison of bathythermograph (BT) data with two types of historic and modern sea surface data Margret K. Robinson	141